

ENGLISH

**IP-420
INPUT INSTRUCTION MANUAL**

CONTENTS

1. START AND END OF THE BODY INPUT MODE	1
1-1. Move to the body input mode.....	1
1-2. Return to the normal sewing mode	4
2. BASIC OPERATION AND DISPLAY	5
2-1. Common button.....	5
2-2. Body input mode standard screen	6
2-3. Selection of function	10
2-4. Input the numeric value	11
2-5. Specifying the position	12
3. EXAMPLE OF OPERATING PROCEDURE	14
3-1. Pattern input	14
3-2. Trial sewing	17
3-3. Modification of the pattern	18
3-4. Pattern writing	21
3-5. Pattern reading	22
4. INPUT OF PATTERN	23
4-1. Ordinary sewing	23
(1) Jump feed (020).....	23
(2) Linear ordinary sewing (023)	25
(3) Spline ordinary sewing (024)	27
(4) Arc ordinary sewing (025).....	29
(5) Circle ordinary sewing (026)	30
(6) Point sewing (021).....	31
(7) Ordinary sewing (022).....	32
4-2. Zigzag sewing (030 to 033)	33
4-3. Offset sewing (034 to 037)	35
4-4. Double sewing	37
(1) Double orderly sewing (040 to 043).....	37
(2) Double reverse sewing (044 to 047).....	39
(3) Overlapped reverse sewing (050 to 053).....	40
4-5. Machine control command	42
(1) Thread trimming (001)	42
(2) The 2nd origin (002).....	42
(3) Stop (003)	43
(4) One revolution of sewing machine (006)	44
(5) Mark 1 and mark 2 (008, 009).....	45
(6) Thread tension controller No. 3 (007)	45
(7) Delay (010)	46
(8) External input (011).....	46
(9) External output (012)	47

(10) Enlargement/reduction reference point (004)	48
(11) Inversion point (005)	49
(12) Thread tension setting (014)	50
(13) Intermediate presser height setting (018)	51
(14) Area Classification (016)	52
(15) Sewing machine stop (019)	53
(16) Machine control command deletion (059)	54
(17) Sewing speed (092)	54
4-6. Automatic back-tack (064)	55
4-7. Condensation sewing (065)	56
4-8. Overlapped sewing (066)	57
4-9. Breakpoint (spline and ordinary sewing)	58
5. MODIFICATION OF THE PATTERN	61
5-1. Point modification	61
(1) Point deletion (070 and 074)	61
(2) Point move (071 and 075)	63
(3) Point adding (076)	65
5-2. Vertex modification	67
(1) Vertex deletion (072 and 077)	67
(2) Vertex move (073 and 078)	68
5-3. Element deletion (063)	69
5-4. Jump feed speed change (060)	70
5-5. Sewing speed section change (061)	71
5-6. Sewing pitch change (062)	72
5-7. Symmetry	73
(1) X-axis symmetry (082)	73
(2) Y-axis symmetry (083)	73
(3) Point symmetry (084)	74
(4) Y symmetry pattern inversion orderly sewing (098)	74
5-8. Shape point modification	75
(1) Shape point adding (135)	75
(2) Shape point move (136)	77
(3) Shape point deletion (137)	78
6. PATTERN OPERATION	80
6-1. Pattern copy (086)	80
6-2. Pattern move (085)	81
6-3. Pattern erase (087)	82
6-4. Pattern reading	83
(1) Read the pattern data	83
(2) Set the enlargement/reduction ratio	85
(3) Set the kind of reading data	87
6-5. Pattern writing	89
(1) Write the pattern data	89

7. FORMATTING MEDIA (090)	90
8. TRIAL SEWING	91
8-1. Preparing the trial sewing.....	91
8-2. Performing the trial sewing	93
9. SETTING FUNCTION	95
9-1. Comment input	95
9-2. Clamp inversion setting (091)	96
9-3. Thread tension reference value setting (113)	96
9-4. Intermediate presser height reference value setting (115)	97
10. SELECTING ENDING PROCEDURE (110)	98
11. ALLOCATING FUNCTIONS TO F1 THROUGH F5 BUTTONS (112)	99
12. DISPLAYING DETAILED INFORMATION ON THE SET VALUE (093)	101
13. DISPLAYING DETAILED INFORMATION ON THE CURRENT NEEDLE POSITION	103
14. PERFORMING SETTING OF DISPLAY	105
15. ELEMENT FORWARD/BACKWARD (130 and 131)	109
16. DIRECT INSTRUCTIONS BY TOUCHING THE SCREEN	110
16-1. Coordinate direct instructions	110
16-2. Needle entry/shape points direct instructions	112
17. PERFORMING SETTING OF THE MEMORY SWITCH DATA	113
17-1. Setting of the memory switch data is performed	113
17-2. Change over the display language	114
17-3. Changing the display color of the current point	115
17-4. Setting the zigzag sewing output method.....	116
18. SELECTING THE FUNCTION CODE TO BE DISPLAYED	117
19. FUNCTION CODE LIST	118
20. SETTING RANGE LIST	126
21. BACKUP	130
22. ERROR CODE LIST	131
23. MESSAGE LIST	134

1. START AND END OF THE BODY INPUT MODE

1-1. Move to the body input mode

<Data input screen>

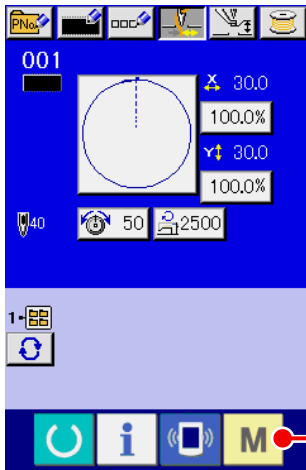

AMS-E series

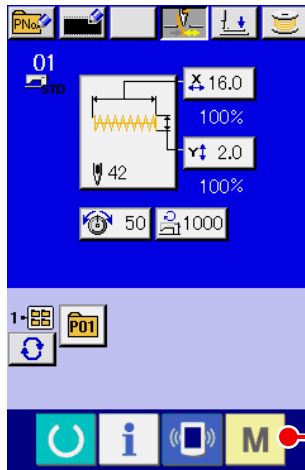

LK-1900B series

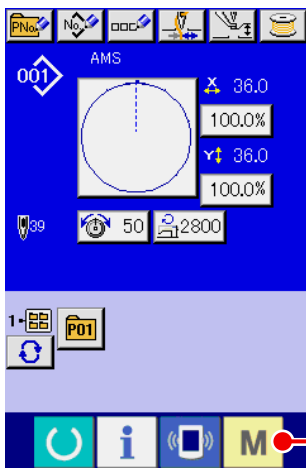

AMS-EN series

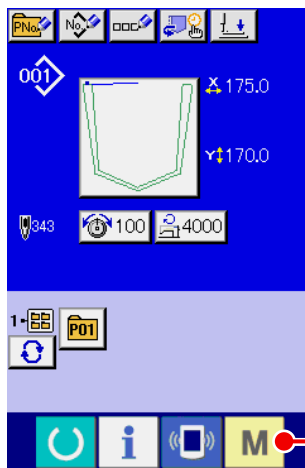

AP series

- ① **Turn ON the power switch.**
When the power switch is turned ON, the data input screen of the normal sewing mode is displayed after the welcome screen was displayed.
- ② **Display the mode screen.**
In order to move from the normal sewing mode to the body input mode, press MODE button **M** **A** to display the mode screen in the state that the data input screen of the normal sewing screen is displayed.

<Mode screen>

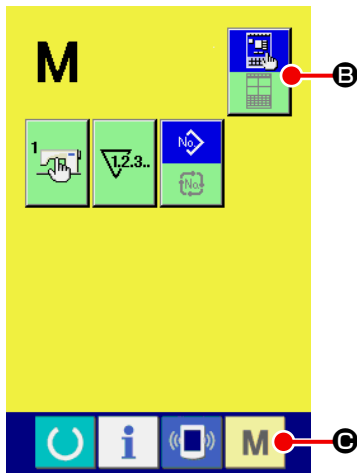

AMS-E series

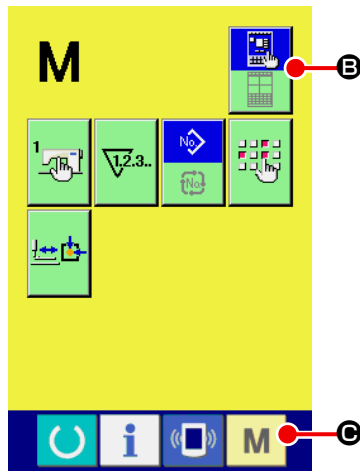

LK-1900B series

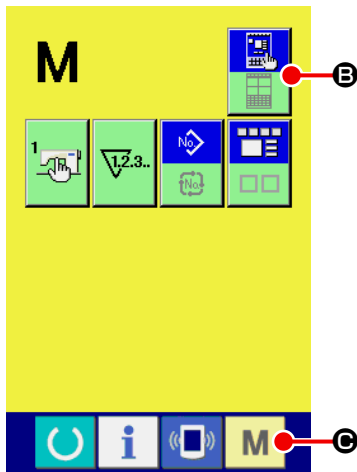

AMS-EN series

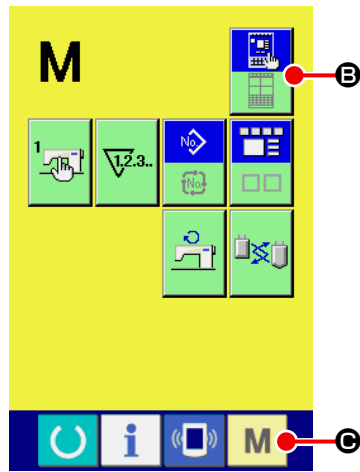



AP series

③ **Select the body input mode.**
Press MODE SELECTION

button  **B** to change over

the display from the normal sewing mode selection state

 to the body input mode

selection state .

④ **Move to the body input mode.**

When MODE button  **C** is pressed in the state that the body input mode is selected, the mode moves to the body input mode, and the backup data use confirmation screen is displayed.

* **For LK-1900B series, the standard screen is directly displayed.**

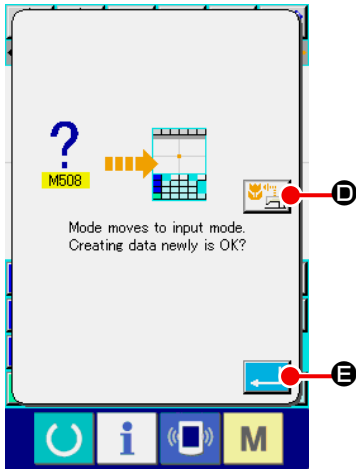

⑤ **Select the sewing data use.**

When SEWING DATA USE button  **D** is pressed, the body input mode standard screen is displayed in the state that the backup data is used.

When ENTER button  **E** is pressed, new creation can be performed.

<Standard screen>

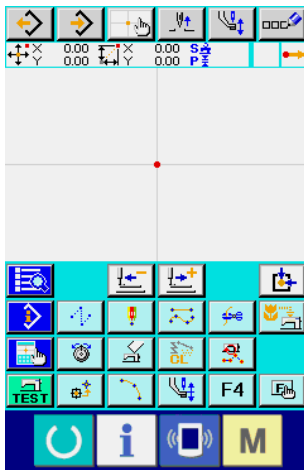

AMS-E series

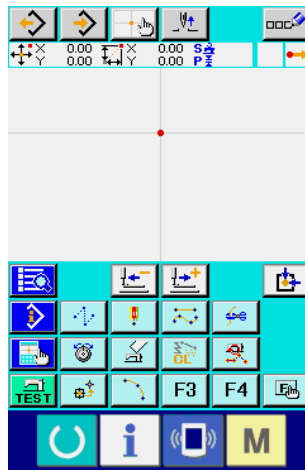

LK-1900B series



AMS-EN series



AP series

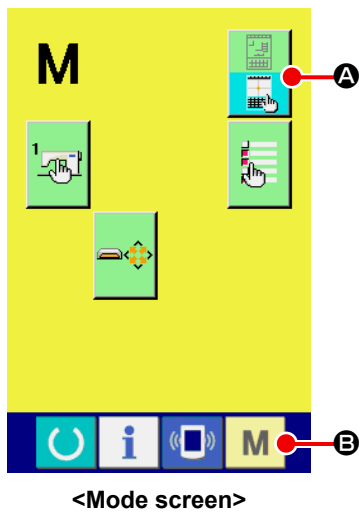

1-2. Return to the normal sewing mode



① Display the mode screen.

In order to return from the body input mode to the normal sewing mode, press MODE button **M** in the 6standard screen to display the mode screen.

② Select the normal sewing mode.

Press MODE SELECTION button  **A**, and change over the display from body input mode selection state  to normal sewing mode selection state .

③ Change over to the normal sewing mode.

When MODE button **M** **B** is pressed in the state that the normal sewing mode is selected, the sewing mode move confirmation screen is displayed. Here, when ENTER button  **C** is pressed, the data input screen of the normal sewing mode is displayed.

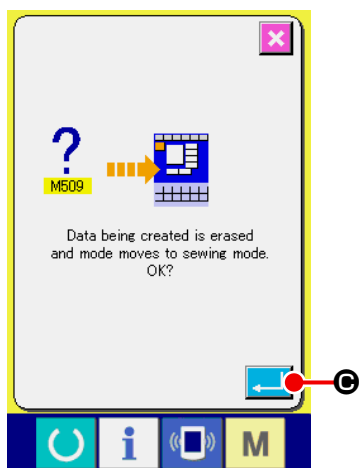











When the mode moves to the normal sewing mode, the data during creating is erased. When the data is necessary, perform writing before moving.

2. BASIC OPERATION AND DISPLAY

Explanation is given for the operation and the display which are common to the body input mode.

2-1. Common button

Buttons that perform common operation in the respective screens of the body input mode are as shown in the list below.

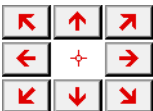
Button	Name of button	Description
	ENTER button	Executes the selected function. In case of the data change screen, the changed data is determined.
	CANCEL button	Closes pop-up screen. In case of the data change screen, the data being changed is destroyed.
	UP SCROLL button	Scrolls the button or display upward.
	DOWN SCROLL button	Scrolls the button or display downward.
	RESET button	Performs the release of error.
	NUMERAL INPUT button	Ten-key screen is displayed, and input of numeral can be performed.
	INTERMEDIATE PRESSER UP/DOWN button	Every time this button is pressed, intermediate presser is moved to the position of up ⇒ medium ⇒ down. Medium position : Maximum position of the setting of the sewing machine Down position : Input position of intermediate presser command * For LK-1900B series, this screen is not displayed.
	UP POSITION (UP DEAD POINT) RETURN button	Returns needle position to UP position (upper dead point). (Return position depends on the setting of the sewing machine.)
	COORDINATE DIRECT INSTRUCTIONS button	Coordinate direct instructions screen is displayed. → Refer to "16. DIRECT INSTRUCTIONS BY TOUCHING THE SCREEN" p.110.
	TEN key	Numeral corresponding to the pressed key is inputted. + and - buttons can increase or decrease the inputted numeric value.
	MOVE key	The specified position can be moved to the direction corresponding to the pressed move key.





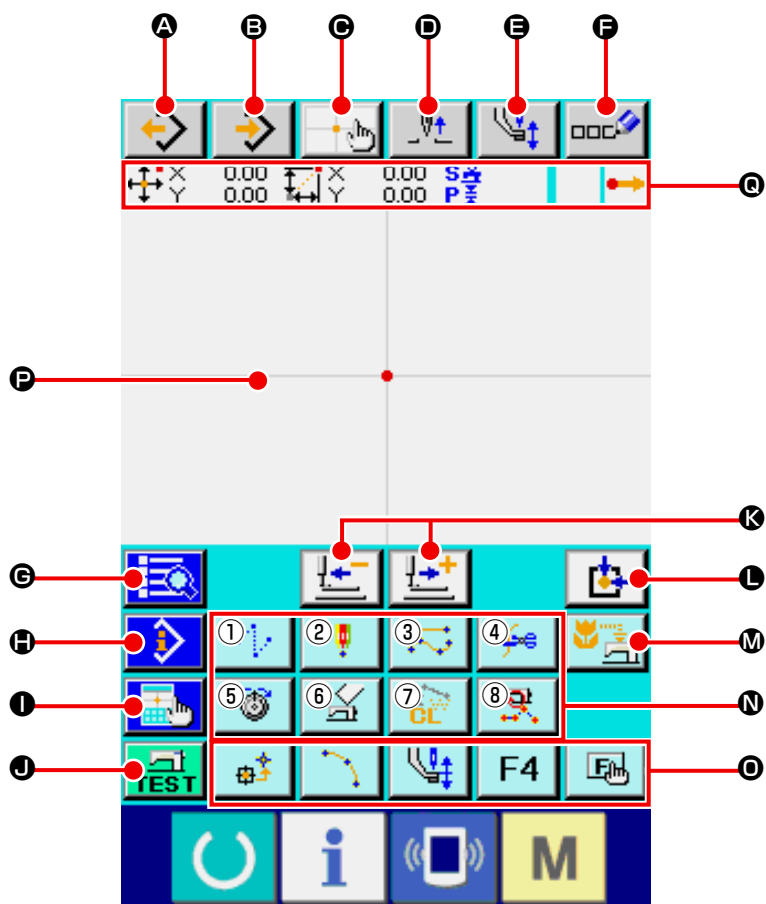









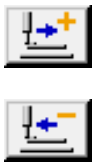



2-2. Body input mode standard screen













The standard screen of the body input mode is as shown below.











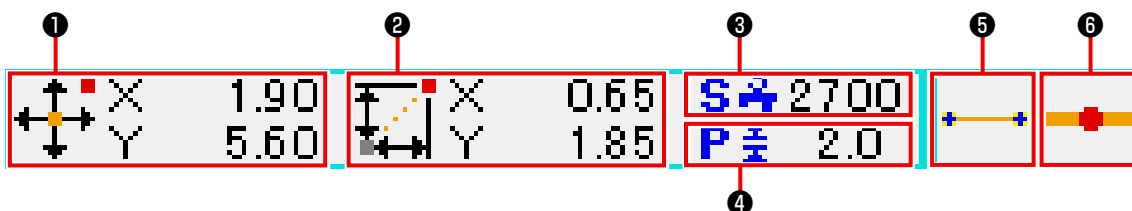











Buttons of the body input mode standard screen are as shown in the list below.

	Button	Name of button	Description
A		PATTERN READ button	Pattern reading screen is displayed. → Refer to "6-4. Pattern reading" p.83.
B		PATTERN WRITE button	Pattern writing screen is displayed. → Refer to "6-5. Pattern writing" p.89.
C		COORDINATE DIRECT INSTRUCTIONS button	Coordinate direct instructions screen is displayed. → Refer to "16-2. Needle entry/shape points direct instructions" p.112.
D		UP POSITION (UP DEAD POINT) RETURN button	Returns needle position to UP position (upper dead point). (Return position depends on the setting of the sewing machine.)
E		INTERMEDIATE PRESSER UP/DOWN button	Every time this button is pressed, intermediate presser is moved to the position of up ⇒ medium ⇒ down. Medium position : Maximum position of the setting of the sewing machine Down position : Input position of intermediate presser command * For LK-1900B series, this screen is not displayed.
F		COMMENT INPUT button	Comment input screen is displayed. → Refer to "9-1. Comment input" p.95.

	Button	Name of button	Description
Ⓒ		CODE LIST button	Code list screen is displayed. → Refer to " 2-3. Selection of function " p.10.
Ⓗ		CONTENTS DISPLAY button	Contents display screen is displayed, and detailed information on the present needle position is displayed. → Refer to " 13. DISPLAYING DETAILED INFORMATION ON THE CURRENT NEEDLE POSITION " p.103.
Ⓘ		DISPLAY SETTING button	Display setting screen is displayed. → Refer to " 14. PERFORMING SETTING OF DISPLAY " p.105.
Ⓢ		TRIAL SEWING button	Trial sewing screen is displayed. → Refer to " 8. TRIAL SEWING " p.91.
Ⓚ		FEED FORWARD/ BACKWARD button	Moves the present needle position by one stitch (forward  and backward ). The mode becomes the continuous move mode when holding pressing a fixed number of stitches.
Ⓛ		RETURN TO ORIGIN button	Returns present needle position to the origin.
Ⓜ		BACKUP button	Performs backup of pattern data to sewing machine. (Caution : Overwriting is performed on the present pattern data. When the pattern data is selected from the media in the normal sewing mode or the users' pattern is being edited, the data will disappear.) * For LK-1900B series, this screen is not displayed.
Ⓝ		FUNCTION button	Function allocated to the button can be directly called.
		① 	Executes jump feed (" 4-1.(1) Jump feed (020) " p.23).
		② 	Executes point sewing (" 4-5.(6) Point sewing (021) " p.31).
		③ 	Executes normal sewing (" 4-1.(7) Ordinary sewing (022) " p.32).
		④ 	Executes thread trimming (" 4-5.(1) Thread trimming (001) " p.42).
		⑤ 	Executes thread tension setting (" 4-5.(12) Thread tension setting (014) " p.50).
		⑥ 	Executes machine control command deletion (" 4-5.(16) Machine control command deletion (059) " p.54).
		⑦ 	Executes element deletion (" 5-3. Element deletion (063) " p.69).
⑧ 	Executes sewing speed section change (" 5-5. Sewing speed section change (061) " p.71).		

	Button	Name of button	Description										
Ⓞ		F button	The function you desire can be allocated to each button by means of function selection and setting (function code 112), and this button can be used as the function button. When the function is allocated, pictograph showing the allocated function is displayed. → Refer to " 11. ALLOCATING FUNCTIONS TO F1 THROUGH F5 BUTTONS (112) " p.99.										
Ⓟ		PATTERN DISPLAY REGION	Part where pattern is displayed. When pressing down this button, screen scrolls so that the point becomes the center position of the display. Screen does not scroll when the outside of sewing area is pressed. <table border="1" data-bbox="687 555 1422 831"> <thead> <tr> <th>Kind of point</th> <th>Display color</th> </tr> </thead> <tbody> <tr> <td>Current point</td> <td> : Red</td> </tr> <tr> <td>3 stitches in the direction of sewing start</td> <td> : Yellow</td> </tr> <tr> <td>3 stitches in the direction of sewing end</td> <td> : Yellow-green</td> </tr> <tr> <td>Others</td> <td> : Gray</td> </tr> </tbody> </table>	Kind of point	Display color	Current point	 : Red	3 stitches in the direction of sewing start	 : Yellow	3 stitches in the direction of sewing end	 : Yellow-green	Others	 : Gray
Kind of point	Display color												
Current point	 : Red												
3 stitches in the direction of sewing start	 : Yellow												
3 stitches in the direction of sewing end	 : Yellow-green												
Others	 : Gray												
Ⓠ		PRESENT NEEDLE POSITION INFORMATION display	Part where information on the present needle position is displayed. Contents of the display is shown below.										



	Item	Description															
①	Absolute coordinate	Absolute coordinate from the origin of the present needle position is displayed.															
②	Relative coordinate	Relative coordinate of the present needle position is displayed.															
③	Speed	Sewing speed or jump feed speed of the present point is displayed.															
④	Pitch	Stitch length of the present element is displayed. (When performing reading after enlarging/reducing, the value before enlarging/reducing is displayed.)															
⑤	Kind of element	Kind of element of present element is displayed. In case of sewing data, pictograph in accordance with the kind of element (jump feed  , broken line  , spline  , etc.) is displayed. In case of machine control command, kind of machine control command (thread trimming  , etc.) is displayed with pictograph. (For the other pictographs, refer to "19. FUNCTION CODE LIST" p.118.)															
⑥	Kind of needle entry	Kind regarding needle entry position is displayed. <table border="1" data-bbox="534 996 1444 1422"> <tbody> <tr> <td></td> <td>Top of pattern</td> <td>Top position (origin) of pattern is displayed.</td> </tr> <tr> <td></td> <td>Midway of element</td> <td>Point of midway in element (not the top nor end of element) is displayed.</td> </tr> <tr> <td></td> <td>Top</td> <td>Top of broken line is displayed.</td> </tr> <tr> <td></td> <td>End of element</td> <td>End position of element is displayed.</td> </tr> <tr> <td></td> <td>End of pattern</td> <td>The last position of pattern is displayed.</td> </tr> </tbody> </table>		Top of pattern	Top position (origin) of pattern is displayed.		Midway of element	Point of midway in element (not the top nor end of element) is displayed.		Top	Top of broken line is displayed.		End of element	End position of element is displayed.		End of pattern	The last position of pattern is displayed.
	Top of pattern	Top position (origin) of pattern is displayed.															
	Midway of element	Point of midway in element (not the top nor end of element) is displayed.															
	Top	Top of broken line is displayed.															
	End of element	End position of element is displayed.															
	End of pattern	The last position of pattern is displayed.															

The section of present needle position information display can display the comment of pattern by the display setting ("14. PERFORMING SETTING OF DISPLAY" p.105) as well.

2-3. Selection of function

Procedure of the function selection of the body input mode is given below.

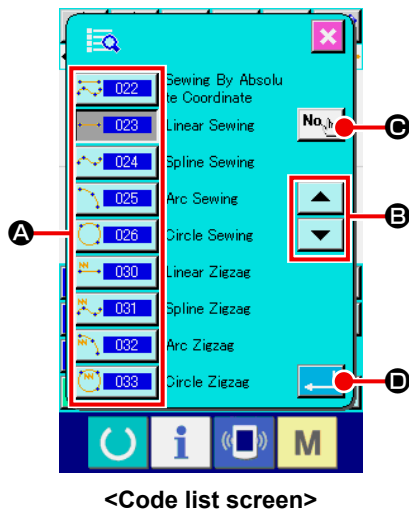

① Display the code list screen.

When CODE LIST button  is pressed in the standard screen of the body input mode, the code list screen is displayed.

② Select the function.

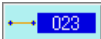
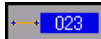

Press the calling button of the function you desire to execute from among the function calling button list **A**. The selected function calling button  is changed to .

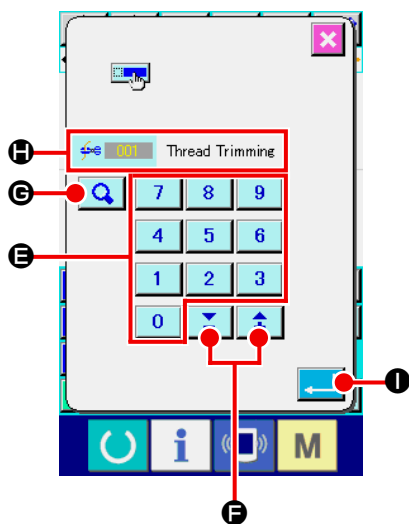
When UP/DOWN SCROLL button  **B** is pressed, the display of function calling button list **A** is changed over in order.



③ Direct input the function code.

When FUNCTION CODE INPUT button  **C** is pressed, the function code input screen is displayed and the function code can be direct inputted.

Direct input the function code with TEN KEYS  **E**, or select the function code with + or - button  **F**.

When CONFIRMATION button  **G** is pressed, the information on the function corresponding to the inputted function code is displayed in the function name display column **H**.

When the function code you desire to execute is inputted and ENTER button  **I** is pressed, the screen returns to the function code list screen with inputted function selected.

④ Execute the function.

When ENTER button  **D** is pressed with the function calling button of the function you desire to execute selected, setting screen of the function is displayed.

For the respective setting screens, refer to the items of the respective functions.

2-4. Input the numeric value

Common numeric value input procedure at the time of creating the pattern data is given below.

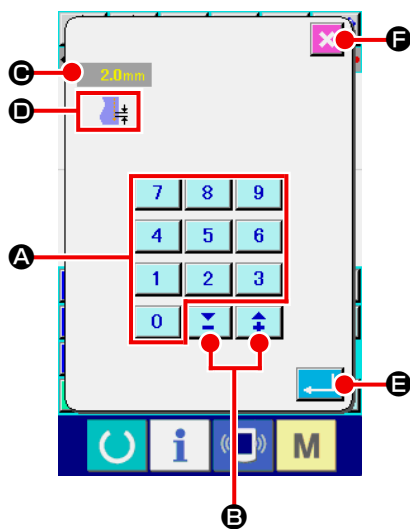

① Input the setting item.

The figure on the right-hand side is the screen which is displayed when inputting the set value of setting item of the function.

[Example : Change of stitch length]

Kind of setting item to be inputted is displayed at **D** and the input value is displayed at **C**.

When TEN KEY **0** to **9** **A** is pressed, the numeral of the pressed ten key is inserted to the 1st digit of **C**, and the previous input values are moved up by one digit each. In addition, the input value can be increased or decreased with + or - button **B**. Changeable unit depends on the kind of setting item.

When ENTER button **E** is pressed, the input value is determined and the screen moves.

When CANCEL button **F** is pressed, the input value is destroyed and the screen moves.

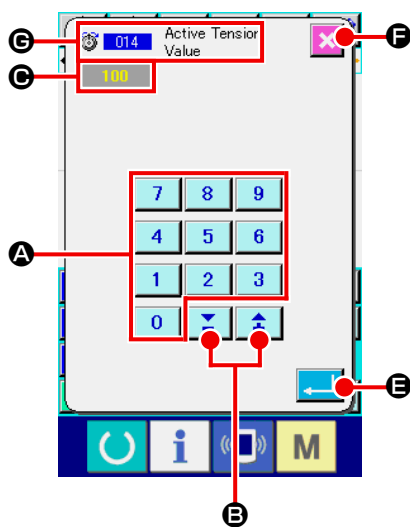

② Input the machine control command parameter.

The figure on the left-hand side is the screen which is displayed when inputting the parameter of machine control command.

Inputting procedure is the same as that of inputting the set value of the setting item. At **E** the function code to perform the input of parameter and the function name are displayed.

2-5. Specifying the position

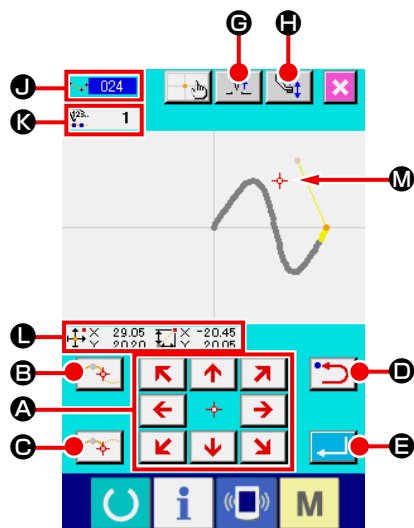



The figure on the right-hand side is the position specifying screen which is displayed when specifying the position at the setting of function. The selected function code is displayed at **J**.

- ① Press **MOVE** key  **A**.

The presser and the present needle position display 

M move in the pressed direction, and the coordinate value display **L** is updated. While MOVE key is held pressed, the presser moves in the pressed direction, and when it is detached, the move of presser stops.

When the presser moves to the target position and **PASSING POINT** button  **B** or **DECIDING POINT** button 

C is pressed, the position is inputted as the shape point or the needle entry point. At **K** the number of input points is displayed. **PASSING POINT** button  **B** may not be displayed according to the selected function.

- ② Press **BACKWARD** button  **D** after moving with **MOVE** key.

The position returns to the preceding determined position.

When it is pressed immediately after the determination of input position, one point of the determined input points is cancelled and the position returns to the input point before one point.

- ③ Press **ENTER** button  **E**.

The outer presser automatically returns to the position where input was started, traces the element which was operated and created at the input point inputted until then, moves to the last of the element, and the data is inserted.

(With/without trace can be selected. For the details, refer to "[10. SELECTING ENDING PROCEDURE \(110\)](#)" p.98.)



④ Press **CANCEL** button  **I**.

The data during inputting is destroyed, and the screen returns to the standard screen.

By pressing ENTER button at inputting of the last point, pressing down of the deciding point button can be omitted.

⑤ Press **COORDINATE DIRECT INSTRUCTIONS** button 

F.

The coordinate direct instructions screen ("16-1. Coordinate direct instructions" p.110) is displayed, and the coordinate can be direct specified.

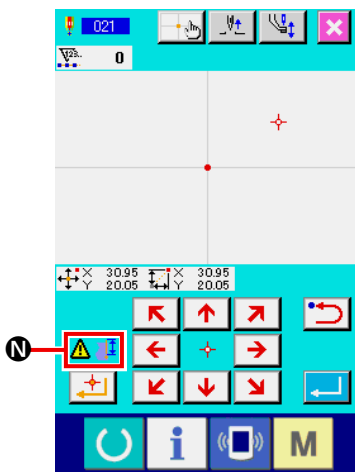

At **N** warning pictograph  is displayed when setting possible range is exceeded or the like.

3. EXAMPLE OF OPERATING PROCEDURE

A series of operating procedure up to trial sewing is given below. For the details, refer to the respective items.

3-1. Pattern input

Create the pattern below using the input function.

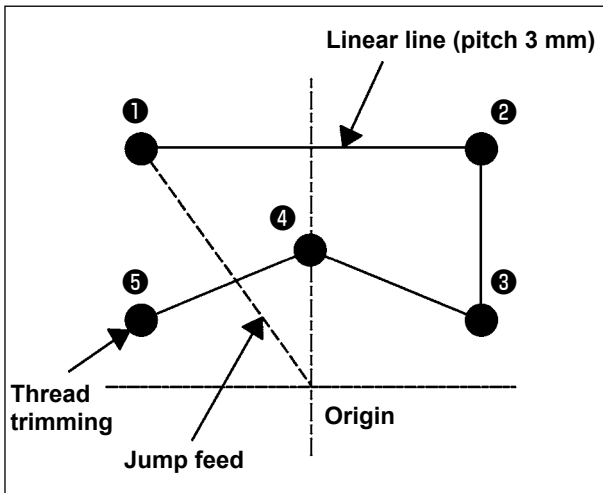

[Input point]

	X(mm)	Y(mm)
①	-5.0	5.0
②	5.0	5.0
③	5.0	1.0
④	0.0	3.0
⑤	-5.0	1.0

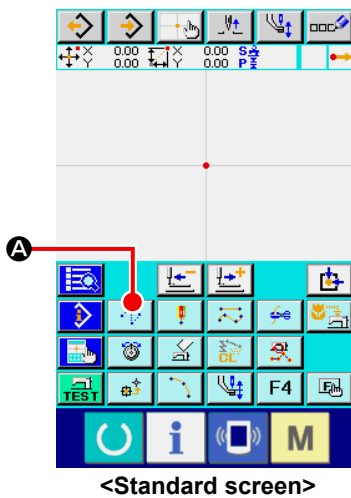

① Input of jump feed

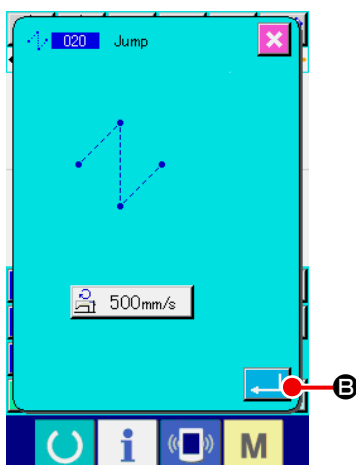

Press JUMP FEED button  **A** in the standard screen to display the jump feed setting screen.

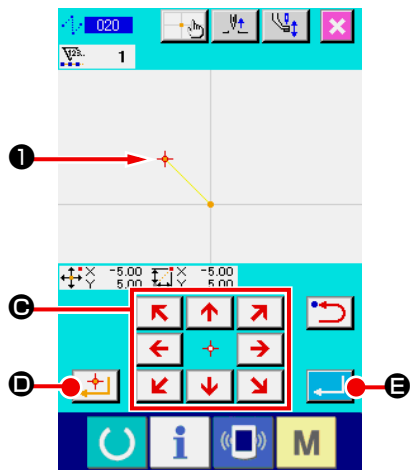

Press ENTER button  **B** in the jump feed setting screen to display the jump feed position specifying screen.



Move the needle position up to ① using MOVE key 

② in the jump feed position specifying screen, press DECIDING POINT button  ③, and press ENTER button  ④.



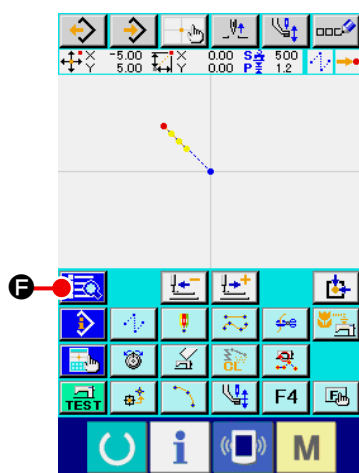

At this time, the presser moves. So, be careful.



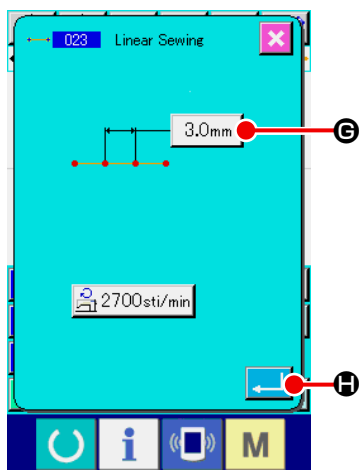

② Input of the linear ordinary sewing

Press CODE LIST button  ⑤ in the standard screen to display the code list screen.



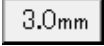



Select the linear ordinary sewing (function code 023) in the function code list screen, and press ENTER button .

Press STITCH LENGTH SETTING button  ⑥ in the linear ordinary sewing setting screen to display the stitch length setting screen.

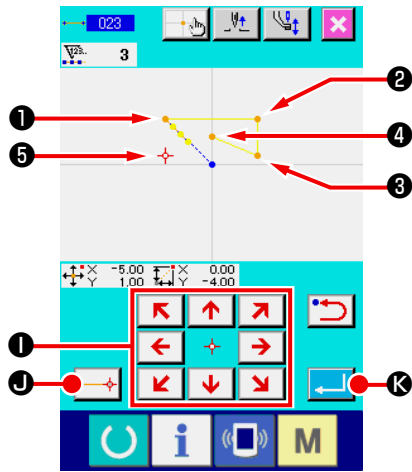
Press TEN key in the order of “3” and “0”, and press ENTER button  in the stitch length setting screen.

Return to the linear ordinary sewing setting screen, confirm that the display of stitch length setting button is “3.0 mm”, and press ENTER button  ⑦.



Press MOVE key  ① in the linear ordinary sewing position specifying screen, move the needle position from ① to ②, and press DECIDING POINT button  ④. Repeat this operation to input up to the position of ⑤, and press ENTER button  ⑥.

 **At this time, the presser moves. So, be careful.**

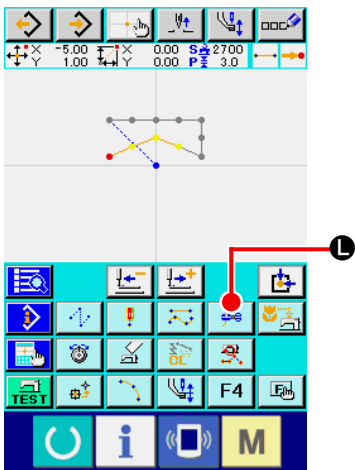

③ Input of thread trimming

Press THREAD TRIM button  ⑦ in the standard screen to display the thread trimming confirmation screen.

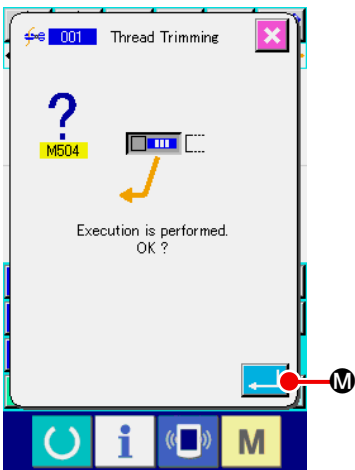

Press ENTER button  ⑧ and input thread trimming to the position of ⑤.

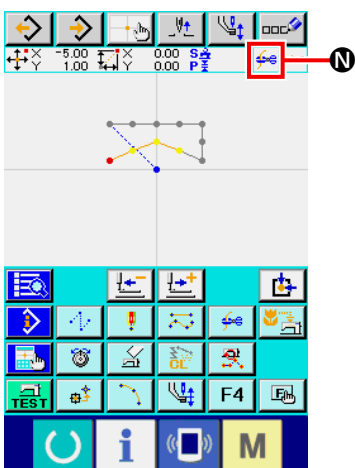

The standard screen is displayed, and  is displayed at ⑨.

With the aforementioned operation, a pattern as shown in the figure on the left-hand side is created.

3-2. Trial sewing

The shape or the like of the pattern created by using the input function or readout data is confirmed with the trial sewing.

Screen and setting possible item of trial sewing change in accordance with machine models.

Description below is the example regarding AMS-210EN.



Before performing the trial sewing, it is necessary to register the setting of the height of intermediate presser and that of the thread tension.

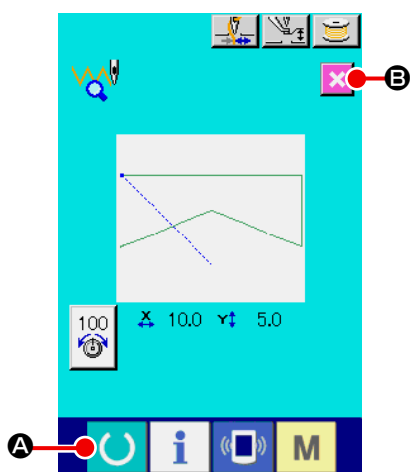

① **Display the trial sewing preparation screen.**



Press TRIAL SEWING button  in the standard screen to display the trial sewing preparation screen.

② **Display the trial sewing screen.**

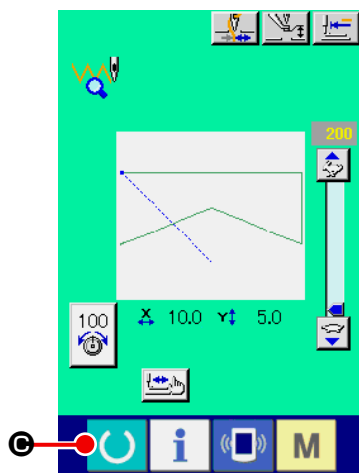
When SEWING PREPARATION button  **A** is pressed, the trial sewing screen is displayed. Perform the normal sewing machine operation in this screen and the trial sewing of pattern data can be performed.



③ **Return to creation of pattern.**

When SEWING PREPARATION button  **C** is pressed in the trial sewing screen, the screen returns to the trial sewing preparation screen. When CANCEL button  **B** is pressed here, the screen returns to the body input mode standard screen.

3-3. Modification of the pattern

Modify the pattern data which has been created in "3-1. Pattern input" p.14.

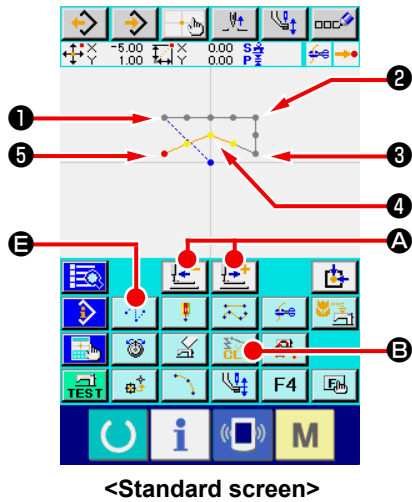

① Deletion of element

Move the needle position on the way of the jump feed section up to ① using FEED FORWARD/BACKWARD buttons



Press ELEMENT DELETION button ⑤ in the standard screen, and press ENTER button ⑥ in the confirmation screen.

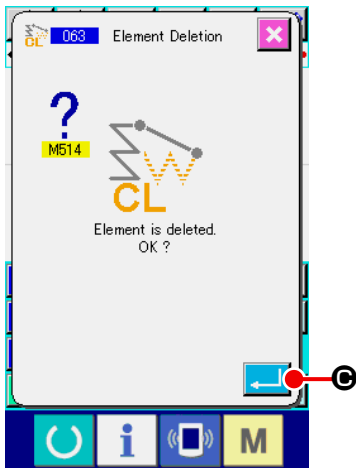

Jump feed up to ① is deleted, and the needle position returns to the origin.

At this time, linear sewing from ① through ⑤ is in the state of starting from the origin.

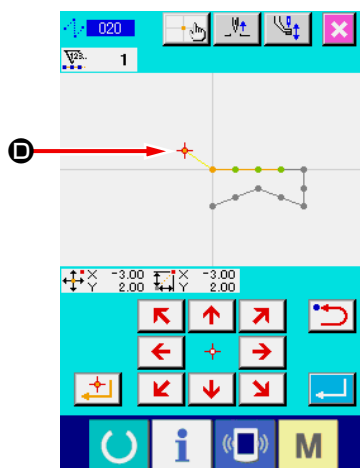
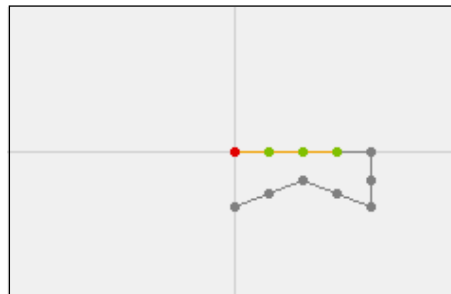

② Insertion of jump feed

Select the jump feed function ⑤ on the standard screen. Move the needle position to ④ on the position specifying screen.

Press button ⑥.

It can be visually checked that a jump is inserted and the relative movement of the needle position is caused.

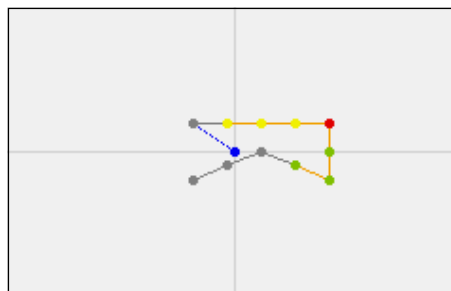

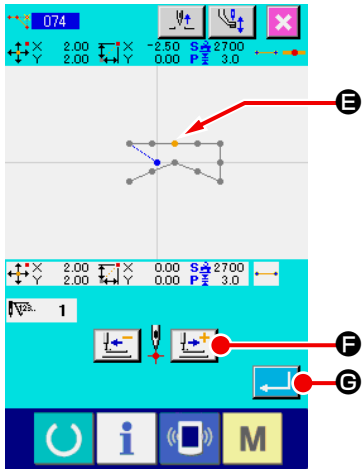



③ Deletion of point

Move the needle position up to the position of **E** in the standard screen using FEED FORWARD/BACKWARD buttons

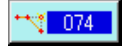

Select ABSOLUTE POINT DELETION (function code 074)  from the function code list to display the range specifying screen.

In case of deleting plural needle entry points, press FEED FORWARD button  **F** to move the needle position, and specify the section of the points to be deleted. Here, specify point **E** only, and press ENTER button  **G**.

It is confirmed that point **E** has been deleted as shown in the figure below.

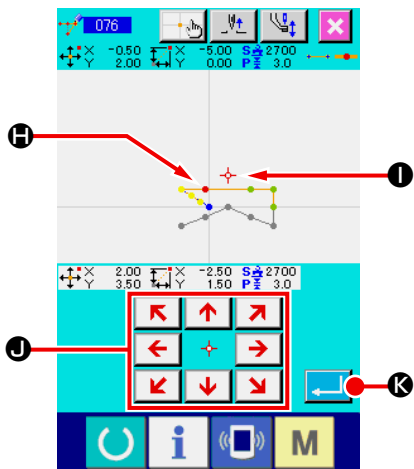
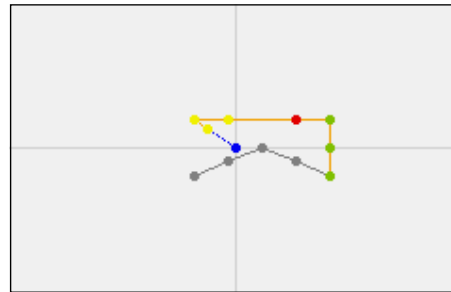



④ Addition of point

Move the needle position up to the position of **H** in the standard screen using FEED FORWARD/BACKWARD buttons

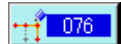

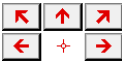
and select ABSOLUTE POINT ADDITION (function code 076) .

Move the needle position up to the adding point **I** in the position specifying screen using MOVE key  **J**, and

press ENTER button  **K**.

The needle entry point is added as shown in the figure below.

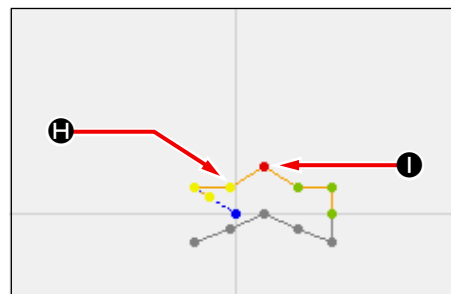

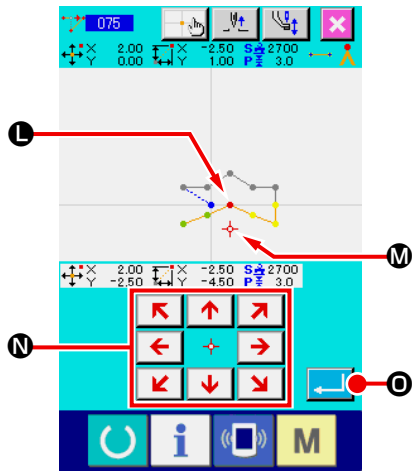

⑤ Move of point

Move the needle position up to the position of **L** in the standard screen using FEE FORWARD/BACKWARD buttons

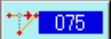

A, and select ABSOLUTE POINT MOVE (function code 075) .

Move the needle position up to the position **M** of the moving point in the position specifying screen using MOVE key

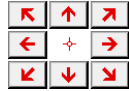



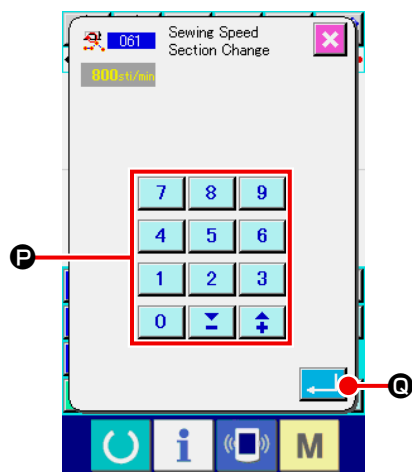
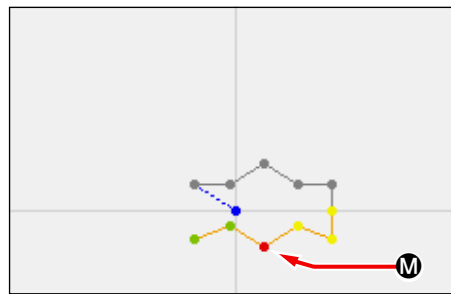

N, and press ENTER button .

The needle entry point moves as shown in the figure below.

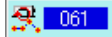

⑥ Change of speed

After moving the needle position up to the position of **3** in the standard screen, select SEWING SPEED SECTION CHANGE (function code 061) .

Input the changing speed (example here is 800 rpm) in the set value input screen using TEN keys  to  **P**, and press ENTER button  **Q**.

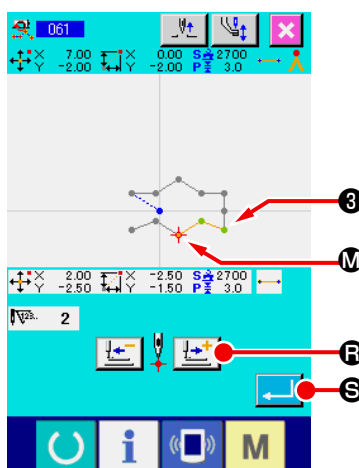

Press FEED FORWARD button  **R** in the position

specifying screen, and move the needle position up to section **M** you desire to change the speed.

When ENTER button  **S** is pressed, the speed of the specified section is changed, and the screen returns to the standard screen.

3-4. Pattern writing

The created pattern is written to the media.



Use the media which has been formatted with IP-420.

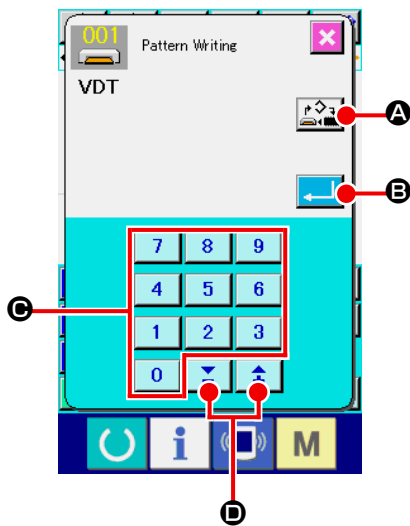

① **Display the pattern writing screen.**

Press WRITE button  in the standard screen to display the pattern writing screen.

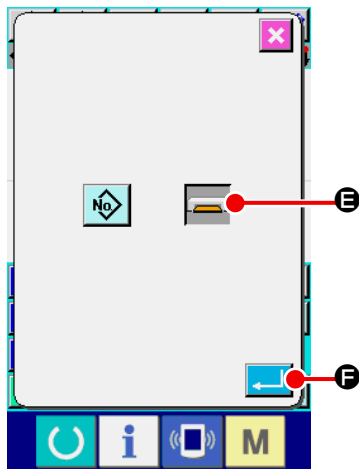

② **Select the object media selection screen.**

Press OBJECT MEDIA SELECTION button  **A** to display the object media selection screen.





③ **Select the object media.**

Select the media of writing object. Here select MEDIA  **E**.

The selected media is changed in color . When the media is selected, press ENTER button  **F** to return to the pattern writing screen.

④ **Select pattern No.**

Press TEN key  **0** to  **9** **C**, or + or - button  **D** in the pattern writing screen to specify the pattern No. which is open next.

⑤ **Write pattern.**

When ENTER button  **B** is pressed, writing to the media is started. When writing is ended, the standard screen is displayed.

When a pattern exists in the pattern No. of the specified writing destination, the overwriting confirmation screen is displayed.

When ENTER button  is pressed there, writing is started.

3-5. Pattern reading

Pattern data written to the media is read in.



Use the media which has been formatted with IP-420.

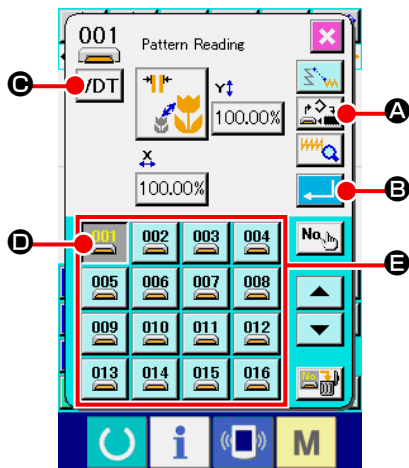



① **Display the pattern reading screen.**

Press READ button  to display the pattern reading screen.

② **Display the pattern kind selection screen.**



Press PATTERN KIND SELECTION button  (C) to display the pattern kind selection screen.

③ **Select the pattern kind.**

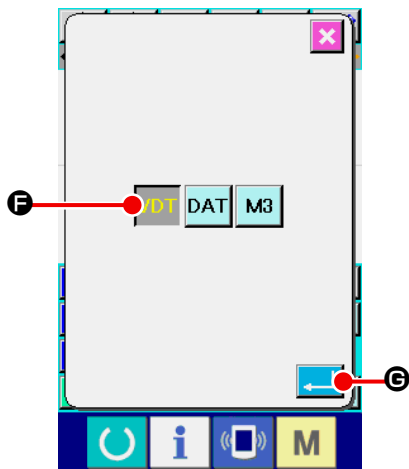

Here select VECTOR DATA  (F). The selected button is changed in color . When ENTER button  (E) is pressed, the screen returns to the pattern reading screen.



④ **Select the object media.**

Press OBJECT MEDIA SELECTION button (A) to display the object media selection screen. Select MEDIA , press ENTER button , and the screen returns to the pattern reading screen. PATTERN button  (D) of the pattern existing in the part of (E) is displayed.

⑤ **Select the pattern.**

Press PATTERN button  (D) of the pattern No. you desire to read in. The selected pattern button is changed in color .

⑥ **Read the pattern.**

When ENTER button  (E) is pressed, reading of the pattern is started. When the reading of pattern is ended, the standard screen is displayed.

4. INPUT OF PATTERN

4-1. Ordinary sewing

(1) Jump feed (020)

This is used when moving the presser to the specified position without driving the sewing machine.

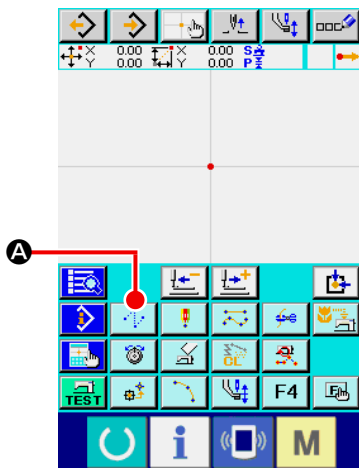

① **Display the jump feed setting screen.**

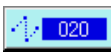
When pressing JUMP FEED button  **A** in the standard screen or selecting and executing JUMP FEED (function code 020)  in the code list screen, the jump feed setting screen is displayed.

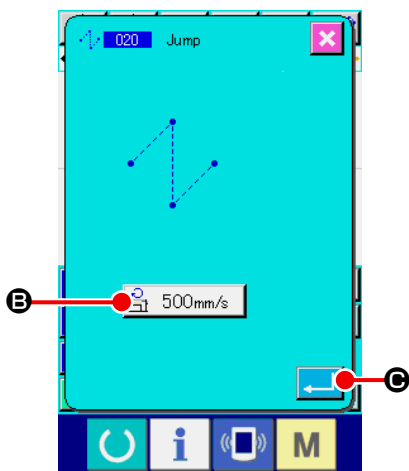

② **Set the jump feed.**

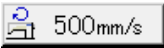
Present jump feed speed set value is displayed at JUMP FEED SPEED SETTING button  **B** in the jump feed setting screen.

When changing the jump feed speed, press the jump feed speed setting button, and the jump feed speed input screen is displayed.

After setting or when it is not necessary to change, press ENTER button  **C**, and the coordinate input screen is displayed.

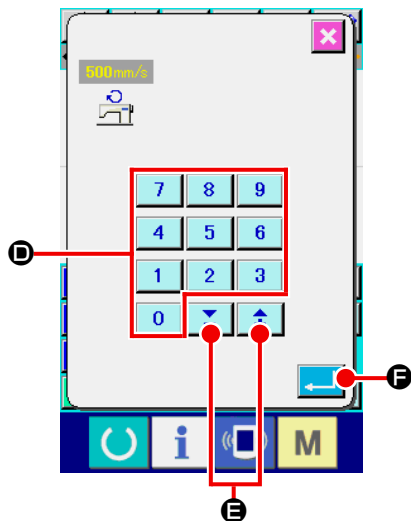

③ **Set the jump feed speed.**

Direct input the value with TEN keys **0** to **9** **D** or increase/decrease the value with + or - button **+** **-** **E** in the jump feed speed input screen, and set the jump feed speed.

When ENTER button **↩** **F** is pressed, the input value becomes effective, and the screen returns to the jump feed setting screen.

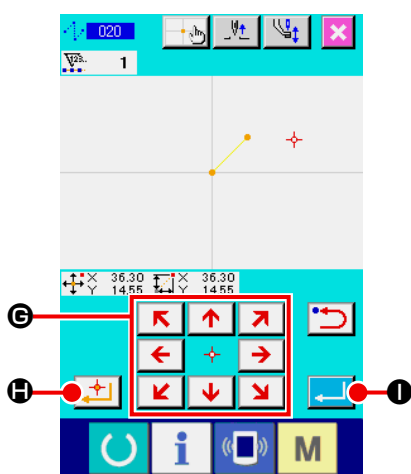

④ **Move the needle position.**

Press MOVE key

↖	↑	↗
←	+	→
↙	↓	↘

G in the coordinate input screen, and the needle position moves in the specified direction. While MOVE key is held pressed, the needle position continuously moves.

⑤ **Input the coordinate.**

When the needle position has moved to the specified position and DECIDING POINT button **⊕** **H** is pressed, the position is inputted as the shape point (passing point).

⑥ **End the setting of jump feed.**

When ENTER button **↩** **I** is pressed, the set data is inputted, and the screen returns to the standard screen.

It is possible to input by repeating the operation of steps ④ and ⑤ as well.

(2) Linear ordinary sewing (023)

When one point is specified, the straight line connecting the point and the needle position is inputted as the specified stitch length.

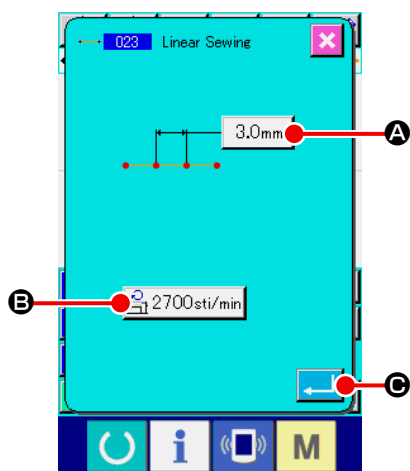

- ① **Display the linear ordinary sewing setting screen.**
 Select and execute LINEAR ORDINARY SEWING (function code 023) in the code list screen, and the linear ordinary sewing setting screen is displayed.

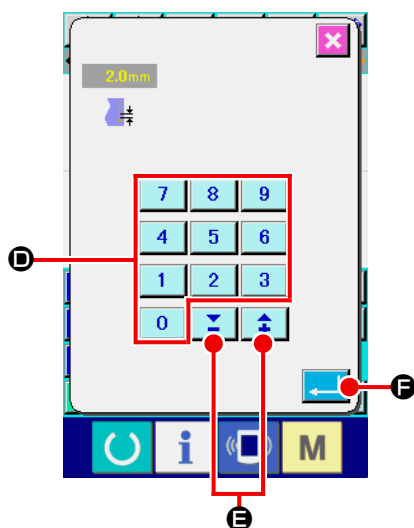

- ② **Set the linear ordinary sewing.**
 The set value of the present stitch length is displayed at STITCH LENGTH INPUT button **A** and the set value of the present sewing speed is displayed at SEWING SPEED INPUT button **B** in the linear ordinary sewing setting screen.

When the button of the item you desire to change the setting the input screen of the set value is displayed. Set the value in the input screen with TEN keys to **D**, or + or - button **E**, press ENTER button **F** and the input value is determined. Then the screen returns to the linear ordinary sewing setting screen.

After setting, or when it is not necessary to change, press ENTER button **C** in the linear ordinary sewing setting screen, and the coordinate input screen is displayed.

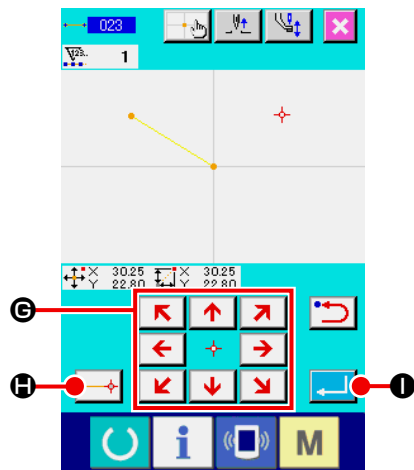

③ **Move the needle position.**

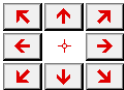
Press MOVE key  G in the coordinate input screen, and the needle position moves in the specified direction. While MOVE key is held pressed, the needle position continuously moves.

④ **Input the coordinate.**

When the needle position has moved to the specified position and DECIDING POINT button  H is pressed, the position is inputted as the shape point (passing point).

⑤ **End the setting of linear ordinary sewing.**

When ENTER button  I is pressed, the set data is inputted, and the screen returns to the standard screen.

It is possible to input by repeating the operation of steps ③ and ④ as well.

(3) Spline ordinary sewing (024)

It is possible to simply input the smooth curve using the spline ordinary sewing.

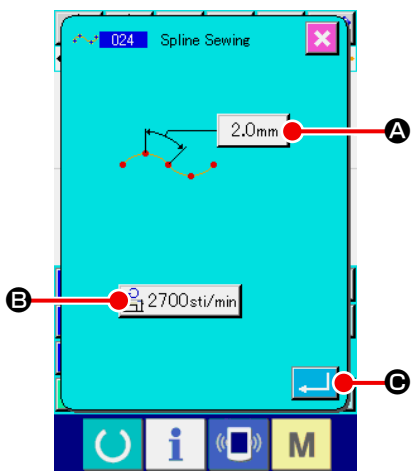

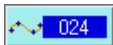
① **Display the spline ordinary sewing setting screen.**
When selecting and executing SPLINE ORDINARY SEWING (function code 024)  in the code list screen, the spline ordinary sewing setting screen is displayed.

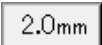
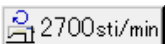
② **Set the spline ordinary sewing.**
The set value of present stitch length is displayed at STITCH LENGTH INPUT button  **A**, and the set value of present sewing speed is displayed at SEWING SPEED INPUT button  **B** in the spline ordinary setting screen.

When the button of the item you desire to change the setting is pressed, the input screen of the set value is displayed. Setting procedure of stitch length and sewing speed is the same as that of the linear ordinary sewing.

After setting or when it is not necessary to change, press ENTER button  **C**, and the coordinate input screen is displayed.

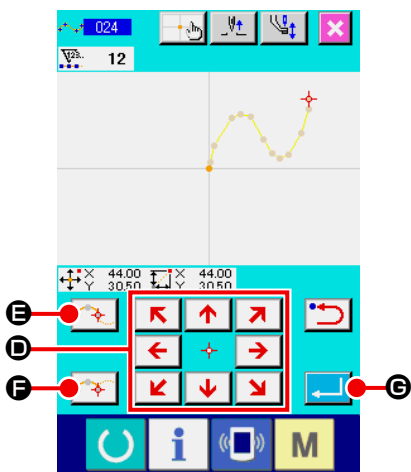

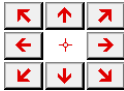
③ **Move the needle position.**
Press MOVE key  **D** in the coordinate input screen, and the needle position moves in the specified direction.

④ **Input the coordinate.**
When the needle position has moved to the specified position, press PASSING POINT button  **E**, and the position is inputted as the shape point (passing point).

Or, press DECIDING POINT button  **F**, and the position is inputted as the breakpoint.

For the breakpoint, refer to ["4-9. Breakpoint \(spline and ordinary sewing\)" p.58](#).

⑤ **End the setting of spline ordinary sewing.**
When ENTER button  **G** is pressed, the set date is inputted, and the screen returns to the standard screen. DECIDING POINT button of the last point can be omitted.

It is possible to input by repeating the operation of steps ③ and ④ as well.

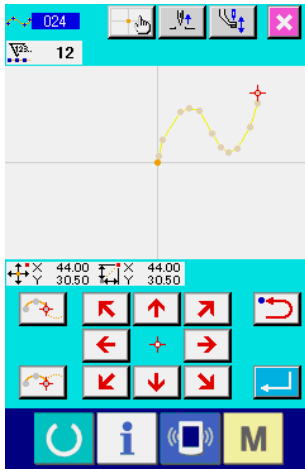

1. In order to input the smooth shape of spline ordinary sewing, the neat curve can be obtained when selecting the input point following the procedure below.

- 1) Select the top of input curve as the input point. (⑤ and ⑨)
- 2) Making the points selected in step 1) the center, select the points which are separated a little before and after the points in step 1). (④ , ⑥ , ⑧ , and ⑩)
- 3) Further, select the center of the section having loose bulge as the input points. (③ , ⑦ , and ⑪)
- 4) Select the points near both ends and the last point as the input points. (② , ⑫ , and ⑬)

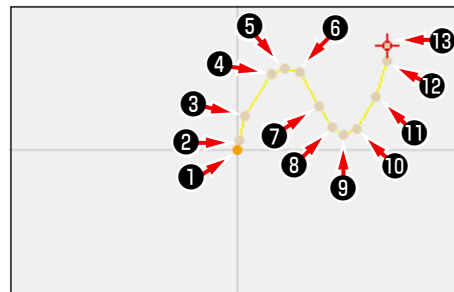

Input the input points selected by the steps above in order. Also, be careful of the points below.

- Take rather many input points at the sharp curve and rather few ones at the gentle curve.
- Take 3 input points per curve at least.

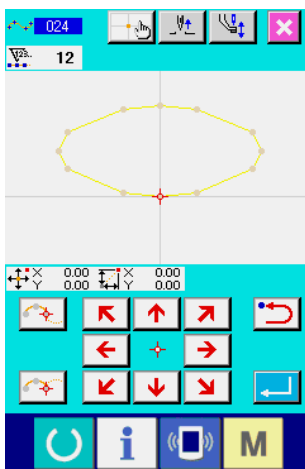

2. Ellipse can be inputted using the spline ordinary sewing.

- 1) Take the joint of the curve at the gentle section of the curve.
- 2) Take the input points so as to be symmetrical if possible.

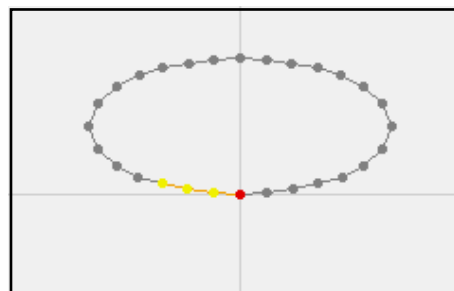

(4) Arc ordinary sewing (025)

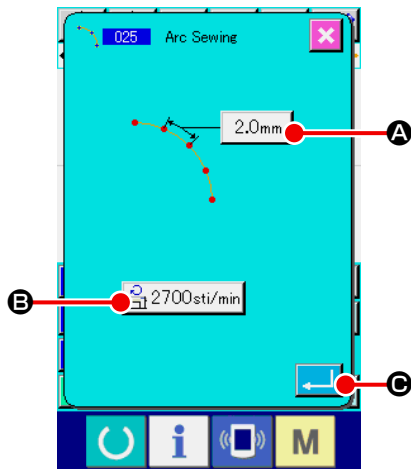

When two points are specified, the arc connecting the points and the needle position is inputted as the specified stitch length. Sewing direction is in the order of the specified points, and either clockwise direction or counterclockwise one can be inputted.



① Display the arc ordinary sewing setting screen.

When selecting and executing ARC ORDINARY SEWING (function code 025)  in the code list screen, the arc ordinary sewing setting screen is displayed.

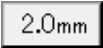
② Perform setting of the arc ordinary sewing.

The set value of present stitch length is displayed at STITCH LENGTH INPUT button  (A), and the set value of present sewing speed is displayed at SEWING SPEED INPUT button  (B) in the arc ordinary sewing setting screen.

When the button of the item you desire to change is pressed, the input screen of the set value is displayed. Setting procedure of stitch length and sewing speed is the same as that of the linear ordinary sewing.

After setting or when it is not necessary to change, press ENTER button  (C), and the coordinate input screen is displayed.

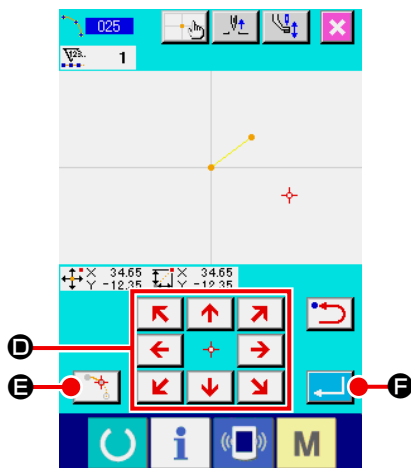

③ Move the needle position.

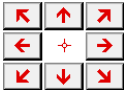
Press MOVE key  (D) in the coordinate input screen, and the needle position moves in the specified direction.

④ Input the coordinate.

When the needle has moved to the specified position, press DECIDING POINT button  (E), and the position is inputted as the shape point (passing point).

Repeat the operation of the steps of ③ and ④ to input two points. Two input points are necessary as the number of input points. Also, it is not possible to input more than 3 points.

⑤ End setting of the arc ordinary sewing.

When ENTER button  (F) is pressed, the set data is inputted, and the screen returns to the standard screen. DECIDING POINT button of the last point can be omitted.

(5) Circle ordinary sewing (026)

When two points are specified, the circle connecting the points and the needle position is inputted as the stitch length. Stitch direction is in the order of the specified points, and either clockwise direction or counterclockwise one can be inputted.

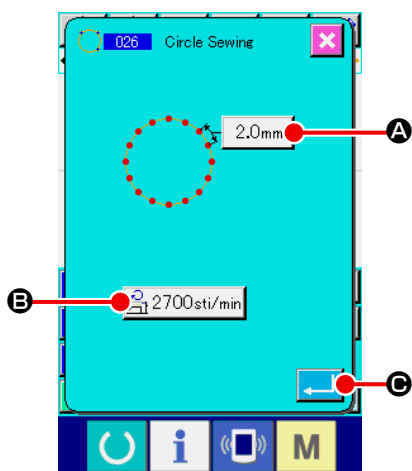

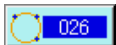
① **Display the circle ordinary sewing setting screen.**
When selecting and executing CIRCLE ORDINARY SEWING (function code 026)  in the code list screen, the circle ordinary sewing setting screen is displayed.

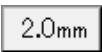
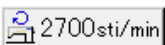
② **Perform setting of the circle ordinary sewing.**
The set value of present stitch length is displayed at STITCH LENGTH INPUT button  **A**, and the set value of present sewing speed is displayed at SEWING SPEED INPUT button  **B** in the circle ordinary sewing setting screen.

When the button of the item you desire to change is pressed, the input screen of the set value is displayed. Setting procedure of stitch length and sewing speed is the same as that of the linear ordinary sewing.

After setting, or when it is not necessary to change, press ENTER button  **C**, and the coordinate input screen is displayed.

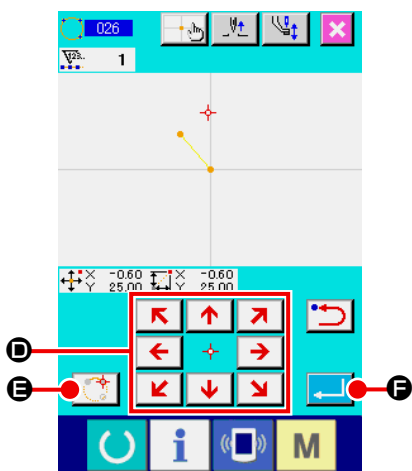

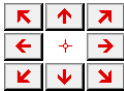
③ **Move the needle position.**
Press MOVE key  **D** in the coordinate input screen, and the needle position moves in the specified direction.

④ **Input the position.**
When the needle position has moved to the specified position, press DECIDING POINT button  **E**, and the position is inputted as the shape point.

Repeat the operation of the steps of ③ and ④ to input two points. Two input points are necessary as the number of input points. Also, it is not possible to input more than 3 points.

⑤ **End setting of the circle ordinary sewing.**
When ENTER button  **F** is pressed, the set data is inputted, and the screen returns to the standard screen. DECIDING POINT button of the last point can be omitted.

(6) Point sewing (021)

This function is used when direct inputting the needle entry point one stitch by one stitch.

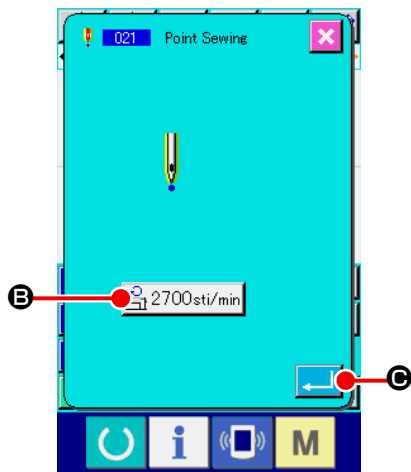

① Display the point sewing setting screen.

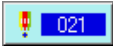
Press POINT SEWING button  in the standard screen, or select and execute POINT SEWING (function code 021)  in the code list screen, the point sewing setting screen is displayed.

② Perform setting of the point sewing.

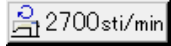
The set value of present sewing speed is displayed at SEWING PEED INPUT button  **B** in the point sewing setting screen.

When SEWING SPEED INPUT button is pressed, the sewing speed input screen is displayed. Setting procedure of the sewing speed is the same as that of the linear ordinary sewing.

After setting, or when it is not necessary to change, press ENTER button  **C**, and the coordinate input screen is displayed.

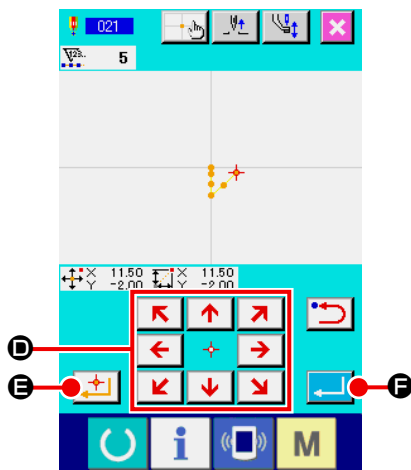

③ Move the needle position.

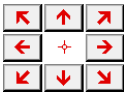
Press MOVE key  **D** in the coordinate input screen, and the needle position moves in the specified direction.

④ Input the coordinate.

When the needle position has moved to the specified position, press DECIDING POINT button  **E**, and the position is inputted as the shape point.

It is possible to input by repeating the operation of steps ③ and ④ as well.

⑤ End setting of the point sewing.

When ENTER button  **F** is pressed, the set data is inputted, and the screen returns to the standard screen. DECIDING POINT button of the last point can be omitted.

(7) Ordinary sewing (022)

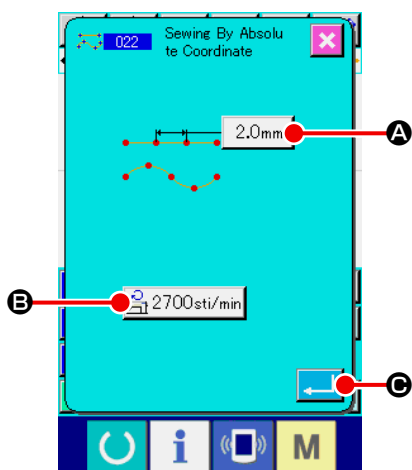

This function can input the linear ordinary sewing and the spline ordinary sewing.

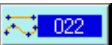

① Display the ordinary sewing setting screen.

Press ORDINARY SEWING button  in the standard screen, or select and execute ORDINARY SEWING (function code 022)  in the code list screen, and the ordinary sewing setting screen is displayed.

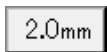
② Perform setting of the ordinary sewing.



The stitch length can be set with STITCH LENGTH INPUT button  **A**, and the sewing speed can be set with SEWING SPEED INPUT button  **B** in the ordinary sewing setting screen.

When the button of the item you desire to change is pressed, the input screen of the set value is displayed. Setting procedure of the stitch length and the sewing speed is the same as that of the linear ordinary sewing.

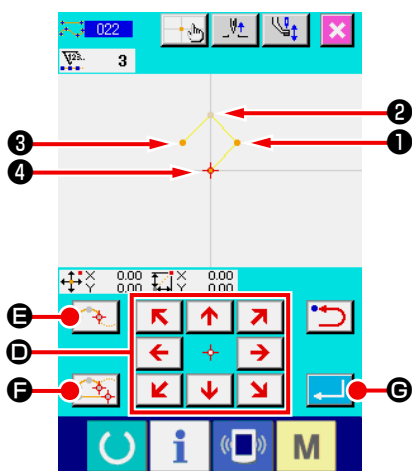
When ENTER button  **C** is pressed, the coordinate input screen is displayed.

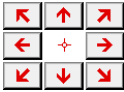

③ Specify the position.

Press MOVE key  **D** in the coordinate input screen, and the needle position moves in the specified direction. When DECIDING POINT button  **F** is pressed, the shape point of the linear ordinary sewing is inputted. When PASSING POINT button  **E** is pressed, the shape point of the spline ordinary sewing is inputted.

(Refer to "4-9. Breakpoint (spline and ordinary sewing)" p.58.)

④ End setting of the ordinary sewing.

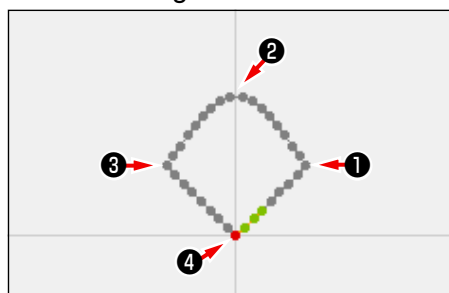

When ENTER button  **G** is pressed, the set data is inputted, and the screen returns to the standard screen. For example, when **1**, **3** and **4** are inputted with DECIDING POINT button, and **2** is inputted with PASSING POINT button, a pattern as shown in the figure below is created.



4-2. Zigzag sewing (030 to 033)

This function is the input function to create the needle entry point of zigzag in the lateral direction in terms of the input reference line. It is convenient to perform inputting of zigzag sewing of wappen or the like.

There are 4 kinds of zigzag sewings below.

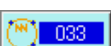
- Linear zigzag sewing (function code 030) 
- Spline zigzag sewing (function code 031) 
- Arc zigzag sewing (function code 032) 
- Circle zigzag sewing (function code 033) 

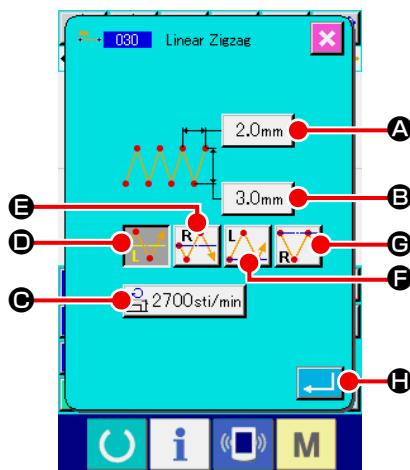
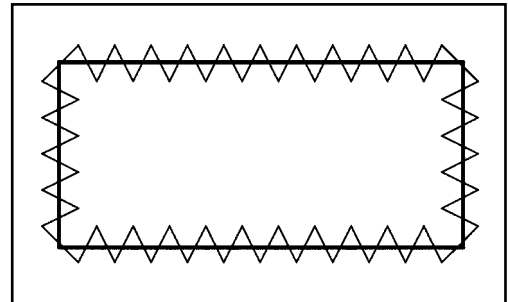

① Display the linear zigzag sewing setting screen.

When LINEAR ZIGZAG SEWING (function code 030)

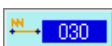
 is selected and executed in the code list screen, the linear zigzag sewing setting screen is displayed.

② Perform setting of the linear zigzag sewing.

The set value of present zigzag pitch is displayed at ZIGZAG

PITCH INPUT button  (A), the set value of present zigzag width is displayed at ZIGZAG WIDTH INPUT button

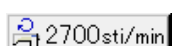
 (B), and the set value of present sewing speed is displayed at SEWING SPEED INPUT button  (C)



in the linear zigzag sewing setting screen.

When the button of the item you desire to change is pressed, the input screen of the set value is displayed. Setting procedure in the input screen of each item is the same as that of the linear ordinary sewing.

When the button for the item setting of which is to be changed is pressed, the corresponding set value input screen is displayed. The procedure for inputting a set value on the corresponding item input screen is similar to that for the linear ordinary sewing.

The position and direction to start zigzag sewing can be

selected using START DIRECTION button  (D),  (E),

 (F) or  (G). The button which is displayed in reverse video represents the currently selected position and direction to start zigzag sewing.

After setting, or when it is not necessary to change, press ENTER button  (H), and the coordinate input screen is displayed.

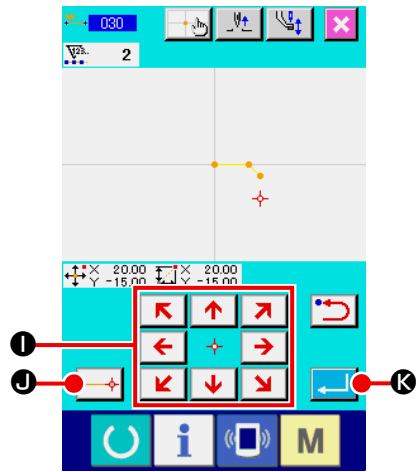

③ **Move the needle position.**

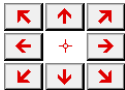
When MOVE key  ① in the coordinate input screen is pressed, the needle position moves in the specified direction.

④ **Input the coordinate.**

When the needle position has moved to the specified position and DECIDING POINT button  ② is pressed, the position is inputted as the shape point (passing point).

It is possible to input by repeating the steps of ③ and ④ as well.

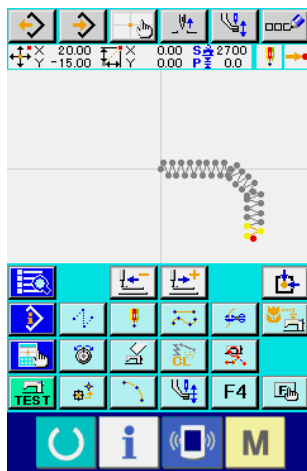







⑤ **End setting of the linear zigzag sewing.**

When ENTER button  ③ is pressed, the set data is inputted, and the screen returns to the standard screen. DECIDING POINT button of the last point can be omitted.

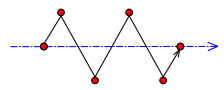
Setting procedure of the zigzag sewing of other shapes is the same as that of the linear zigzag sewing.

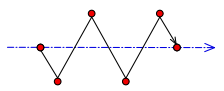
Coordinate inputting procedure of the respective sewings is the same as that of the ordinary sewing.

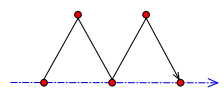

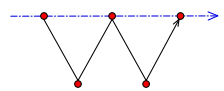
Zigzag sewing starting method list

No.	Button	Type of direction to start sewing	Description	Example
1		Leftward of the center of stitch base line	Sewing is started from the left side toward the direction of travel with the stitch base line set at the center of zigzag width. Stitches are produced in the zigzag form.	
2		Rightward of the center of stitch base line	Sewing is started from the right side toward the direction of travel with the stitch base line set at the center of zigzag width. Stitches are produced in the zigzag form.	
3		Leftward of the end of stitch base line	Sewing is started from the left side with the stitch base line set at the right end of zigzag width toward the direction of travel.	
4		Rightward of the end of stitch base line	Sewing is started from the right side with the stitch base line set at the left end of zigzag width toward the direction of travel.	

4-3. Offset sewing (034 to 037)

This is an input function to create the needle entry point which is separated an optional fixed distance in terms of the input reference line. It is convenient when inputting the needle entry point taking the periphery of small thing as the reference when attaching the small things or the like.

There are 4 kinds of the offset sewings below.

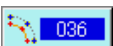
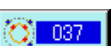

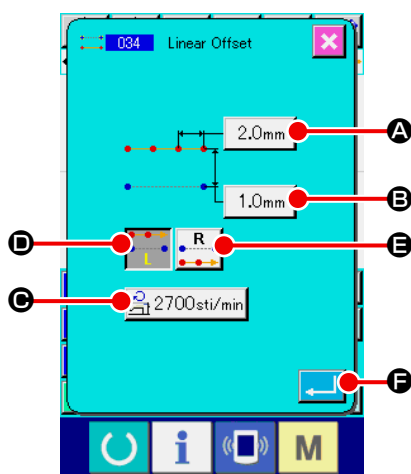
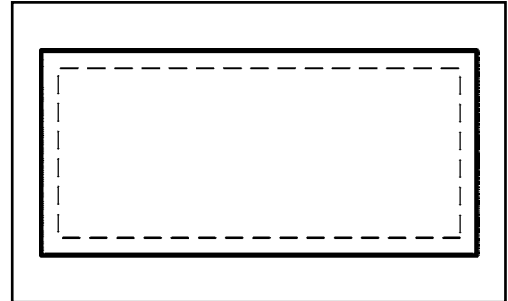
- Linear offset sewing (function code 034) 
- Spline offset sewing (function code 035) 
- Arc offset sewing (function code 036) 
- Circle offset sewing (function code 037) 

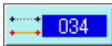

① **Display the linear offset sewing setting screen.**



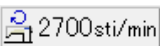

When selecting and executing LINEAR OFFSET SEWING (function code 034)  in the code list screen, the linear offset sewing setting screen is displayed.



② **Perform setting of the linear offset sewing.**

The set value of present stitch length is displayed at STITCH LENGTH INPUT button  (A), the set value of present offset width is displayed at OFFSET WIDTH INPUT button , and the set value of present sewing speed is displayed at SEWING SPEED INPUT button  (C) in the linear offset sewing screen.

When the button of the item you desire to change is pressed, the set value is displayed in the input screen. Setting procedure of the respective items in the input screen is the same as that of the linear ordinary sewing.

Creation direction of the offset sewing can be specified with

CREATION DIRECTION buttons  (D) and  (E). Button  or  which is changed in color is the creation direction which is selected now.

When CREATION DIRECTION, LEFT button  (D) is pressed, the offset sewing is created on the left side in terms of the progressing direction and when CREATION DIRECTION, RIGHT button  (E) is pressed, the offset sewing is created on the right side in terms of the progressing direction.

After setting, or when it is not necessary to change, press ENTER button  (F), and the coordinate input screen is displayed.

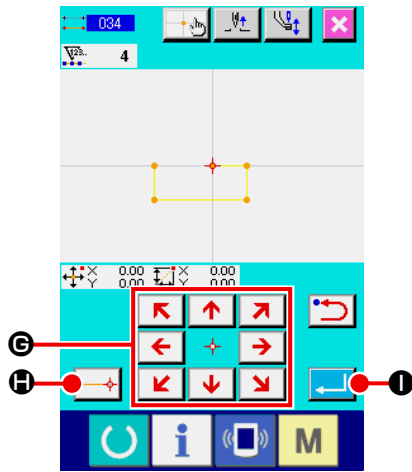

③ **Move the needle position.**

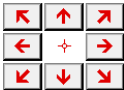
Press MOVE key  ⑥ in the coordinate input screen, and the needle position moves in the specified direction.

④ **Input the coordinate.**

When the needle position has move to the specified position, press DECIDING POINT button  ⑦, and the position is inputted as the shape point (passing point).

It is possible to input by repeating the steps of ③ and ④ as well.

⑤ **End setting of the linear offset sewing.**

When ENTER button  ⑧ is pressed, the set data is inputted, and the screen returns to the standard screen.

DECIDING POINT button of the last point can be omitted.

Setting procedure of the offset sewing of other shapes is the same as that of the linear offset sewing.

Inputting procedure of the coordinate of the respective sewings is the same as that of the ordinary sewing.

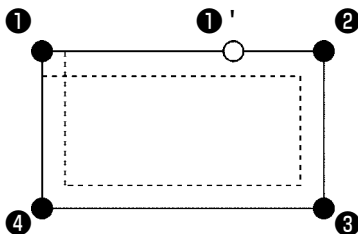



1. Start the shape as shown in the left-hand figure from the position of ①, and input in the order of ②→③→④→①. Then the pattern as shown in the broken line is created. When starting not the corner of polygon as ① but starting from the side as ①', a neat offset sewing can be created.
2. Input a shape that one line is formed from the start point to the end point of input.
3. In case of arc or circle, when the width is made larger than the radius of circle, the pattern which is against expectation is created. So, be careful.

4-4. Double sewing

This is an input function to create the needle entry point to the point which is separated an optional fixed distance in terms of the input reference line.

(1) Double orderly sewing (040 to 043)

Create the sewing so that the sewing composed with the input points and that of the offset figure are in the same direction. There are 4 kinds of double orderly sewings below.

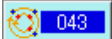
- Linear double orderly sewing (function code 040) 
- Spline double orderly sewing (function code 041) 
- Arc double orderly sewing (function code 042) 
- Circle double orderly sewing (function code 043) 

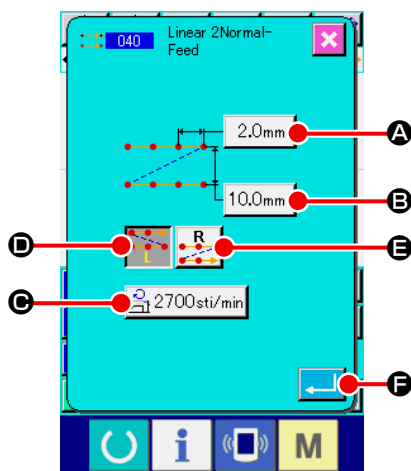
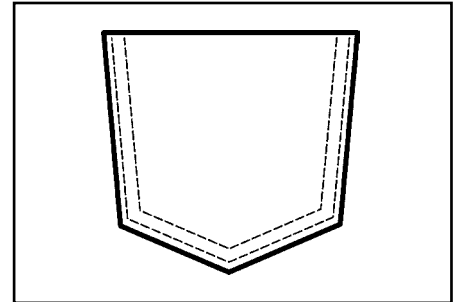



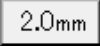
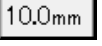
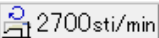

① **Display the linear double orderly sewing setting screen.**
When selecting and executing LINEAR DOUBLE ORDERLY SEWING (function code 040)  in the code list screen, the linear double orderly sewing setting screen is displayed.

② **Perform setting of the linear double orderly sewing.**
The set value of present stitch length is displayed at STITCH LENGTH INPUT button  (A), the set value of present double sewing width is displayed at DOUBLE SEWING WIDTH INPUT button  (B), and the set value of present sewing speed is displayed at SEWING SPEED INPUT button  (C) in the linear double orderly sewing setting screen.

When the button of the item you desire to change is pressed, the input screen of the set value is displayed. Setting procedure in the input screen of the respective items is the same as that of the linear ordinary sewing.

Creating direction of the double sewing can be specified

with CREATING DIRECTION buttons  (D) and  (E).

Button  or  which is changed in color is the creating direction which is selected now. When CREATION

DIRECTION, LEFT button  (D) is pressed, the double

sewing is created on the left-hand side in terms of the progressing direction, and CREATING DIRECTION, RIGHT

 (E) is pressed, the double figure is created on the right-

hand side in terms of the progressing direction.

After setting, or when it is not necessary to change, press ENTER

button  (F), and the coordinate input screen is displayed.

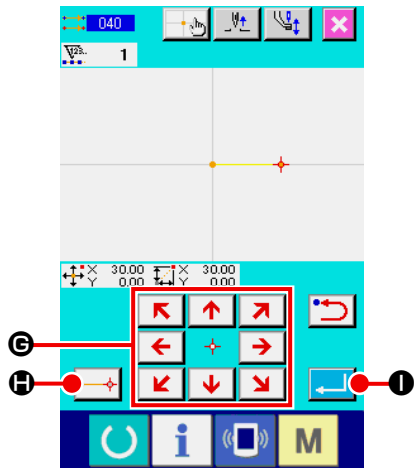

③ **Move the needle position.**

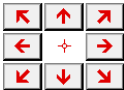
Press MOVE key  **G** in the coordinate screen, and the needle position moves in the specified direction.

④ **Input the coordinate.**

When the needle position has moved to the specified position and DECIDING POINT button  **H** is pressed, the position is inputted as the shape point (passing point).

It is possible to input by repeating the steps of ③ and ④ as well.

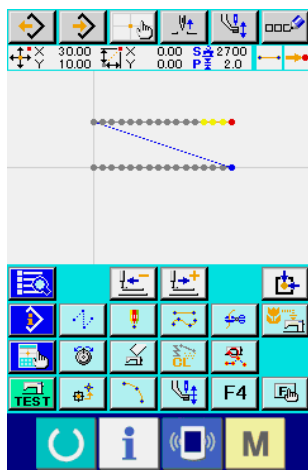

⑤ **End setting of the linear double orderly sewing.**

When ENTER button  **I** is pressed, the set data is inputted, and the screen returns to the standard screen. DECIDING POINT button of the last point can be omitted.

Setting procedure of the double orderly sewings of other shapes is the same as that of the linear double orderly sewing. Coordinate inputting procedure of the respective sewings is the same as that of the ordinary sewing.





In case of arc or circle, when the width is made larger than the radius of circle, the pattern which is against expectation is created. So, be careful.

(2) Double reverse sewing (044 to 047)

Create the sewing so that the sewing composed at the input point and that of the offset figure are in the reverse direction.

There are 4 kinds of the double reverse sewings below.

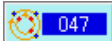
- Linear double reverse sewing (function code 044) 
- Spline double reverse sewing (function code 045) 
- Arc double reverse sewing (function code 046) 
- Circle double reverse sewing (function code 047) 

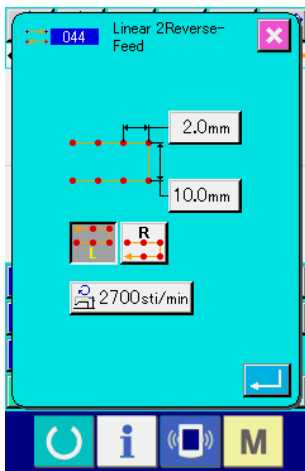
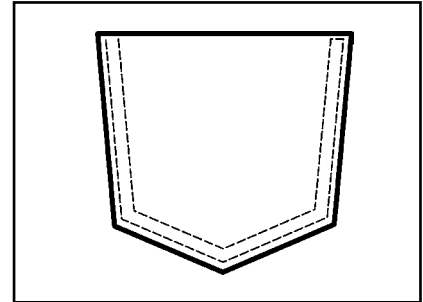

① Display the linear double reverse sewing setting screen.

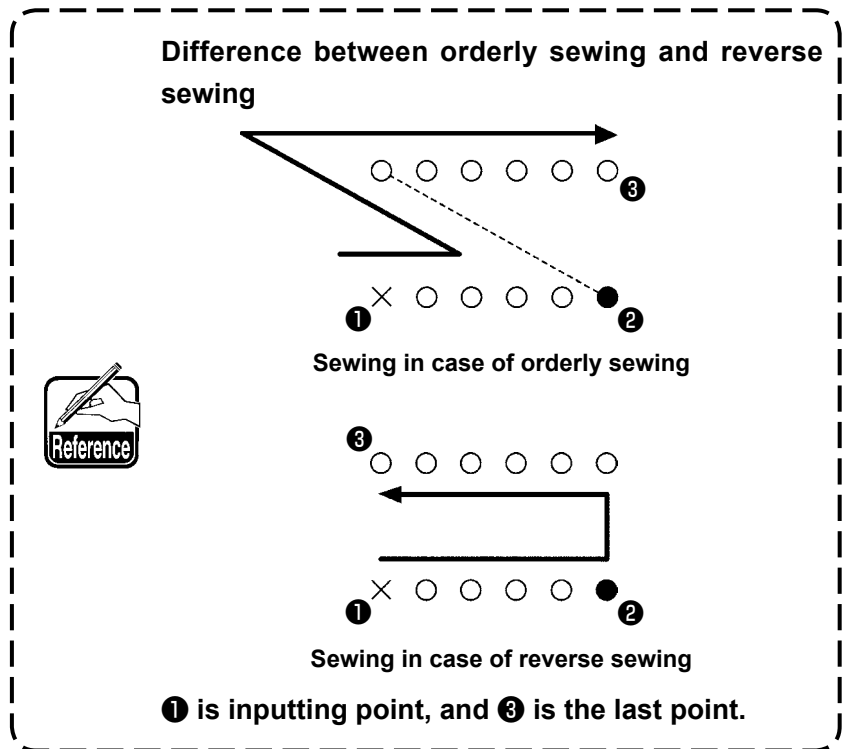

When selecting and executing LINEAR DOUBLE REVERSE SEWING (function code 044)  in the code list screen, the linear double reverse sewing setting screen is displayed. Setting procedure of the double reverse sewing is the same as that of the double orderly sewing.



Caution In case of arc or circle, when the width is made larger than the radius of circle, the pattern which is against expectation is created. So, be careful.

(3) Overlapped reverse sewing (050 to 053)

Sewing of the figure composed at the input point and that which returns it reversely are created. There are four different types of overlapped reverse sewing as described below:

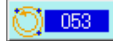
- Linear overlapped reverse sewing (function code 050) 
- Spline overlapped reverse sewing (function code 051) 
- Arc overlapped reverse sewing (function code 052) 
- Circle overlapped reverse sewing (function code 053) 

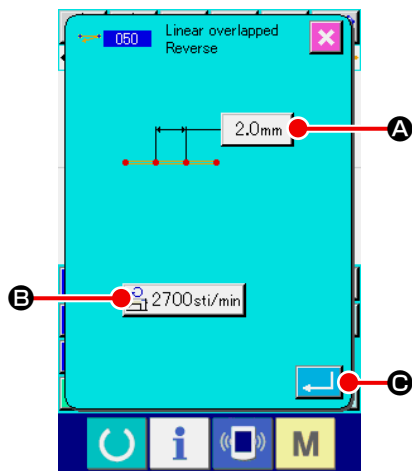

① Displaying the linear overlapped reverse sewing setting screen

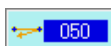
When selecting and executing LINEAR OVERLAPPED REVERSE SEWING (function code 050)  on the code list screen, the linear overlapped reverse sewing setting screen is displayed.

② Performing setting of the linear overlapped reverse sewing

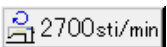
On the linear overlapped reverse sewing setting screen, the current set value of stitch length is indicated on STITCH LENGTH INPUT button  **A** and the current set value of speed of stitch is indicated on SPEED OF STITCH INPUT button  **B**.

When the button of the item you desire to change is pressed, the input screen of the set value is displayed. Setting procedure of stitch length and sewing speed is the same as that of the linear ordinary sewing.

After setting, or when it is not necessary to change, press ENTER button  **C**, and the coordinate input screen is displayed.

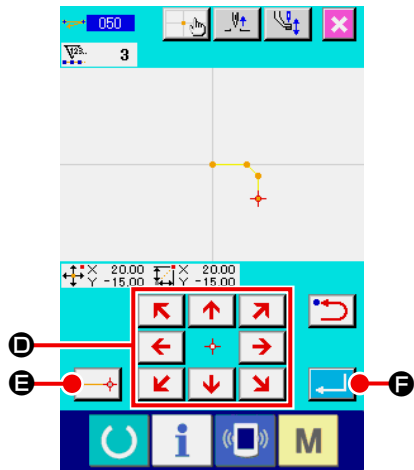

③ **Move the needle position.**

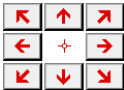
Press MOVE key  (D) in the coordinate input screen, and the needle position moves in the specified direction.

④ **Input the coordinate.**

When the needle position has moved to the specified position, and DECIDING POINT button  (E) is pressed, the position is inputted as the shape point (passing point).

It is possible to input by repeating the steps of ③ and ④ as well.



⑤ **End setting of the linear reverse sewing.**

When ENTER button  (F) is pressed, the set data is inputted, and the screen returns to the standard screen. DECIDING POINT button of the last point can be omitted.

Setting procedure of the reverse sewings of other shapes is the same as that of the linear reverse sewing.

4-5. Machine control command

Machine control command inputs various control commands to the present point.

(1) Thread trimming (001)

Thread trimming can be optionally performed on the way of pattern data.

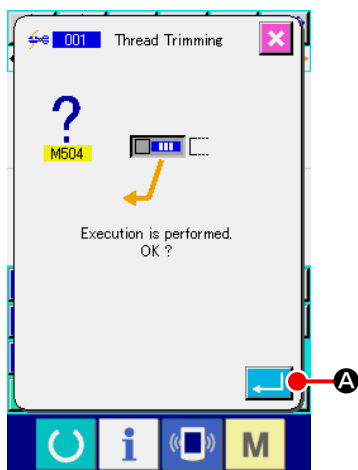

① **Select thread trimming.**

When selecting and executing THREAD TRIMMING (function code 001)  in the code list screen, the left-hand screen is displayed.

② **Input thread trimming.**

When ENTER button  **A** is pressed in the left-hand screen, thread trimming is inputted, and the screen returns to the standard screen.

(2) The 2nd origin (002)

This function can set the 2nd origin between the origin and the sewing start point, and specify the needle position before the start of sewing motion. 2nd origin can be set only on the way of jump feed.

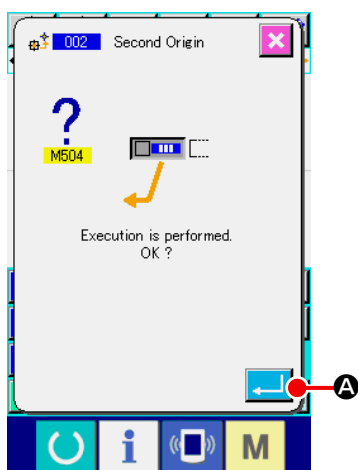

① **Set the present needle position to one point on the pattern of jump feed.**

② **Select the 2nd origin.**

When selecting and executing 2ND ORIGIN (function code 002)  in the code list screen, the left-hand screen is displayed.

③ **Input the 2nd origin.**

When ENTER button  **A** is pressed in the right-hand screen, the 2nd origin is inputted, and the screen returns to the standard screen.

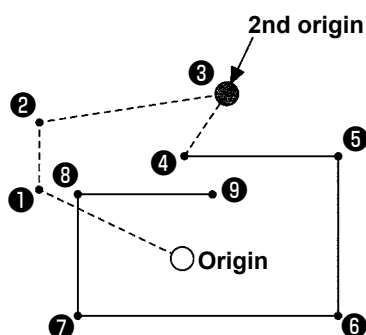

When 2nd origin is set at ③ of the jump feed section in the left-hand figure, the feed stops at ③ after jump feed of ① → ② → ③, then the sewing machine performs the cycle operation of ③ through ⑨.



This function has to set the present needle position to one point on the pattern of jump feed beforehand. When enlarging or reducing the pattern, the route from the origin to the 2nd origin is not enlarged or reduced.

(3) Stop (003)

This function inputs the Stop command.

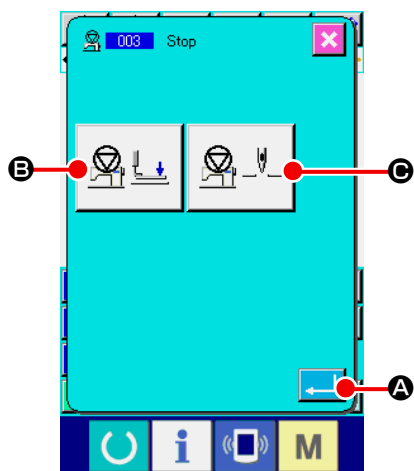

① Select the Stop.

When selecting and executing STOP (function code 003)

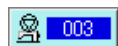
 in the code list screen, the left-hand screen is displayed.

② Specify the stop state.

The presser state at the time of stop is displayed at PRESSER

STATE SETTING button  **B**, and the needle position

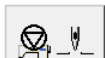
at the time of stop is displayed at NEEDLE POSITION SETTING button  **C**.

To specify the state, press the buttons of PRESSERSTATE

SETTING button  **B** and of NEEDLE POSITION

SETTING button  **C**, and display the setting screen.

③ Input the Stop.

When ENTER button  **A** is pressed in the left-hand screen, the stop is inputted with the set contents, and the screen returns to the standard screen.



When performing stop after thread trimming, input in the order of thread trimming and stop.

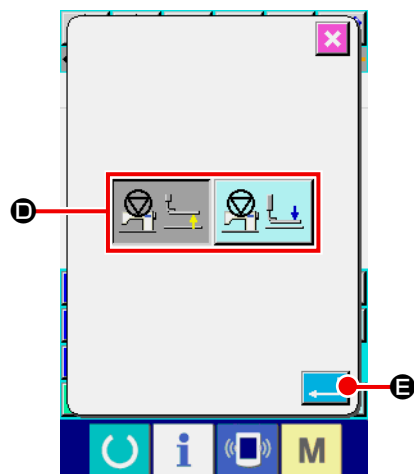



④ Perform setting of the presser state.

When PRESSER STATE SETTING button  **B** is pressed, the presser state setting screen is displayed.

The presser position at the time of stop can be selected from **D**.



The selected button is changed in color. When ENTER button

 **E** is pressed, the selected contents are inputted, and the screen returns to the stop setting screen.

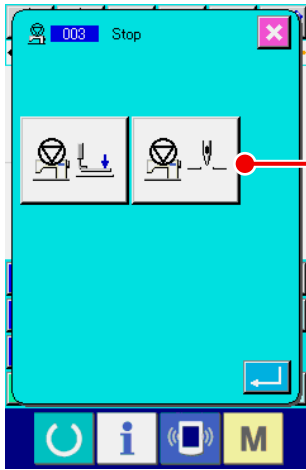

Button display	Stop position
	Presser lifting position
	Presser lowering position

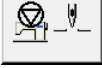

⑤ **Perform setting of the needle position.**

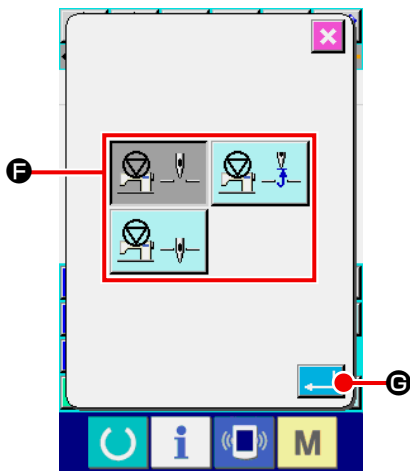
When NEEDLE POSITION SETTING button  **C** is pressed, the needle position setting screen is displayed. The needle position at the time of stop can be selected from **F**. The selected button is changed in color. When ENTER button  **E** is pressed, the selected contents are inputted, and the screen returns to the stop screen.



Button display	Stop position
	Upper dead point
	UP position
	DOWN position

 **UP position error will be produced at the time of sewing when the needle position is set to DOWN position at the end of sewing or before jump feed. Needle stop instructions become invalid when the sewing machine is in the stop state, and the needle position does not change.**

(4) One revolution of sewing machine (006)

This function inputs one revolution of sewing machine command.

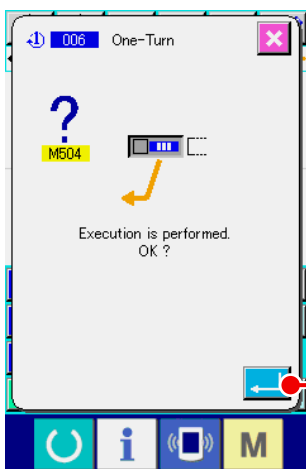

① **Select one revolution of sewing machine.**

When selecting and executing ONE REVOLUTION OF SEWING MACHINE (function code 006)  in the code list screen, the left-hand screen is displayed.

② **Input one revolution of sewing machine.**

When ENTER button  **A** is pressed in the left-hand screen, one revolution of sewing machine is inputted, and the screen returns to the standard screen.

 **This function, combined with jump feed, is used for basting or the like.**

(5) Mark 1 and mark 2 (008, 009)

These functions put marks in the pattern.

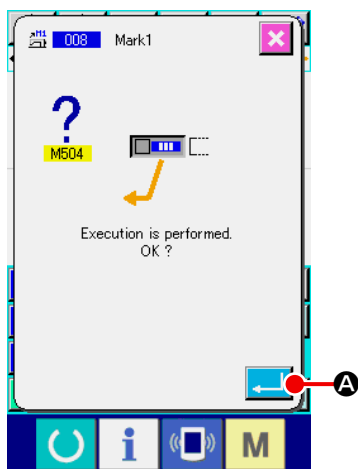

① **Select mark 1 and mark 2.**

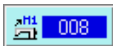
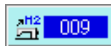
When selecting and executing MARK 1 (function code 008)  and MARK 2 (function code 009)  in the code list screen, the left-hand screen is displayed.

② **Input the mark 1.**

When ENTER button  **A** is pressed in the left-hand screen, the mark 1 is inputted, and the screen returns to the standard screen.



For the operation of the sewing machine in terms of mark 1 and mark 2, refer to the Engineer's Manual.

(6) Thread tension controller No. 3 (007)

This function inputs the thread tension controller No. 3 command.

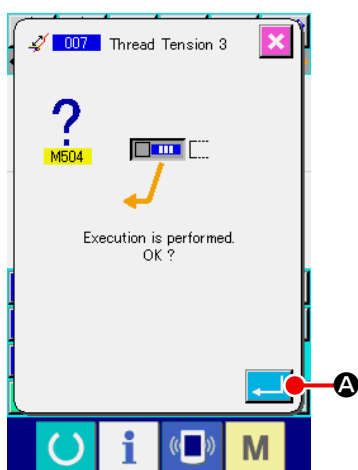

① **Select the thread tension controller No. 3.**

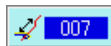
When selecting and executing THREAD TENSION CONTROLLER NO. 3 (function code 007)  in the code list screen, the left-hand screen is displayed.

② **Input the thread tension controller No. 3.**

When ENTER button  **A** is pressed in the left-hand screen, the thread tension controller No. 3 is inputted, and the screen returns to the standard screen.

(7) Delay (010)



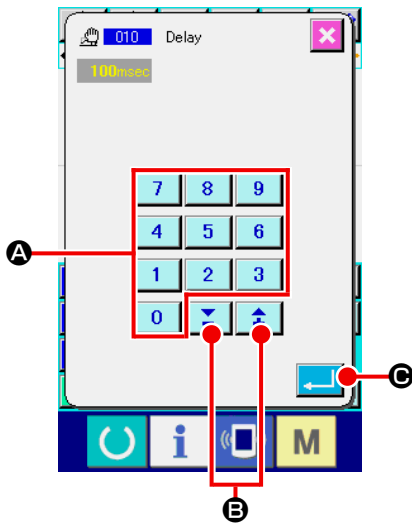

This function can set the external output time or the like.

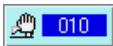

① Select the delay.

When selecting and executing DELAY (function code 010)  in the code list screen, the left-hand screen is displayed.

② Input the delay value.

When the delay value is set with TEN key  to  **A** and + or - button  **B** in the left-hand screen, and ENTER button  **C** is pressed, the delay is inputted with the set value, and the screen returns to the standard screen.



For the operation of the sewing machine in case of setting, refer to the Engineer's Manual.

(8) External input (011)



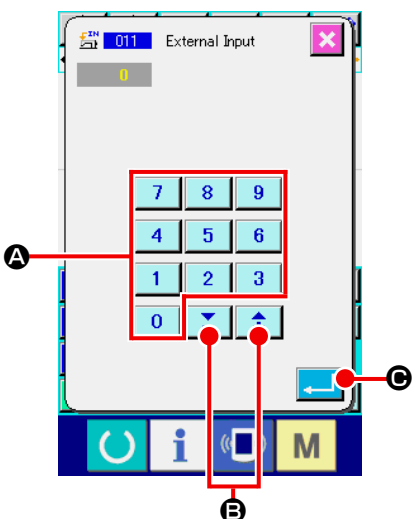

This function performs waiting for signal from input terminal of the sewing machine main unit.

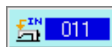

① Select the external input.

When selecting and executing EXTERNAL INPUT (function code 011)  in the code list screen, the left-hand screen is displayed.

② Perform setting of the input terminal No.

Set the terminal No. to which input is performed with TEN key  to  **A** and + or - button  **B** in the left-hand screen, and press ENTER button  **C**. Then external input is inputted, and the screen returns to the standard screen.





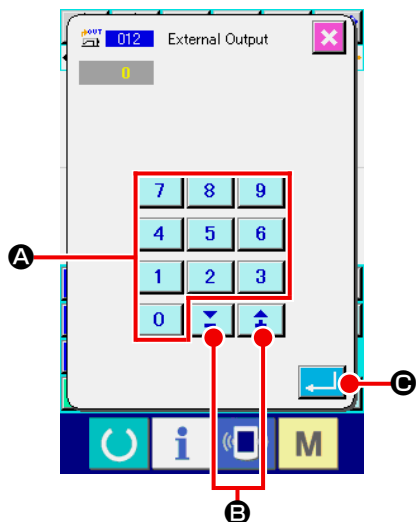

For the terminal No. and the operation of the sewing machine, refer to the Engineer's Manual.

(9) External output (012)

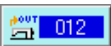
This function can send signal to the external terminal of the sewing machine main unit.



- ① **Select the external output.**
When selecting and executing EXTERNAL OUTPUT (function code 012)  in the code list screen, the left-hand screen is displayed.
- ② **Perform setting of the output terminal No.**
Set the terminal No. to which output is performed with TEN key  to  **A** and + or - button  **B** in the left-hand screen, and press ENTER button  **C**. Then external output is inputted, and the screen returns to the standard screen.





For the terminal No. and the operation of the sewing machine, refer to the Engineer's Manual.

(10) Enlargement/reduction reference point (004)

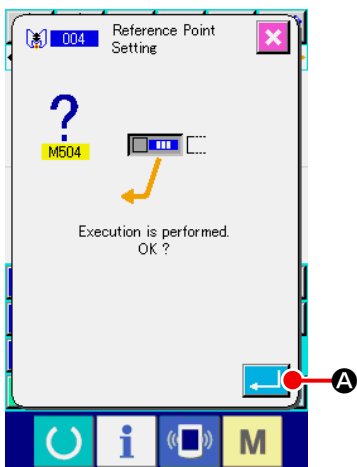
Enlargement/reduction reference point can be inputted at the optional position of the created pattern data. When the enlargement/reduction reference point is not set, taking the origin as the reference, enlargement/reduction is performed.



- ① **Select the enlargement/reduction reference point.**
When selecting and executing ENLARGEMENT/REDUCTION REFERENCE POINT (function code 004)  in the code list screen, the left-hand screen is displayed.
- ② **Perform setting of the enlargement/reduction reference point.**
When ENTER button  **A** is pressed in the left-hand screen, the enlargement/reduction reference point is inputted, and the screen returns to the standard screen.

- 
 1. When enlargement/reduction reference points are inputted more than two times, the last inputting is effective.
 2. When executing this function, set the present needle position to the position of the reference beforehand.

- 

When enlarging /reducing at the time of the pattern reading, the enlargement/reduction is performed taking the enlargement/reduction reference point as the reference. Also, similarly at the time of sewing, the enlargement/reduction is performed taking the enlargement/reduction reference point as the reference.

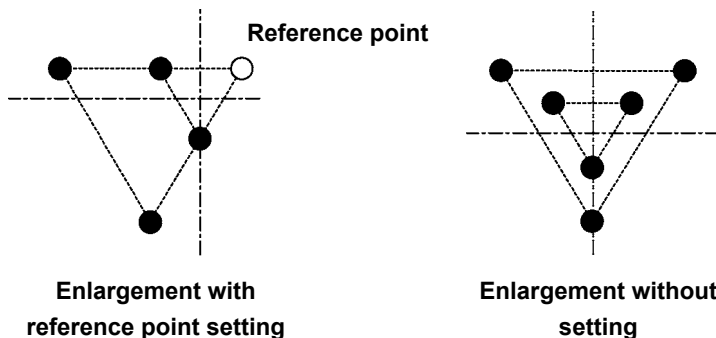

(11) Inversion point (005)

Inversion point can be inputted only when the inversion state is set to the optional inversion at clamp inversion setting ("9-2. Clamp inversion setting (091)" p.96).

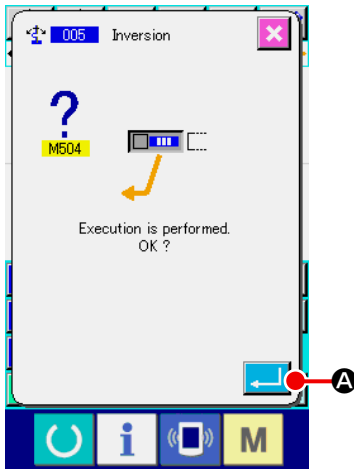

① Select the inversion point.

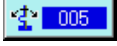
When selecting and executing INVERSION POINT (function code 005)  in the code list screen, the left-hand screen is displayed.

② Perform setting of the inversion point.

When ENTER button  **A** is pressed in the right-hand screen, the inversion point is inputted to the present needle position, and the screen returns to the standard screen.

When inversion point is inputted to the position of **5** as shown in the below figure, the linear sewing operation is performed in the order of **3** → **4** → **5** (inversion) → **6** → **7** → **3** after jump feed from the origin to **3**.

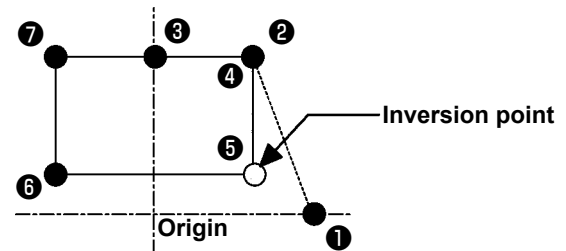



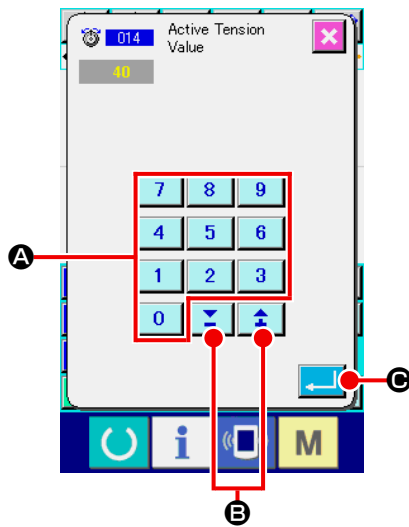

1. Inversion clamp is in the state of left-hand at the start of sewing, and repeats left-hand state and right-hand state alternately at each time of inversion command. Accordingly it is necessary to surely input the inversion command with odd numbers, In case of even numbers, the clamp and needle interfere with each other at the end of sewing, and needle may break.
2. It is not possible to set the inversion point at the positions below.
 - (a) Immediately after the 2nd origin
 - (b) Immediately after thread trimming

(12) Thread tension setting (014)

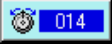
The value of the thread tension is set. This value is valid up to the place where there is the next thread tension setting command.



① **Select the thread tension setting.**
When selecting and executing THREAD TENSION SETTING (function code 014)  in the code list screen, the left-hand screen is displayed.

② **Set the value of thread tension.**
Set the value of thread tension with TEN key  to 
A, and + or - button  **B** in the left-hand screen and press ENTER button  **C**. Then the value of the set thread tension is inputted, and the screen returns to the standard screen.

The value which is really inputted as the command is :
Thread tension setting (No. 014) = Thread tension reference value (No. 113) + value to be inputted to the data (increase/decrease value)





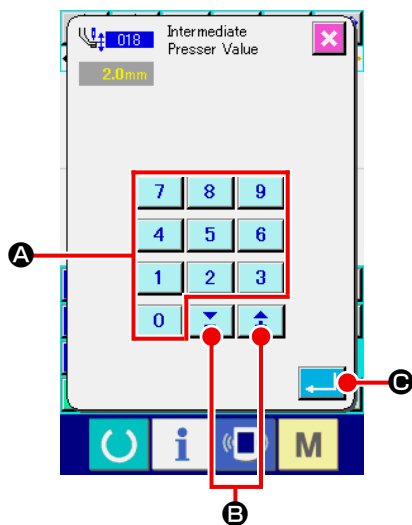

When "50" is set with thread tension reference value (No. 113) and "100" is set with thread tension setting (No. 014), the value to be inputted to the data (increase/decrease value) becomes "50".

(13) Intermediate presser height setting (018)

The intermediate presser height is set. This value is effective up to the position where the next intermediate presser height setting command exists.



① **Select the intermediate presser height setting.**
When selecting and executing INTERMEDIATE PRESSER HEIGHT SETTING (function code 018)  in the code list screen, the left-hand screen is displayed.

② **Perform setting of the intermediate presser height.**
Set the value of thread tension with TEN key  to  **A**, and + or - button  **B** in the left-hand screen and press ENTER button  **C**. Then the value of the set thread tension is inputted, and the screen returns to the standard screen.

When + or - button  **B** is pressed with the intermediate presser lowered, the intermediate presser interlocks and becomes the inputted height.

The value which is really inputted as the command is :
Intermediate presser height setting (No. 018) = Intermediate presser height reference value (No. 115) + value to be inputted to the data (increase/decrease value)



1. When "1.0 mm" is set with intermediate presser height reference value (No. 115) and "3.0 mm" is set with intermediate presser height setting (No. 018), the value to be inputted to the data (increase/decrease value) becomes "2.0 mm".

2. Input can be performed up to 7 mm. However, the actual operation is limited by the setting of the sewing machine.

(14) Area Classification (016)

Area Classification command is inputted.

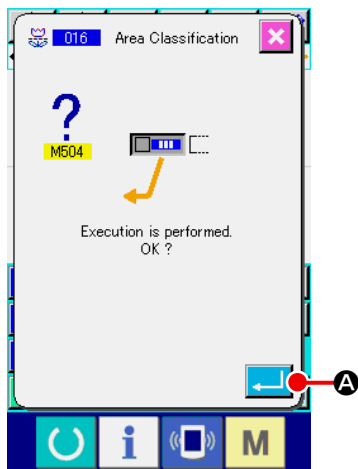

① **Select the area Classification.**

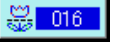
When selecting and executing AREA CLASSIFICATION (function code 016)  in the code list screen, the left-hand screen is displayed.

② **Input the area Classification.**

When ENTER button  **A** is pressed in the right-hand screen, the area Classification command is inputted, and the screen returns to the standard screen.





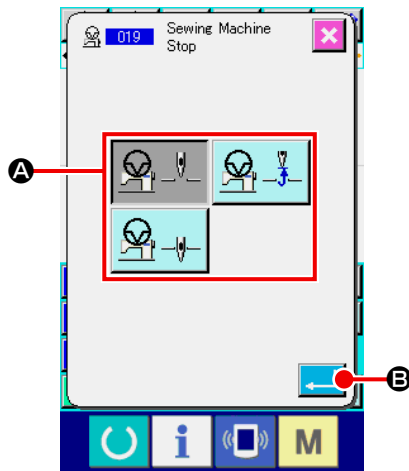

For the operation of the sewing machine in case of setting, refer to the Engineer's Manual.

(15) Sewing machine stop (019)

Sewing machine stop command is inputted.

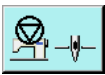

- ① **Select the sewing machine stop.**
When selecting and executing SEWING MACHINE STOP (function code 019)  in the code list screen, the left-hand screen is displayed.
- ② **Specify the stop state.**
Select the needle position at the time of stop from among **A**. The color of the selected button is changed .
- ③ **Input the sewing machine stop.**
When ENTER button  **B** is pressed in the left-hand screen, stop command is inputted, and the screen returns to the standard screen.

Button display	Stop position
	Upper dead point
	UP position
	DOWN position





UP position error will be produced at the time of sewing when the needle position is set to DOWN position at the end of sewing or before jump feed. Needle stop instructions become invalid when the sewing machine is in the stop state, and the needle position does not change.

(16) Machine control command deletion (059)

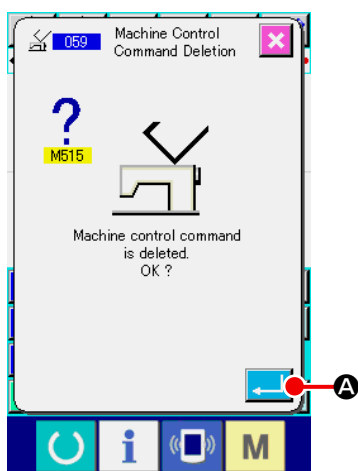
Machine control command of the present position (2nd origin, stop, thread trimming, thread tension set value, intermediate presser height setting, etc.) is deleted.

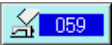



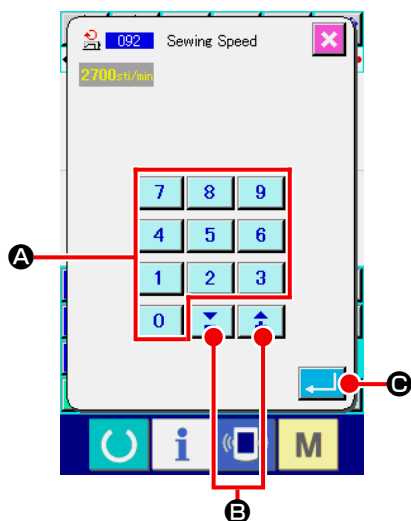

- ① **Select the machine control command deletion.**
When selecting and executing MACHINE CONTROL COMMAND DELETION (function code 059)  in the code list screen, the left-hand screen is displayed.
- ② **Execute the machine control command deletion.**
When ENTER button  **A** is pressed in the left-hand screen, the machine control command is deleted, and the screen returns to the standard screen.

(17) Sewing speed (092)

Sewing speed is inputted.



- ① **Select the sewing speed.**
When selecting and executing SEWING SPEED (function code 092)  in the code list screen, the left-hand screen is displayed.
- ② **Set the sewing speed.**
Set the sewing speed with TEN key  to  **A** and + or - button  **B** in the left-hand screen, and press ENTER button  **C**. Then the sewing speed is inputted with the set value, and the screen returns to the standard screen.

4-6. Automatic back-tack (064)

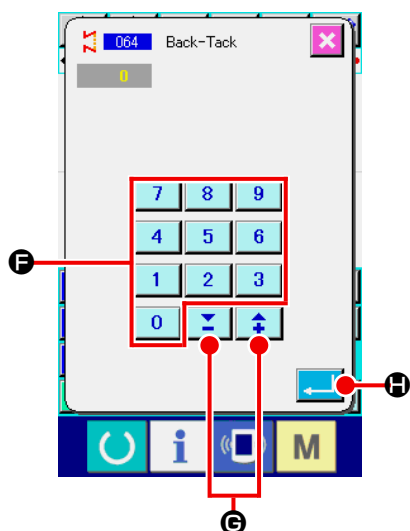
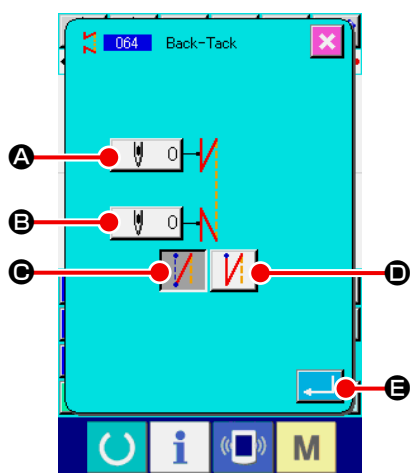

Back-tack of Z type or V type of the specified number of stitches is created to the start of sewing, the end of sewing, or the both of the element including the present point.



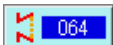



① Select the automatic back-tack.

When selecting and executing AUTOMATIC BACK-TACK (function code 064)  in the code list screen, the automatic back-tack setting screen is displayed.

② Perform setting of the automatic back-tack.

The set value of present number of stitches at the start of sewing is displayed at NUMBER OF STITCHES AT THE START OF SEWING SETTING button  (A), and the set value of present number of stitches at the end of sewing is displayed at NUMBER OF STITCHES AT THE END OF SEWING SETTING button  (B) in the automatic back-tack setting screen.

When the button of the item you desire to change is pressed, the input screen of the set value is displayed. When the number of stitches is set with TEN key  to  (F), and + or - buttons   (G) in the number of stitches setting screen, press ENTER button  (H). Then the set number of stitches is inputted, and the screen returns to the automatic back-tack screen.

The type of back-tack can be specified with BACK-TACK

TYPE SELECTION buttons  (C) and  (D). The button

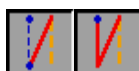

which is changed in color is the type which is

selected now. When V TYPE button  (C) is pressed, V

type back-tack is created, and when Z type button  (D) is pressed, Z type back-tack is created.

After setting, or when it is not necessary to change, press

ENTER button  (E) in the automatic back-tack setting screen. Then the back-tack is created, and the screen returns to the standard screen.

4-7. Condensation sewing (065)

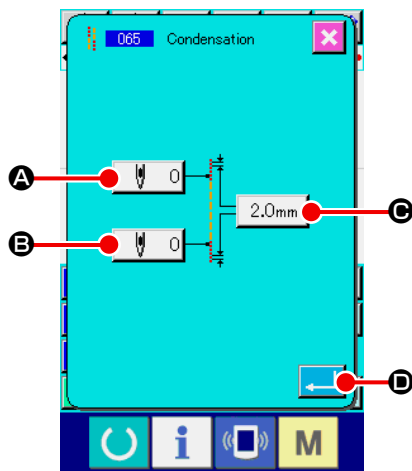

The specified number of stitches of the start of sewing, the end of sewing, or the both of the element including the present point is changed to the specified pitch.



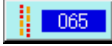



① Select the condensation sewing.

When selecting and executing CONDENSATION SEWING (function code 065)  in the code list screen, the condensation sewing setting screen is displayed.

② Perform setting of the condensation sewing.

The set value of present number of stitches at the start of sewing is displayed at NUMBER OF STITCHES AT THE START OF SEWING SETTING button  **A**, the set value of present number of stitches at the end of sewing is displayed at NUMBER OF STITCHES AT THE END OF SEWING SETTING button  **B**, and the set value of present pitch is displayed at PITCH SETTING button  **C** in the condensation sewing setting screen.

When the button of the item you desire to change is pressed, the input screen of the set value is displayed. Set the value with TEN key  to  **E** and + or - buttons  **F** in the input screen, and press ENTER button  **G**.

Then the set value is inputted, and the screen returns to the condensation sewing setting screen.

When "0" is set as the number of stitches, condensation sewing of the part can be specified without the condensation sewing.

After setting, or when it is not necessary to change, press ENTER button  **D** in the condensation sewing setting screen. Then the condensation sewing is created, and the screen returns to the standard screen.

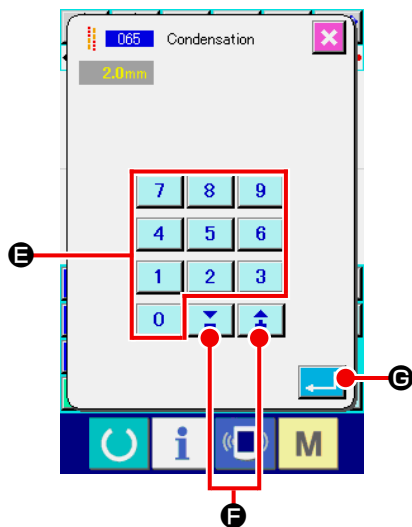

4-8. Overlapped sewing (066)

Overlapped sewing data of the specified number of stitches is created after the present point.

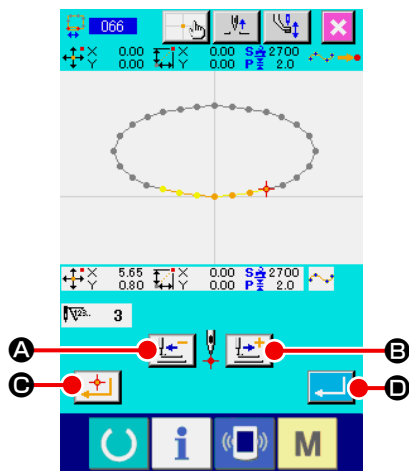

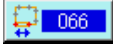

① Select the overlapped sewing.

When selecting and executing OVERLAPPED SEWING (function code 066)  in the code list screen, the overlapped sewing setting screen is displayed.

② Perform setting of the overlapped sewing.

When FEED BACKWARD button  **A** or FEED



FORWARD button  **B** is pressed, the needle entry point can be traced. The present needle position is displayed in red.

When DECIDING POINT button  **C** is pressed, the needle position becomes the object of overlapped sewing which is displayed in pink.

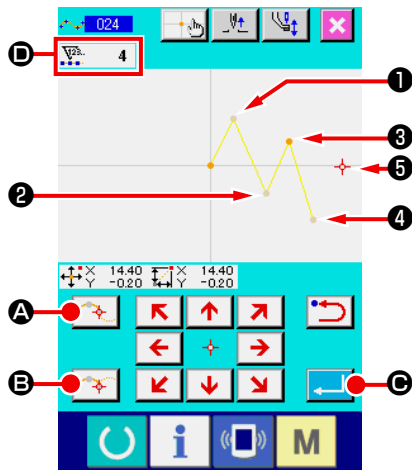

When ENTER button  **D** is pressed, the overlapped sewing element which is set as the object is created, and the screen returns to the standard screen.

4-9. Breakpoint (spline and ordinary sewing)



The breakpoint is the point where two points of the shape point of spline sewing are overlapped, and shows the termination of one spline curve. The point where ENTER button  **C** and DECIDING POINT button  **B** are pressed with the input of spline sewing becomes the breakpoint.

① Input the breakpoint in the spline ordinary sewing.

Select the spline ordinary sewing (function code 024) in the code list screen, and perform the coordinate input of the spline ordinary sewing. Input points **1**, **2** and **4** with PASSING POINT button  **A** and point **3** and point **5** with DECIDING POINT button  **B**, and press ENTER button  **C** at point **5**. Points **3** and **5** become the breakpoints, and the number of input shape points display **D** is added by two.

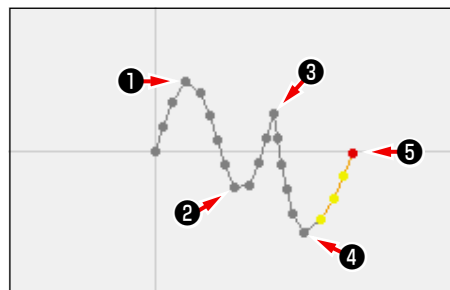

The result is as shown in the figure below. The spline curve ends once at point **3** where the breakpoint is inputted, and a new spline curve is formed up to the next breakpoint **5**. (As the element, one spline sewing is performed.)

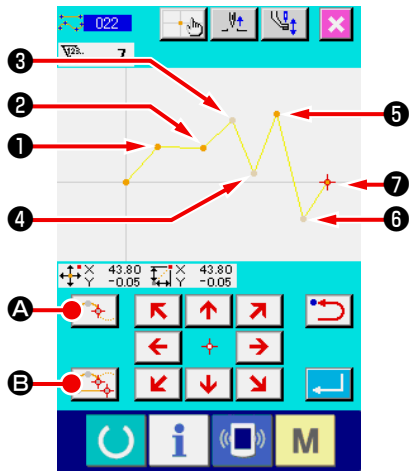



② **Input the breakpoint in the ordinary sewing.**

For the ordinary sewing, the point to be inputted is determined according to the kind of element immediately before the point where DECIDING POINT button  **B** is pressed.

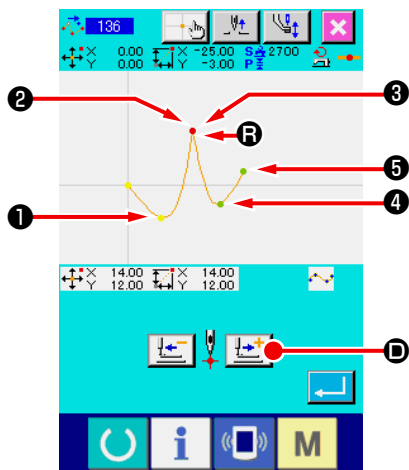
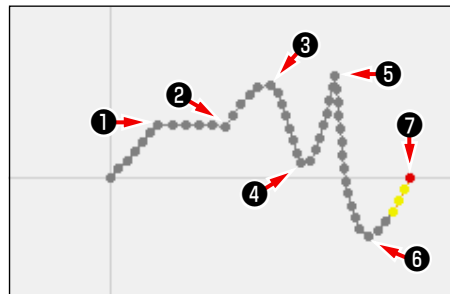

Select ORDINARY SEWING (function 022) , and input points **1** , **2** , **5** and **7** with DECIDING POINT button  **B** and points **3** , **4** and **6** with PASSING POINT button  **A** in the coordinate input screen.

In this case, point **2** becomes the normal deciding point (number of shape points + 1) since the point that is one before point **2** is the linear sewing, and point **5** and point **7** become the breakpoints (number of shape points + 2) since the point before the points **5** and **7** is the spline sewing.



③ **Perform modification of the shape point with the breakpoint.**

It is necessary to be careful when performing the modification of the shape point ("[5-8. Shape point modification](#)" p.75) since the breakpoint is the point where the shape point is overlapped twice.

Select SHAPE POINT MOVE (function code 136) , and select the shape point to be moved. Press FEED FORWARD button  **D** and advance the shape point to be selected. Then you will find that there are two points of the shape point at the breakpoint (point **B**).

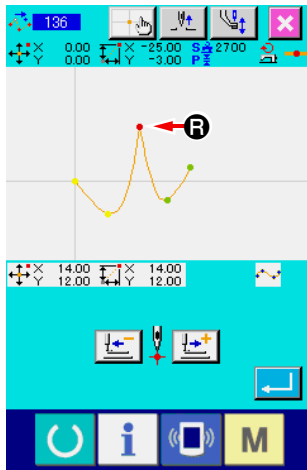

When you desire to move point **R** to point **S**, the result will be changed by selecting either shape point of rear **2** or front **3**.

The result when point of rear **2** has been moved.

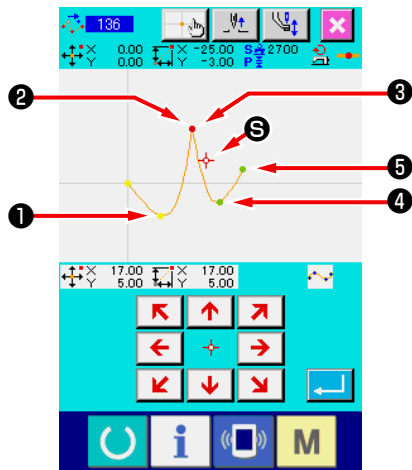
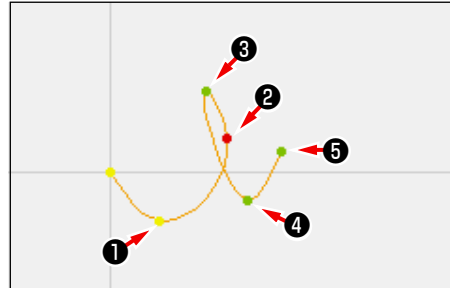

The result when point of front **3** has been moved.

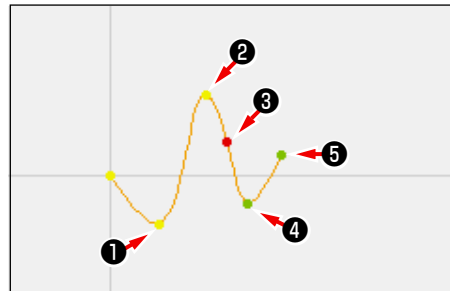

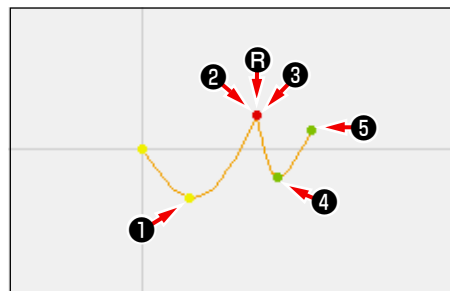

Point **R** can be moved by moving both point of rear **2** and point of front **3** to the same coordinates.

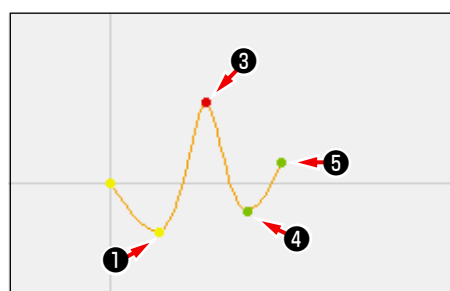

When performing the shape point deletion of either point of rear **2** or point of front **3**, the breakpoint becomes the normal passing point and the continuous spline sewing is formed.





5. MODIFICATION OF THE PATTERN

To perform the modification of the pattern, move the needle position to the modifying position using beforehand FEED BACKWARD key  or FEED FORWARD key  in the standard screen.

5-1. Point modification

(1) Point deletion (070 and 074)

The pattern data of the specified section is deleted in needle entry point unit. There are two methods of RELATIVE POINT DELETION  AND ABSOLUTE POINT DELETION  depending on moving of the pattern data after the deleted point.

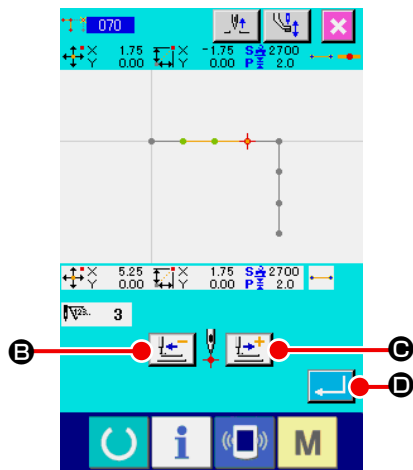

Point deletion can delete not only the pattern data which is created with point sewing input, but also the data inputted with any function such as linear sewing or the like.

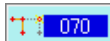

① **Select the relative point deletion.**

Select and execute RELATIVE POINT DELETION (function code 070)  in the code list screen.

② **Specify the relative point deletion range.**

Move the needle position and specify the section of the deleting points by pressing FEED BACKWARD key  B or FEED FORWARD key  C, and press ENTER button  D.

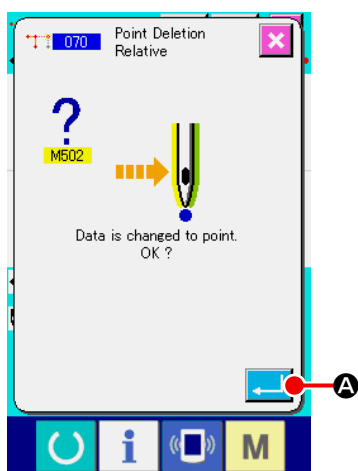

③ **Confirm the point change.**

The point change confirmation screen shows that the point change may be changed to the point sewing. In case of continuing, press ENTER button  A, and the point deletion confirmation screen is displayed.

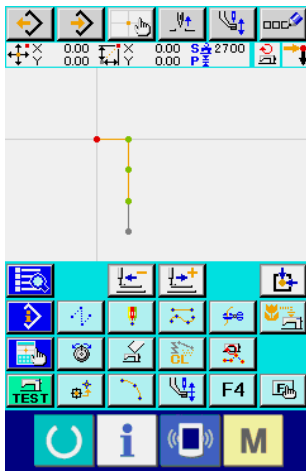
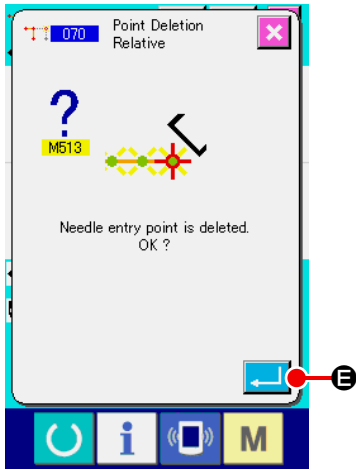

④ Execute the relative point deletion.

When ENTER button  is pressed in the point deletion confirmation screen, the point deletion is executed, and the screen returns to the standard screen.

In case of the relative point deletion, the whole pattern data after the deleted point moves while holding the relation before deletion.

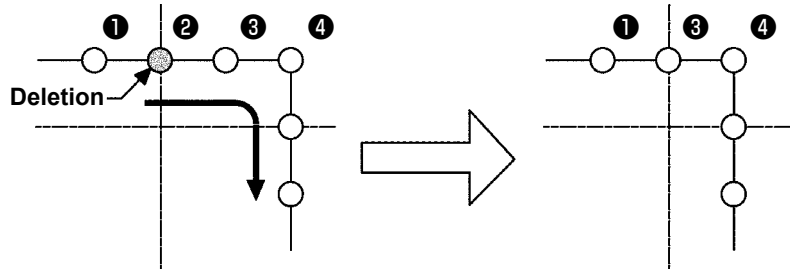

Relative point deletion

In case of the absolute point deletion, select and execute ABSOLUTE POINT DELETION (function code 074)  in the code list screen. In this case, the pattern data after the deleted point does not move.

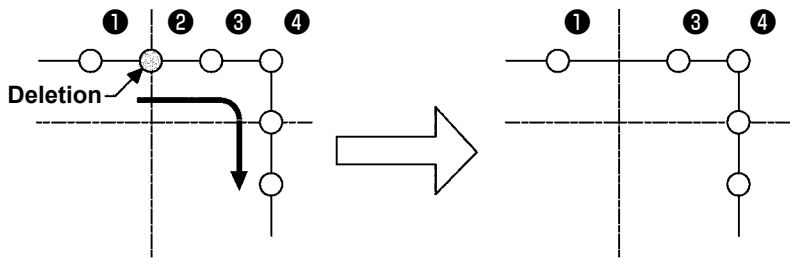

Absolute point deletion



1. As the result of deleting the point, be careful that the distance of change does not exceed the maximum stitch length of the sewing machine.
2. As the result of deleting the point, there is a case where a part of the created pattern exceeds the sewing area.
In such a case as this, modify the pattern data so that it is put within the sewing area using the modification function.

(2) Point move (071 and 075)

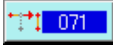
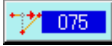
This function moves the specified needle entry point. There are two methods of RELATIVE POINT MOVE  and ABSOLUTE POINT MOVE  depending on moving of the pattern data after the moved point.

The point move can move not only the pattern data created with the point sewing input, but also the data inputted with any function such as linear sewing or the like. In case of the linear sewing or the like, when the point move is executed, it is changed to the point sewing.

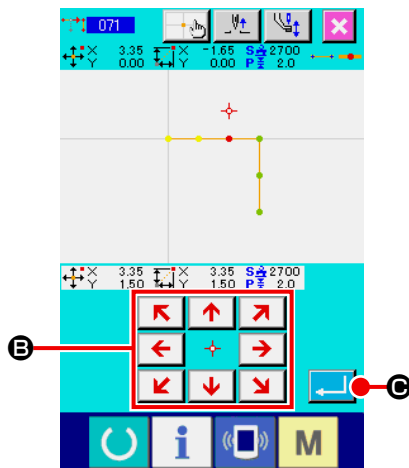

① Select the relative point move.

Select and execute RELATIVE POINT MOVE (function code 071)  in the code list screen.

② Specify the relative point move position.

Specify the move position of the point using MOVE key

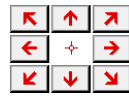

B, and press ENTER button  **C**.

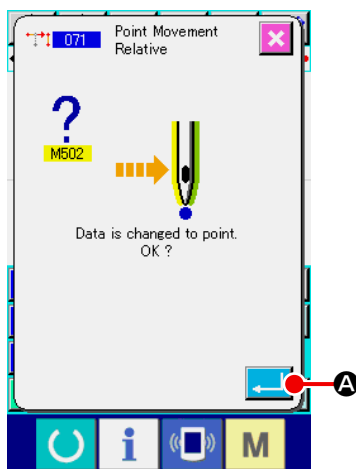

③ Confirm the point change.

The point change confirmation screen shows that the point change may be changed to the point sewing. In case of continuing, press ENTER button  **A**, and the point move is executed. Then the screen returns to the standard screen.

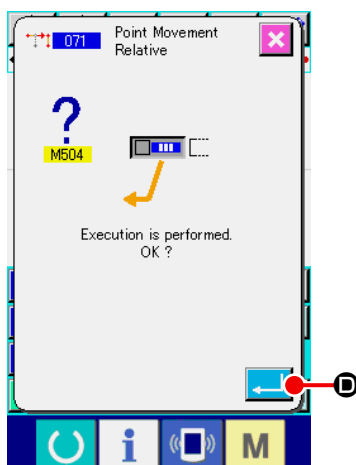

④ Execute the relative point move.

When ENTER button  **D** is pressed in the relative point confirmation screen, the point move is executed, and the screen returns to the standard screen.

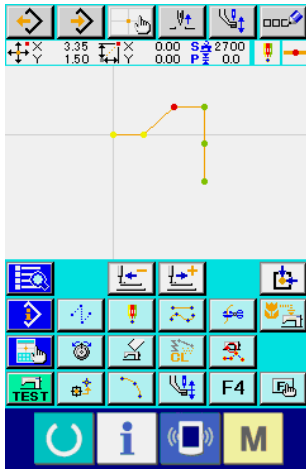

In case of the relative point move, the whole pattern data after the moved point moves while holding the previous relation.

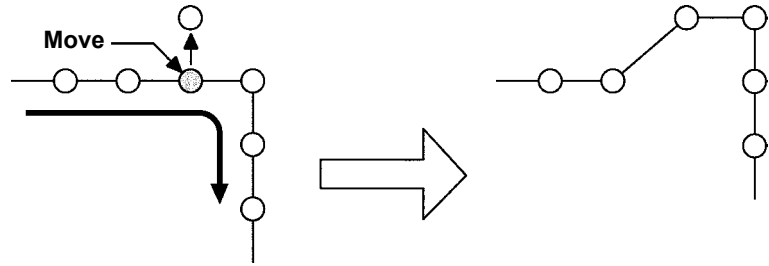

Relative point move

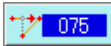
In case of the absolute point move, select and execute ABSOLUTE POINT MOVE (function code 075)  in the code list screen.

In this case, the pattern data after the moved point does not move.

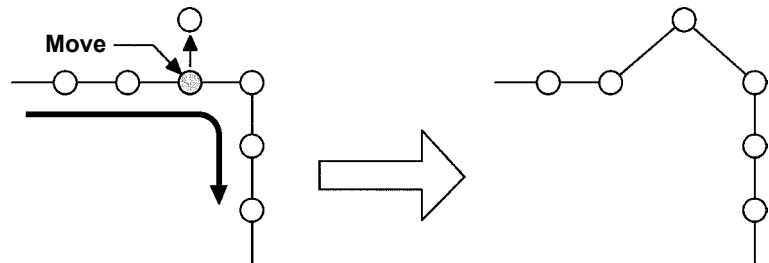

Absolute point move



1. After the result of moving the point, be careful that the distance of change does not exceed the maximum stitch length of the sewing machine.
2. As the result of moving the point, there is a case where a part of the created pattern data exceeds the sewing area.
In such a case as this, modify the pattern data so that it is put within the sewing area using the modification function.

(3) Point adding (076)

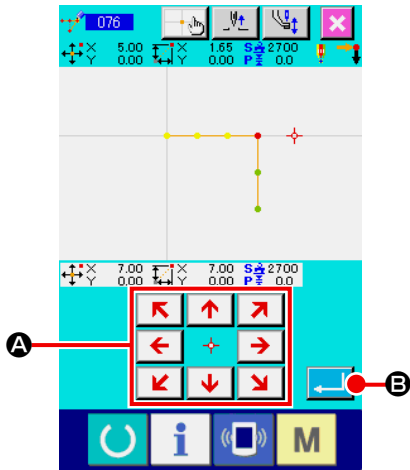

The point is added after the specified needle entry point. The pattern data after the added point does not move. Point adding can be added to not only the pattern data created with the input of point sewing, but also the data inputted with any function such as linear sewing or the like.

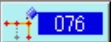
- ① Select the absolute point adding.**
 Select and execute ABSOLUTE POINT ADDING (function code 076)  in the code list screen.

- ② Specify the absolute point adding position.**
 Specify the adding position of the point using MOVE key

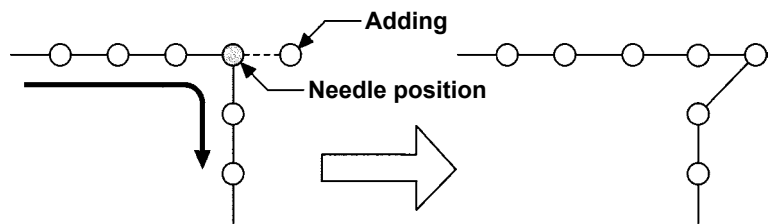
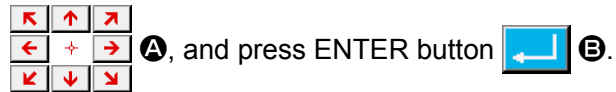

Absolute point adding

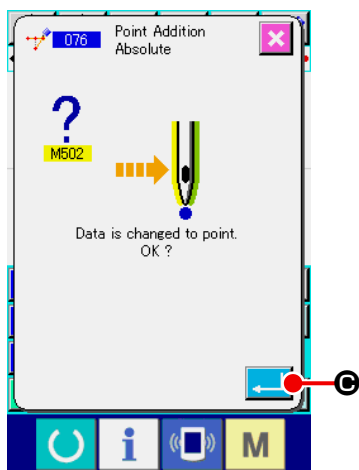

- ③ Confirm the absolute point adding.**
 The point change confirmation screen shows that the point change may be changed to the point sewing. In case of continuing, press ENTER button  **C**, and the point move is executed. Then the screen returns to the standard screen.

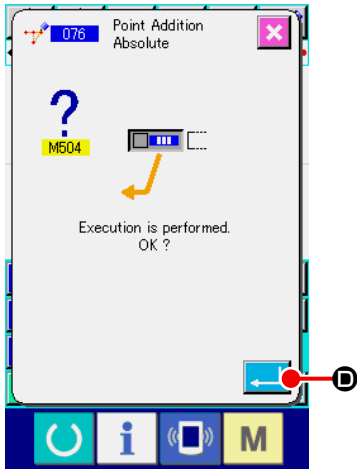

④ **Execute the absolute point adding.**

When ENTER button  **D** is pressed in the absolute point adding confirmation screen, point adding is executed and the screen returns to the standard screen.

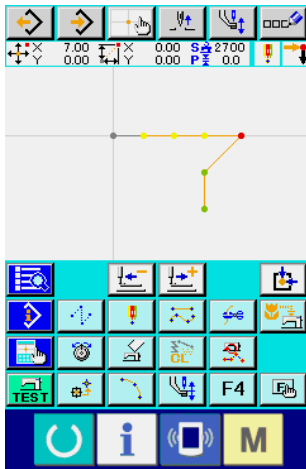



1. As the result of adding the point, be careful that the distance of change does not exceed the maximum stitch length of the sewing machine.

2. As the result of adding the point, there is a case where a part of the created pattern data exceeds the sewing area.

In such a case as this, modify the pattern data so that it is put within the sewing area using the modification function.

5-2. Vertex modification

(1) Vertex deletion (072 and 077)

This function deletes one specified vertex of the pattern data. There are two methods of RELATIVE VERTEX DELETION  and ABSOLUTE VERTEX DELETION  depending on moving of the pattern data after the deleted point.

This function cannot be executed when the specified point is the needle entry point other than the vertex of the element.

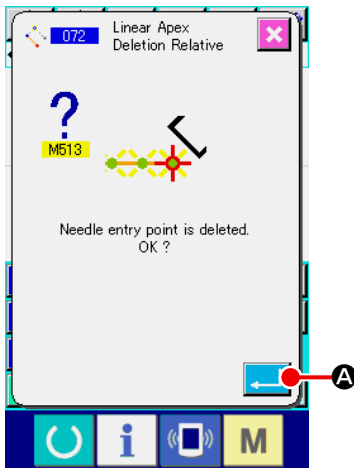

① Select the relative vertex deletion.

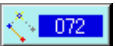
When selecting and executing RELATIVE VERTEX DELETION (function code 072)  in the code list screen, the relative vertex deletion confirmation screen is displayed.

② Execute the relative vertex deletion.

When ENTER button  **A** is pressed in the relative vertex deletion confirmation screen, the relative vertex deletion is executed, and the screen returns to the standard screen.

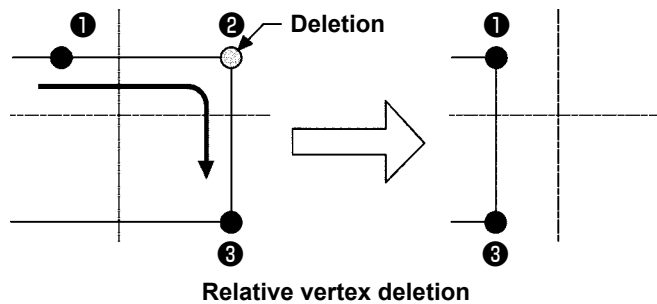

In case of the relative vertex deletion, the whole pattern data after the deleted point moves while holding the relation before deletion.

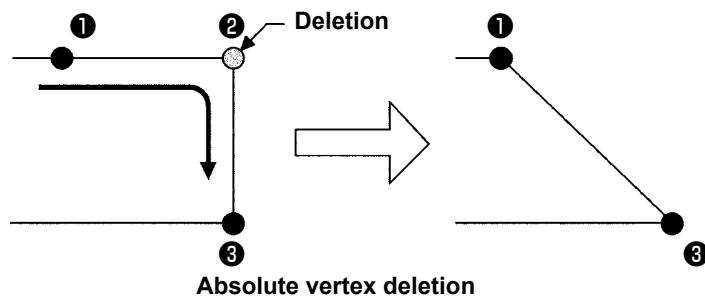

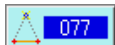
In case of the absolute vertex deletion, select and execute ABSOLUTE VERTEX DELETION (function code 077)  in the code list screen.

In this case, the pattern data after the deleted point does not move.



As the result of deleting the point, there is a case where a part of the created pattern data exceeds the sewing area. In such a case as this, modify the pattern data so that it is put within the sewing area using the modification function.

(2) Vertex move (073 and 078)

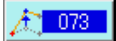
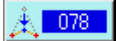
This function moves the specified needle entry point. There are two methods of RELATIVE VERTEX MOVE  and ABSOLUTE VERTEX MOVE  depending on moving of the pattern data

In case of the relative vertex move : This function cannot be executed when the specified point the needle entry point other than the vertex.

In case of the absolute vertex move : This function cannot be executed when the specified point is the last needle entry point of the element or the needle entry point other than the vertex.

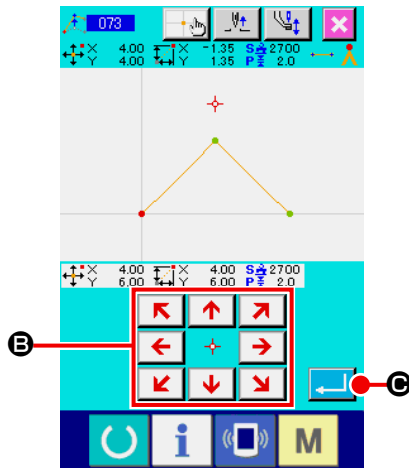

① Select the relative vertex move.

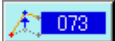
Select and execute RELATIVE VERTEX MOVE (function code 073)  in the code list screen.

② Specify the relative vertex move position.

Specify the moving position of the vertex using MOVE key



in the relative vertex move position specifying screen, and press ENTER button  **C**. Then the machine control command deletion confirmation screen is displayed.



When the  is pressed on the machine control command deletion confirmation screen, the machine control command information recorded for needle entry points are deleted. Information on thread trimming, external output, thread tension setting, sewing machine stopping, sewing speed delay, 2nd origin, pause and sewing machine rotation are deleted.

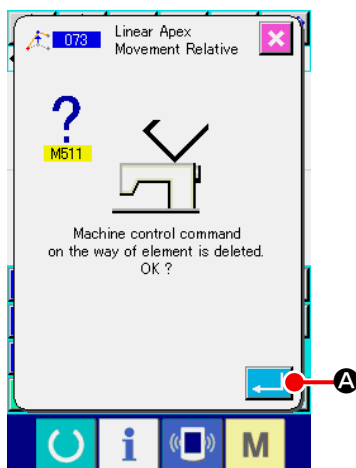

③ Execute the vertex move.

When ENTER button  **A** is pressed in the machine control command deletion confirmation screen, the vertex move is executed, and the screen returns to the standard screen.

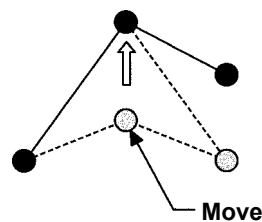

Relative vertex move

In case of the relative vertex move, the whole pattern data after the moved point moves while holding the relation before moving.

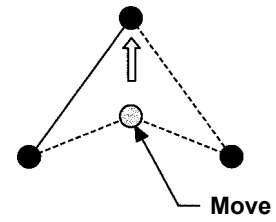

Absolute vertex move

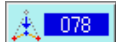
In case of the absolute vertex move, select and execute ABSOLUTE VERTEX MOVE (function code 078) . In case of the absolute vertex move, the pattern data after the moved point does not move.



As the result of moving the point, there is a case where a part of the created pattern data exceeds the sewing area. In such a case as this, modify the pattern data so that it is put within the sewing area using the modification function.

5-3. Element deletion (063)

This function deletes sewing element and machine command in terms of element.
All elements after deletion move so as to advance as many as the deleted elements.

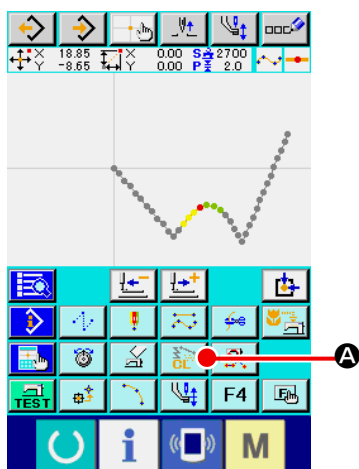

① Display the element deletion executing screen.

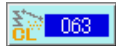
When pressing ELEMENT DELETION button  **A** in the standard screen, or selecting and executing ELEMENT DELETION (function code 063)  in the code list screen, the element deletion executing screen is displayed.

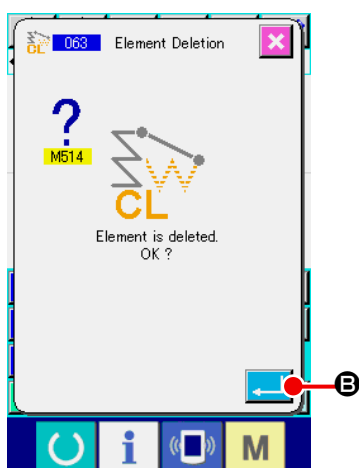

② Execute the element deletion.

When ENTER button  **B** is pressed in the element deletion screen, the element deletion is executed, and the screen returns to the standard screen.

When the elements to which the present needle position belongs are deleted, the whole pattern data after the deleted elements moves so as to advance, and the needle position moves to the sewing end point of the element immediately before the deleted elements.

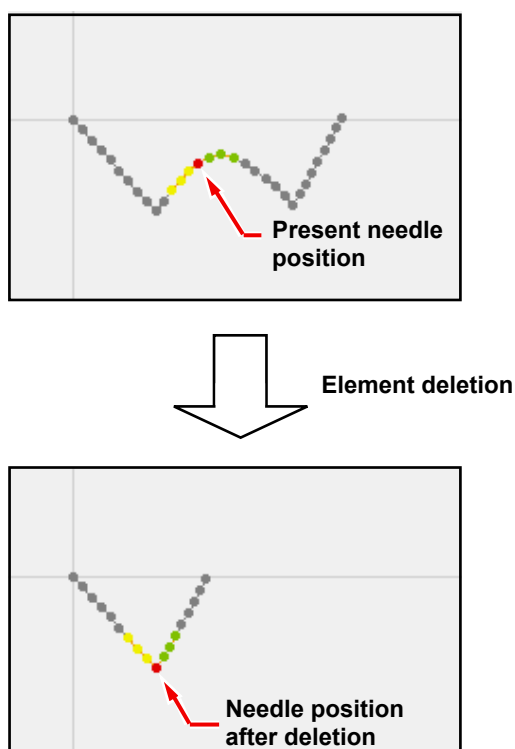



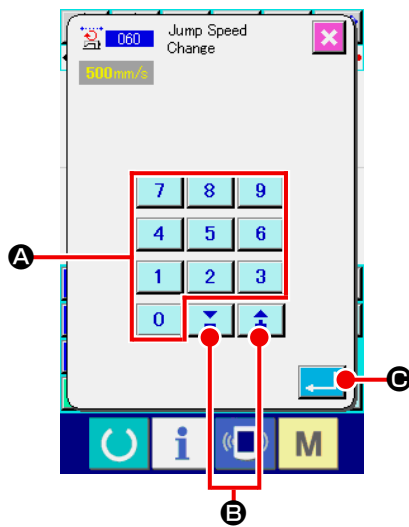

5-4. Jump feed speed change (060)

Jump feed speed can be changed to the created jump feed element in terms of element.



① **Display the jump feed speed change setting screen.**
When selecting and executing JUMP FEED SPEED CHANGE (function code 060)  in the code list screen, the jump feed speed change setting screen is displayed.

② **Input the changing jump feed speed.**

Set the jump feed speed after change with TEN key  to  **A**, and + or - button  **B** in the jump feed speed change setting screen. When ENTER button  **C** is pressed, the confirmation screen is displayed.

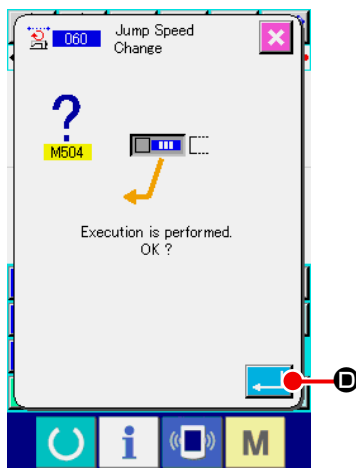

③ **Execute the jump feed speed change.**



When ENTER button  **D** is pressed in the jump feed speed change confirmation screen, the speed of element is changed, and the screen returns to the standard screen.

5-5. Sewing speed section change (061)

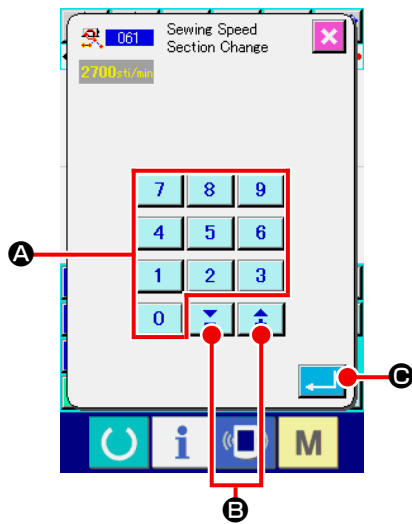



Sewing speed can be limited to the created element in terms of needle entry point.



① Display the sewing speed section change setting screen.



Press SEWING SPEED SECTION CHANGE button  in the standard screen or select and execute SEWING SPEED SECTION CHANGE (function code 061)  in the code list screen, the sewing speed section change setting screen is displayed.

② Input the changing speed.

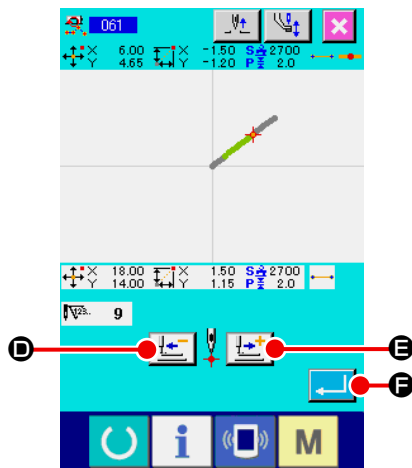
The speed after change is set with TEN key  to  **A**, and + or - button   **B** in the sewing speed section change setting screen. When ENTER Button  **C** is pressed, the sewing speed section change range specifying screen is displayed.



③ Specify the range of changing speed.

When FEED BACKWARD button  **D** or FEED FORWARD button  **E** is pressed, the needle entry point can be traced. When ENTER button  **F** is pressed, the point speed of the range set as the object is changed, and the screen returns to the standard screen.

5-6. Sewing pitch change (062)

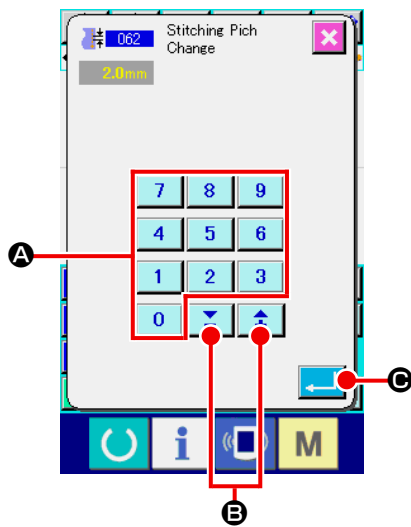

Sewing pitch between the specified elements can be changed to the created element.



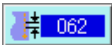



① Display the sewing pitch change setting screen.

When selecting and executing SEWING PITCH CHANGE (function code 062)  in the code list screen, the sewing pitch change setting screen is displayed.

② Input the changing sewing pitch.

Set the sewing pitch after change with TEN key  to 



, and + or - button   in the sewing pitch change setting screen.

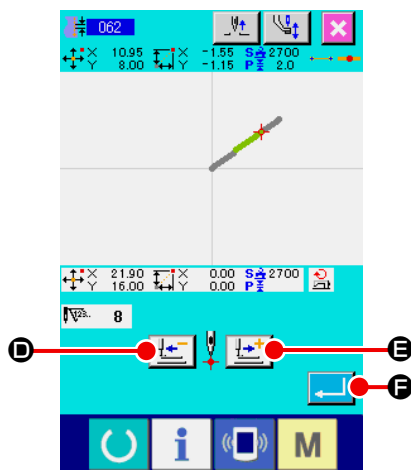

When ENTER button   is pressed, the sewing pitch change range specifying screen is displayed.



③ Specify the range of changing the sewing pitch.

When FEED BACKWARD button   FEED FORWARD

button   is pressed, the needle entry point can be traced.

When ENTER button   is pressed, the sewing pitch of the element including the range set as the object is changed, and the screen returns to the standard screen.

5-7. Symmetry



A figure which is symmetrical to the created pattern is created. Taking the present needle position as the reference, this function is performed to the whole pattern. When executing this function, set the present needle position to the position of the reference beforehand.

(1) X-axis symmetry (082)

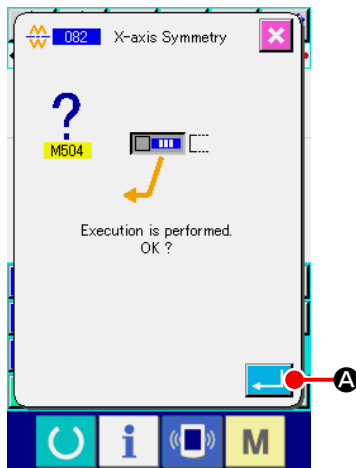
A figure which is symmetrical to X-axis passing the present needle position is created. The present pattern is kept as it is, and the symmetrical pattern is added after it.

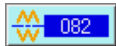

① Execute X-axis symmetry

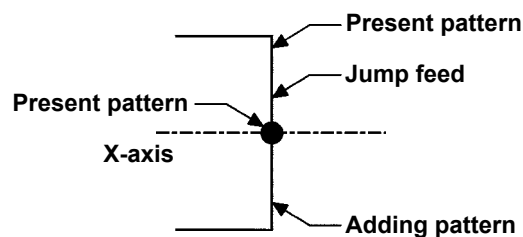

When selecting and executing X-AXIS SYMMETRY (function code 082)  in the code list screen, the confirmation screen is displayed. When ENTER button  **A** is pressed in the confirmation screen, X-axis symmetry is executed.



(2) Y-axis symmetry (083)

A figure which is symmetrical to Y-axis passing the present needle position is created. The present pattern is kept as it is, and the symmetrical pattern is added after it.

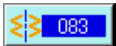
① Execute Y-axis symmetry.

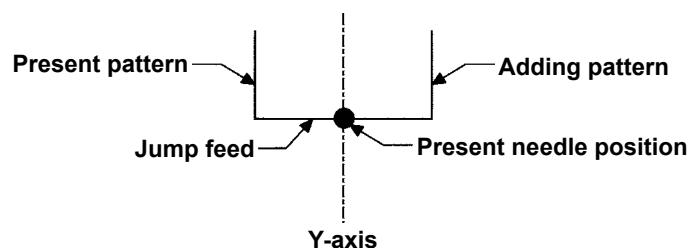

Select Y-AXIS SYMMETRY (function code 083)  in the code list screen, and press ENTER button  **A** in the confirmation screen. Then Y-axis symmetry is executed.



(3) Point symmetry (084)

Taking the present needle position as reference, a symmetrical figure is created. The present pattern is kept as it is, and the symmetrical pattern is added after it.

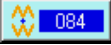
① Execute the point symmetry.

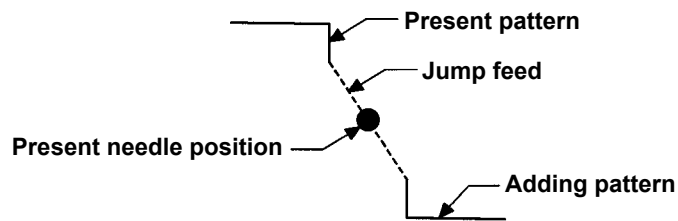

When selecting and executing POINT SYMMETRY (function code 084)  in the code list screen, and pressing ENTER button  in the confirmation screen, the point symmetry is executed.



(4) Y symmetry pattern inversion orderly sewing (098)

A figure which is symmetrical to Y-axis passing the present needle position is created. The present pattern is erased, and jump feed is added up to the top of the symmetrical pattern.

① Execute the Y symmetry pattern inversion orderly sewing.

Select Y SYMMETRY PATTERN INVERSION ORDERLY SEWING (function code 098)  in the code list screen, press ENTER button  in the confirmation screen, and Y symmetry pattern inversion orderly sewing is executed.

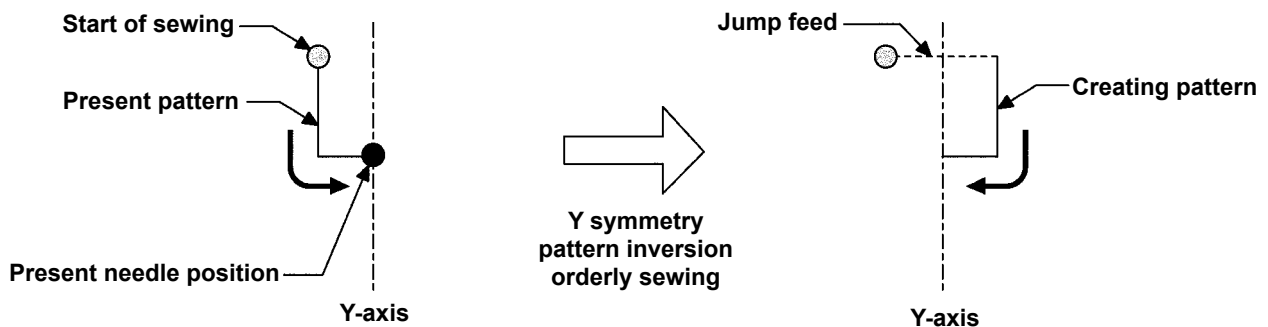

5-8. Shape point modification

Modification of the shape point of element including the present point is performed.

(1) Shape point adding (135)

Adding of the shape point is performed.

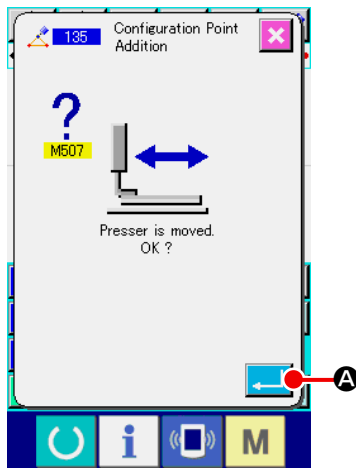



① Select the shape point adding.

When selecting and executing SHAPE POINT ADDING (function code 135)  in the code list screen, the presser move confirmation screen is displayed.

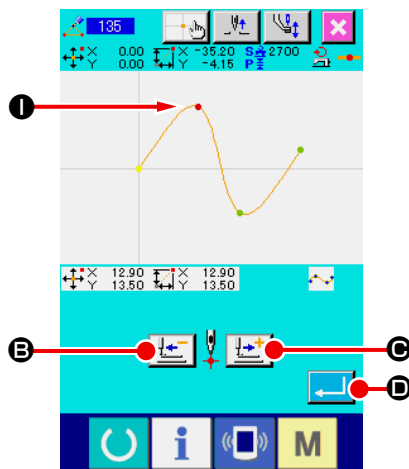
When ENTER button  **A** is pressed, the presser moves up to the 1st shape point, and the shape point specifying screen is displayed.



② Specify the shape point.



Specify the shape point of the adding source using FEED BACKWARD button  **B** or FEED FORWARD button  **C**.

The new shape point is added after the shape point specified here. The specifying shape point is displayed in red **1**.

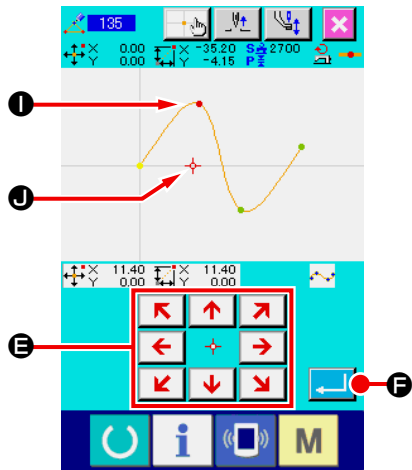
When the shape point is selected, and ENTER button  **D** is pressed, the shape point position specifying screen is displayed.

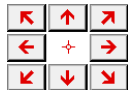

③ Specify the adding position.

Using MOVE key  **E**, specify the position of adding destination of shape point with CURSOR  **J**, and press ENTER button  **F**.

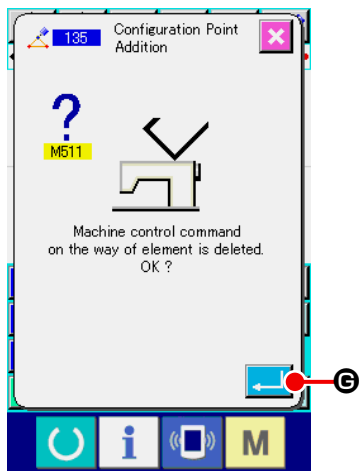

④ Delete the machine control command.

As the machine control command deletion confirmation screen is displayed, press ENTER button  **G** if the machine control command on the way of element may be deleted. Then the shape point adding is executed, and the screen returns to the standard screen.

Example that shape point **J** is added after shape point **I** is as shown in the figure below.

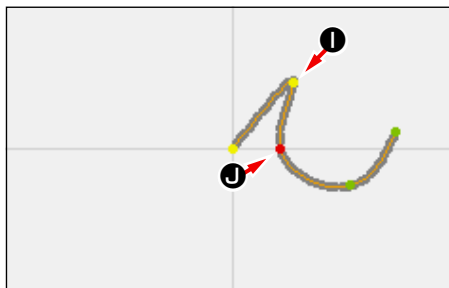

(2) Shape point move (136)

Move of the shape point is performed.

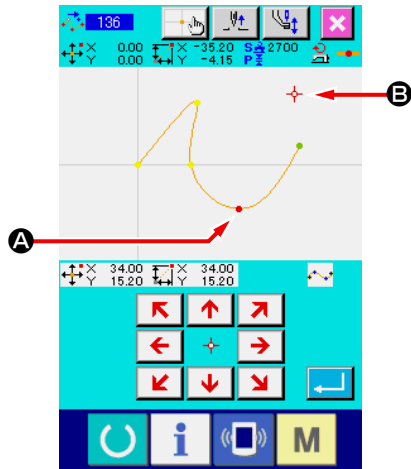

① Select the shape point move.

Select and execute SHAPE POINT MOVE (function code 136)

 is the code list screen.

Operating procedure of the shape point move is the same as that of **“5-8.(1) Shape point adding (135)” p.75**. After confirming the move of presser, select the shape point to be moved, and specify the position of moving destination in the position specifying screen of the right-hand figure.

After specifying the position and performing confirmation of the machine control command deletion, the shape point move is executed.

Example that shape point **A** is moved to shape point **B** is as shown in the figure below.

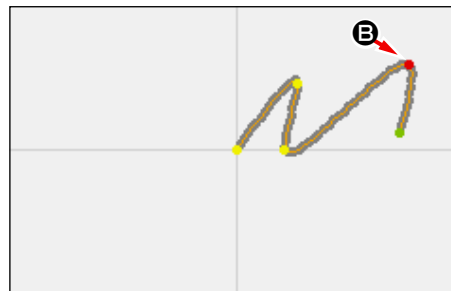

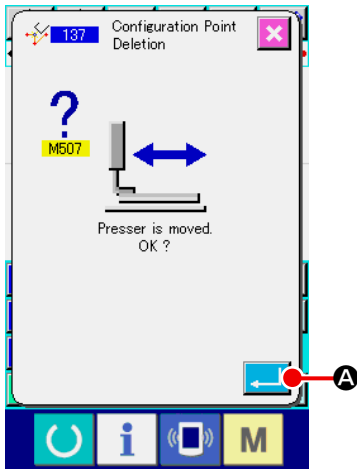

(3) Shape point deletion (137)

Deletion of the shape point is performed.





① **Select the shape point deletion.**

When selecting and executing SHAPE POINT DELETION (function code 137)  in the code list screen, the presser move confirmation screen is displayed.

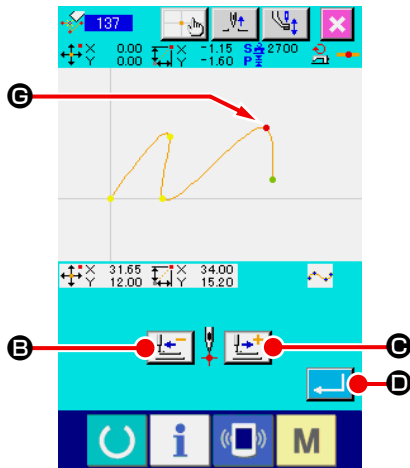
When ENTER button  **A** is pressed, the presser moves, and the shape point specifying screen is displayed.



② **Specify the shape point.**

Specify the deleting shape point using FEED BACKWARD button  **B** or FEED FORWARD button  **C**.

Select the shape point, and press ENTER button  **D**.

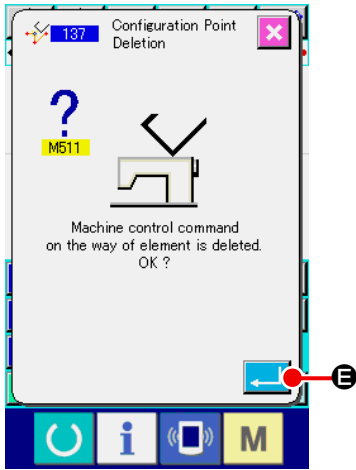

③ **Delete the machine control command.**

As the machine control command deletion confirmation screen is displayed, press ENTER button  **E** if the machine control command on the way of element may be deleted.



④ **Execute the shape point deletion.**

When ENTER button  **F** is pressed in the shape point deletion confirmation screen, the shape point deletion is executed, and the screen returns to the standard screen.

Example that shape point **G** is deleted is as shown in the figure below.

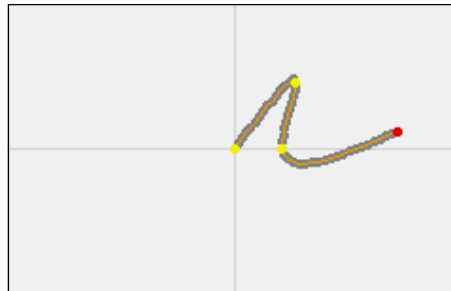

6. PATTERN OPERATION

6-1. Pattern copy (086)

Copy of the created pattern is performed up to the maximum 10 copies.

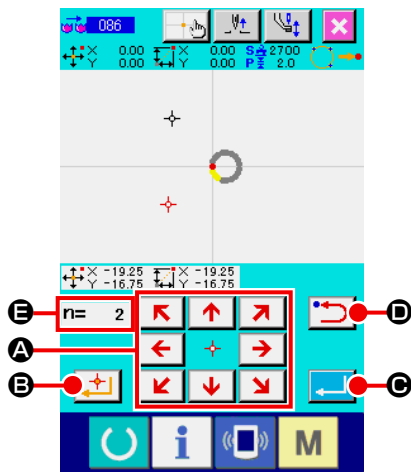

① **Select the pattern copy.**

When selecting and executing PATTERN COPY (function code 086)  in the code list screen, the pattern copy position specifying screen is displayed.

② **Specify the copy destination of the pattern.**

Adjust the copy destination to the position you desire using

MOVE key  **A**.

③ **Determine the copy destination of the pattern.**

When DECIDING POINT button  **B** is pressed, the point is set to the copy destination.

④ **Execute the pattern copy.**

When ENTER button  **C** is pressed, the confirmation screen is displayed.

⑤ **When ENTER button  **F** is pressed in the pattern copy confirmation screen, the pattern copy is executed and the screen returns to the standard screen.**

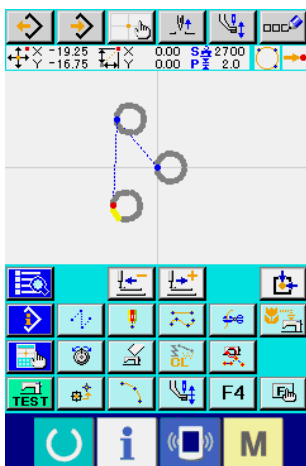
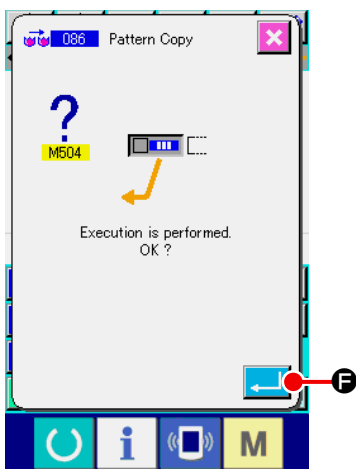

1. Operation of ② and ③ can input repeatedly up to the maximum 10 times. Number of input points is displayed at **E**.
2. In operation of ④, the copy point already inputted can be deleted with BACKWARD button  **D** before pressing ENTER button.
3. Taking the present needle position as the reference, this function is performed for the whole pattern. Thread trimming enters at the sewing end point of the original pattern, and jump feed enters up to the sewing start point of the copy destination.



Caution Copy cannot be performed when the present point is the point of jump feed before the sewing is produced.

6-2. Pattern move (085)

Parallel move of the created pattern is performed.

Positioning can be performed with ease by moving the present position to the position where you desire to move.

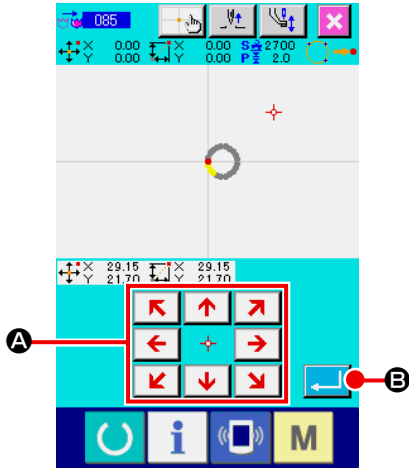

① **Move to the reference position.**

Move the pattern up to the reference position where you desire to move the present point with FEED FORWARD button or FEED BACKWARD button in the standard screen.

② **Select the pattern move.**

When selecting and executing PATTERN MOVE (function code 085)  in the code list screen, the pattern move position specifying screen is displayed.

③ **Specify the move destination of the pattern.**

Adjust the move destination to the position you desire using

MOVE KEY  (A).

④ **Execute the pattern move.**

When ENTER button  (B) is pressed, the confirmation screen is displayed.

⑤ **When ENTER button  (C) is pressed in the pattern move confirmation screen, the pattern move is executed and the screen returns to the standard screen.**

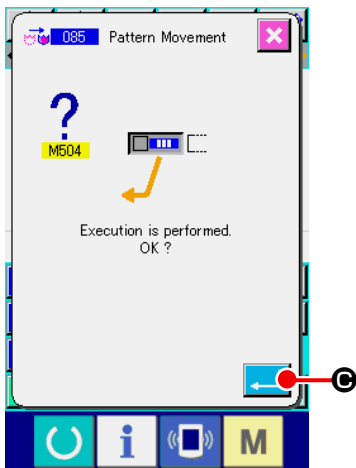

1. Taking the present needle position as the reference, this function is performed for the whole pattern. Jump feed data of the moved portion enters the top of the pattern.
2. It is not possible to select the function when the present position is the origin.

6-3. Pattern erase (087)

All created pattern data are erased.

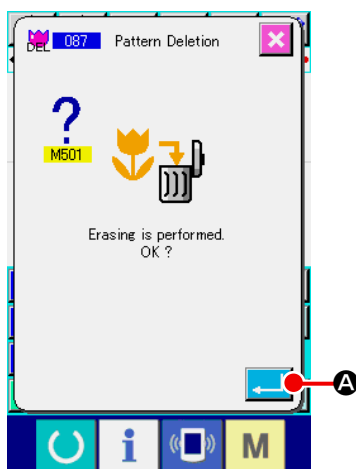

① **Select the pattern erase.**

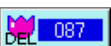
When selecting and executing PATTERN ERASE (function code 087)  in the code list screen, the pattern erase confirmation screen is displayed.

② **Execute the pattern erase.**

When ENTER button  **A** is pressed, the pattern erase is executed, and the screen returns to the standard screen. All inputted pattern data are erased, the feed moves, and the needle position returns to the origin.



1. Erased pattern data cannot be restored.
2. When creating a new pattern again after writing the pattern data to the media once, or when reading other pattern from the media, use this function and erase the pattern data once.
When performing the pattern reading without erasing the pattern, it is read out additionally after the present needle position of the pattern data which has been already created.

6-4. Pattern reading

Pattern data is read.



Use the media which has been formatted with IP-420.

(1) Read the pattern data

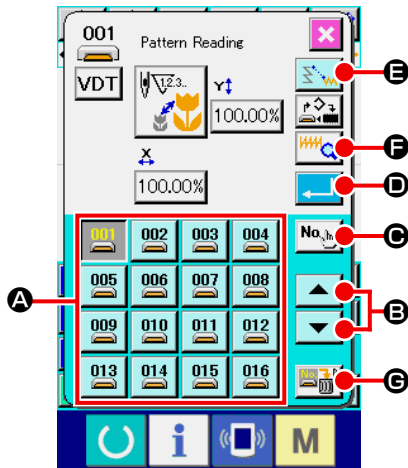

① Select the pattern reading.

When PATTERN READ button is pressed in the standard screen, the pattern reading screen is displayed.

② Select the pattern to read.

The pattern existing in the media is displayed in section **A** with button . When the button of the pattern you desire to read is pressed, the color of the button is changed .

When the number of patterns is more than 16, "↑" key and "↓" key are displayed at section **B**. By pressing these buttons, the pattern displayed in section **A** can be changed over.

③ Specify direct the pattern No.

When PATTERN NO. SPECIFYING BUTTON **C** is pressed, the pattern No. specifying screen is displayed.

Pattern No. can be inputted with TEN key to **H**, or + or - key **I**. When + or - key is pressed, the pattern No. existing next the pattern inputted now is inputted.

When ENTER button **J** is pressed, the screen returns to the pattern reading screen with the inputted pattern No. selected.

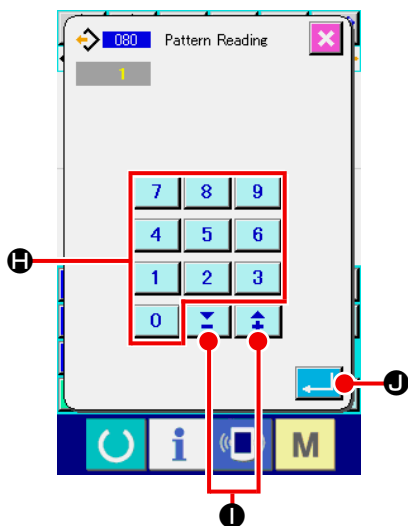





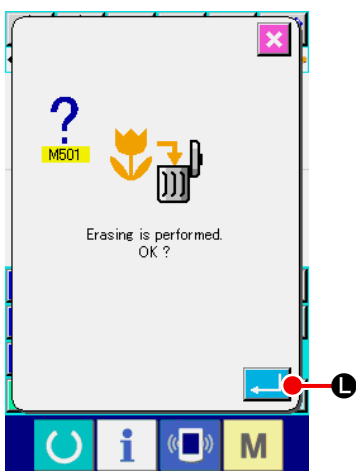
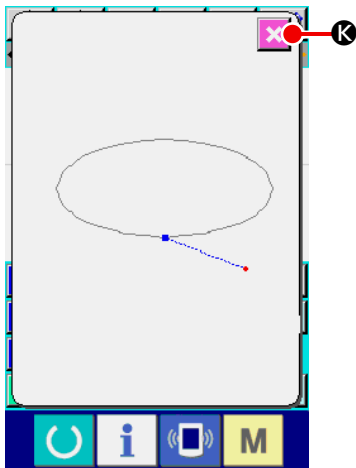

④ Execute the pattern reading.

When ENTER button **D** is pressed, the selected pattern data reading is executed, and the screen returns to the standard screen.



1. When PATTERN INFORMATION button  is pressed, the pattern information screen is displayed, and the pattern data information on the pattern No. which is being selected now can be confirmed.

The screen return to the pattern reading screen with CANCEL button  **K**.



2. When JUMP FEED READ button  **E** is pressed, it is possible to select whether deleting  , or not deleting  jump feed up to the sewing at the time of pattern data reading. The present setting state is displayed at the jump feed read button, and the setting is changed over alternately ( and ) every time the button is pressed.

3. When PATTERN ERASE button  **C** is pressed, the pattern erase screen is displayed.

When ENTER button  **L** is pressed, it is possible to erase the pattern data of the pattern No. which is being selected now from the inside of media.

Taking the present needle position of the pattern data which has been already created as the origin, the pattern reading is added after the position.



It is possible to read at the optional position of the pattern data by moving the needle position on the created pattern data using FEED BACKWARD button  or FEED FORWARD button  in the standard screen.

(2) Set the enlargement/reduction ratio

It is possible to read the enlarged or reduced pattern by setting enlargement/reduction ratio beforehand. Enlargement/reduction is possible only when the reading data is VDT format data.

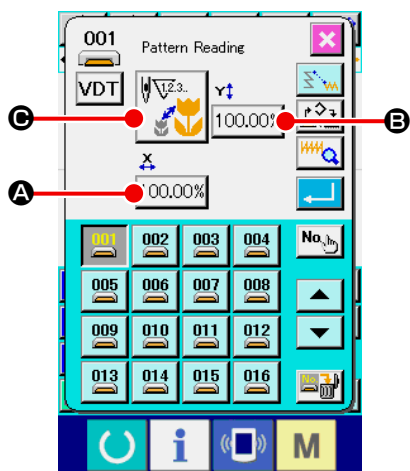

① Set X enlargement/reduction ratio.

When X ENLARGEMENT/REDUCTION RATIO SETTING button **100.00%** **A** is pressed, the X enlargement/reduction ratio setting screen is displayed.

The set value of the present X enlargement/reduction ratio is displayed at the X enlargement/reduction ratio setting button.

② Input X enlargement/reduction ratio.

Input enlargement/reduction ratio with TEN key **0** to **9** **D**, or + or - key **↓** **↑** **E**. Press + or - key, and the value increases/decreases in increments of 0.01%.

When ENTER button **↵** **F** is pressed, the ratio is set at the inputted value, and the screen returns to the pattern reading screen.

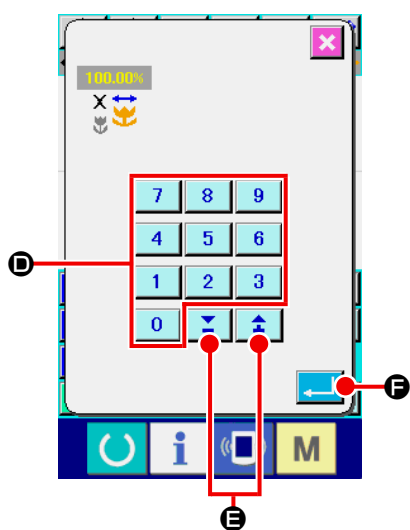

③ Set Y enlargement/reduction ratio.

When Y ENLARGEMENT/REDUCTION RATIO SETTING button **100.00%** **E** is pressed, the Y enlargement/reduction ratio setting screen is displayed. Setting procedure is the same as that of X enlargement/reduction ratio.

The set value of the present Y enlargement/reduction ratio is displayed at the Y enlargement/reduction ratio setting button.

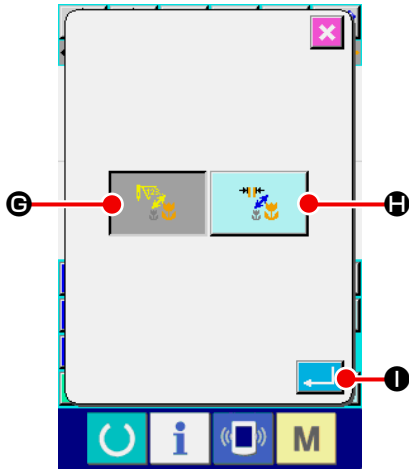

④ **Set the enlargement/reduction procedure.**



For the enlargement/reduction procedure, either stitch length increase/decrease or number of stitches increase/decrease can be selected.

When ENLARGEMENT/REDUCTION PROCEDURE

SELECTION button  G is pressed, the enlargement/

reduction procedure selection screen is displayed.

Enlargement/reduction procedure which is being selected now is displayed at the enlargement/reduction procedure selection button.

(Number of stitches increase/decrease , stitch length increase/decrease )

⑤ **Select the enlargement/reduction procedure.**

Select NUMBER OF STITCHES INCREASE/DECREASE



G or STITCH LENGTH INCREASE/DECREASE



H in the enlargement/reduction procedure selection

screen. The color of the selected button is changed



When ENTER button  I is pressed, the setting is

selected, and the screen returns to the pattern reading screen.



1. In case of the point sewing, enlargement/reduction can be performed by the stitch length increase/decrease even when the number of stitches increase/decrease is set by means of the enlargement/reduction procedure.
2. When X/Y enlargement/reduction ratio is individually set or X/Y enlargement/reduction is repeated in case of circle or arc, the shape may not be held since the sewing is changed to the point sewing, and enlargement/reduction is performed by the number of stitches enlargement/reduction.

(3) Set the kind of reading data

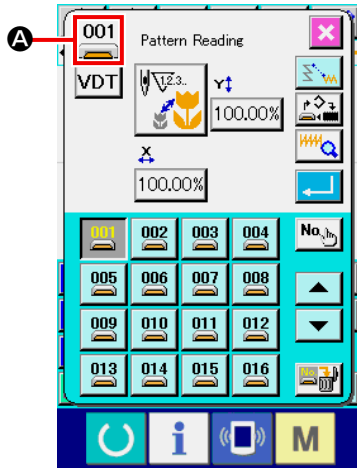

Object media to read the pattern data and the kind of pattern data can be selected.

It is possible to select the media below.

Media which is being selected now is displayed at section **A** with pictograph.

Object media	Pictograph
Sewing machine memory	
Media	

It is possible to select the data below.

Data format which is being selected is displayed at the kind of pattern selection button.

Kind of data	Button display	Corresponding media
Vector format data		
Sewing standard format data		
Writing style data (Data corresponding to AMS-B, C, and D series)		

• Folder structure of the media

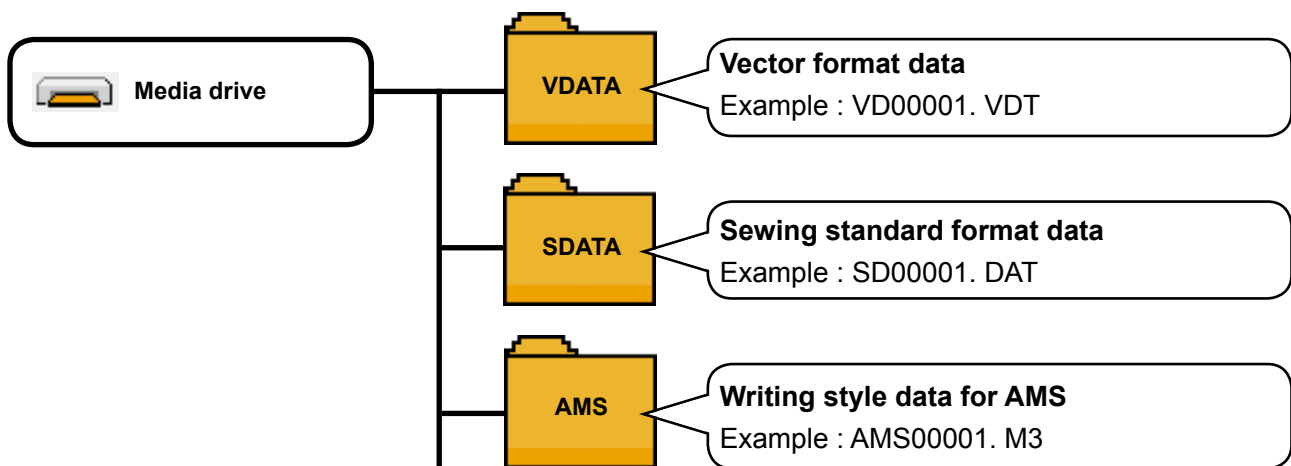

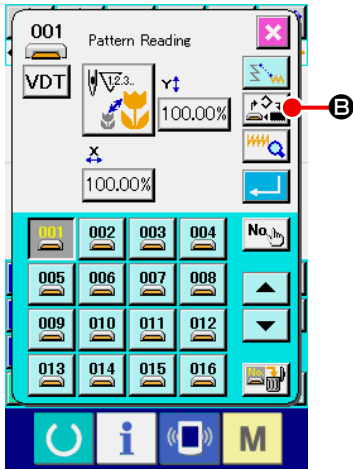



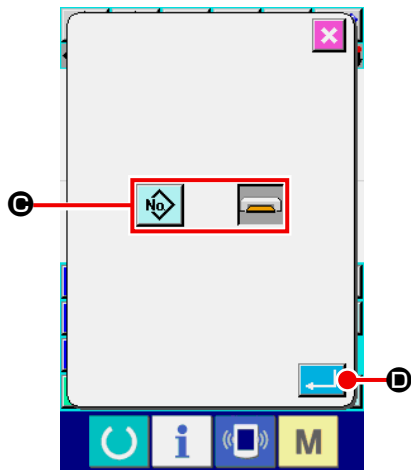

① **Set the object media.**

When OBJECT MEDIA SELECTION button  **E** is pressed, the object media setting screen is displayed.



Select the kind of media to read in from sewing machine memory  and media  of **C**.

The color of the selected button is changed .



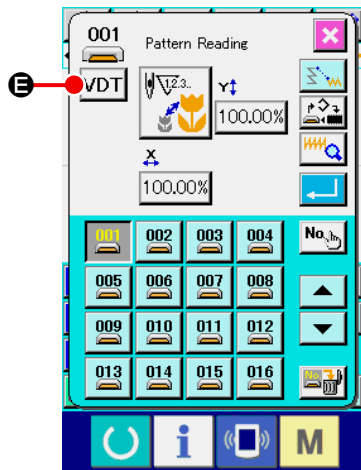

When ENTER button  **D** is pressed, the setting has been selected, and the screen returns to the pattern reading screen.

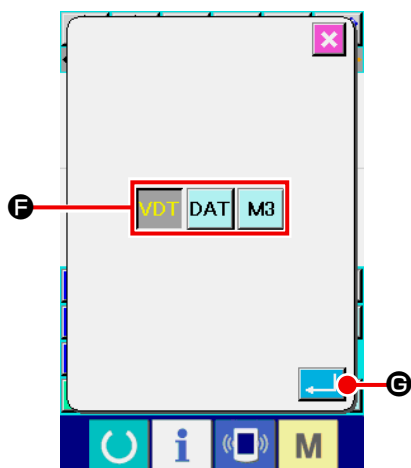

② **Set the kind of pattern.**

When KIND OF PATTERN SELECTION button  **E** is pressed, the kind of pattern setting screen is displayed.



Select the kind of pattern to read in from vector format , standard format , and writing style data  of **F**. The color of the selected button is changed .

When ENTER button  **G** is pressed, the setting has been selected, and the screen returns to the pattern reading screen.



Caution It may not be possible to select the kind of pattern depending on the object media.

6-5. Pattern writing

Pattern data is written.



Use the media which has been formatted with IP-420.

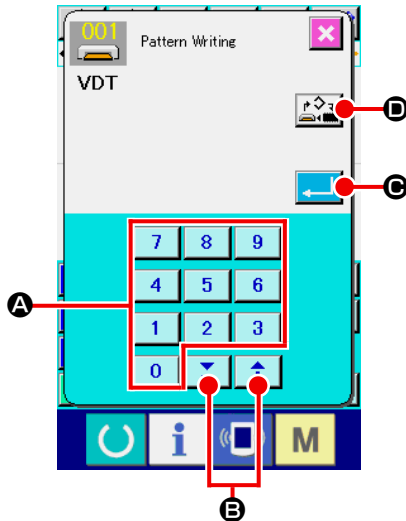

(1) Write the pattern data



① Select the pattern writing.



When PATTERN WRITING button  is pressed in the standard screen, the pattern writing screen is displayed.

② Specify the pattern No.

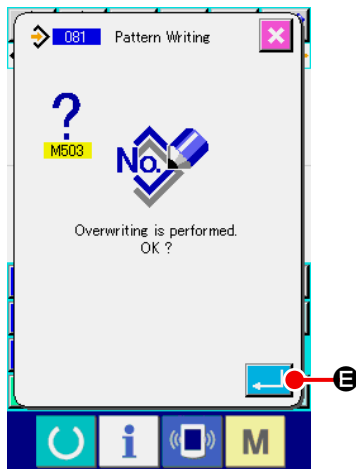
Specify the pattern No. of writing destination with TEN key  to  **A**, or + or - key  **B**. When + or - key is pressed, the No. which is open next is displayed.







③ Execute the pattern writing.

When ENTER button  **C** is pressed, the created pattern data is written to the inputted No., and the screen returns to the standard screen. When the pattern data of the specified pattern No. already exists, the overwriting confirmation screen is displayed, and the pattern writing is executed after pressing ENTER button  **E**.

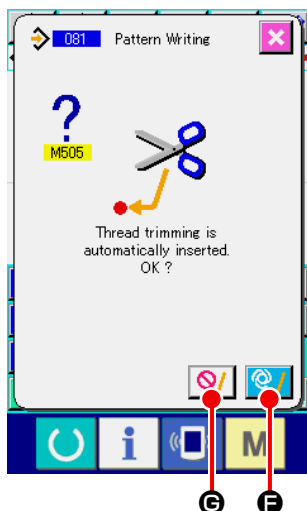
When OBJECT MEDIA SELECTION button  **D** is pressed, the object media setting screen is displayed, and the media to be the object of writing can be selected.

Setting procedure is the same as that of the pattern reading.



In the case where the thread trimming command does not exist in the termination of the pattern and before jump feed, the automatic thread trimming insertion confirmation screen is displayed after pressing ENTER button  **C**, and inserting thread trimming  **F** or not inserting  **G** can be selected.

When either button is pressed, the pattern writing is executed.

7. FORMATTING MEDIA (090)

Media is formatted.

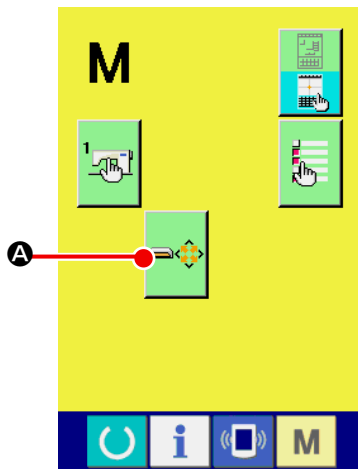

① Display the media format screen.

When MODE button **M** is pressed in the standard screen, the mode screen is displayed. Here press FORMAT button

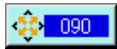

and the media format screen is displayed.

When FORMAT (function code 090)  is selected in the code list screen, the format screen can be selected as well.

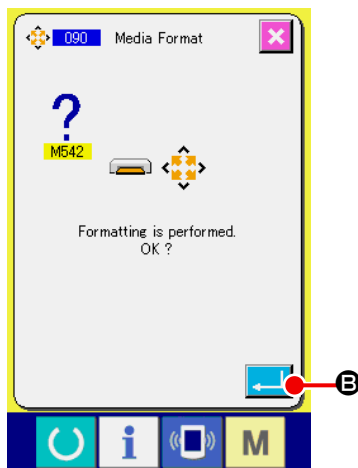

② Start formatting of the media.

Set the media you desire to format to the media slot, press ENTER button  **B** after closing the cover, and formatting starts.

When formatting ends, the screen returns to the mode screen.



When performing formatting, all data disappear. It is not possible to restore the data.

8. TRIAL SEWING

Confirm the shape or the like of the pattern created by using readout data or input function with trial sewing.

For the trial sewing, the screen and the item that can be set change according to the models.

Explanation below is the example in case of AMS-210EN.



Before performing the trial sewing, it is necessary to register the setting of the height of intermediate presser and that of the thread tension.

8-1. Preparing the trial sewing

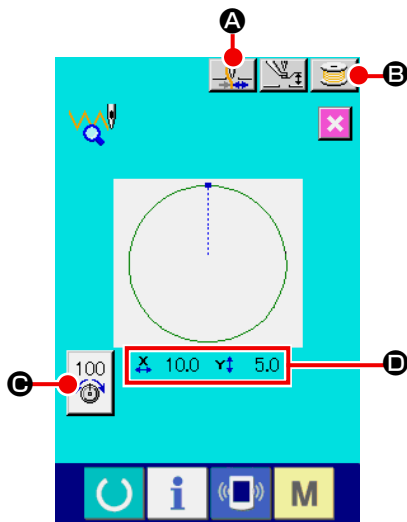

① Display the trial sewing screen.

Press SEWING PREPARATION button  to display the trial sewing preparation screen.

The sizes in X direction and Y direction are displayed in **D** section.

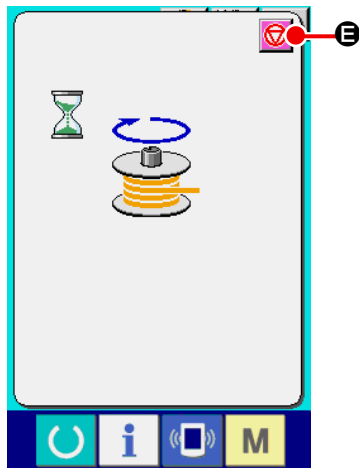

② Prepare the trial sewing.

(a) When thread clamp button  **A** is pressed, ON  / OFF  of thread clamp can be changed alternately.





(b) When BOBBIN WINDER button  **B** is pressed, the bobbin winder pop-up is displayed. When the pedal is depressed, the sewing machine rotates and bobbin winding starts.

When STOP button  **E** is pressed, the sewing machine stops, and the screen returns to the trial sewing preparation screen.

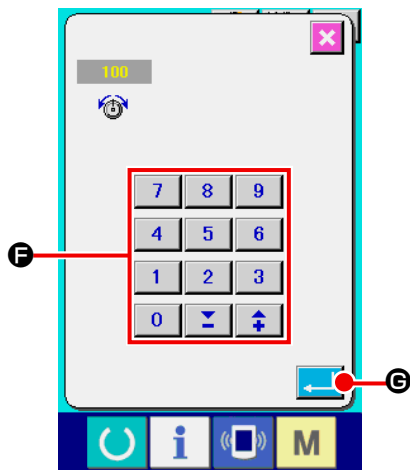





Bobbin winder cannot be selected unless the preparation of trial sewing is performed once.

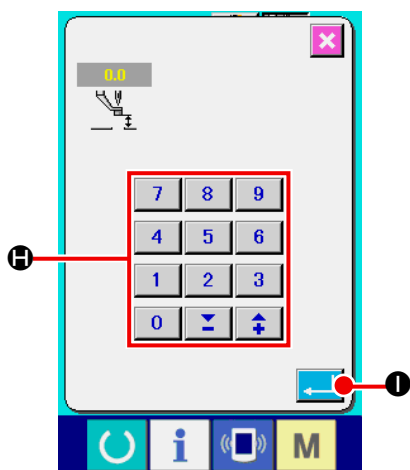



(c) When THREAD TENSION SETTING button  is pressed, the thread tension reference value setting pop-up is displayed. Input the value with TEN keys  to  and keys  **F**, determine the value with ENTER button  **G**, and return to the trial sewing preparation screen. The current set value is displayed in the thread tension setting button.

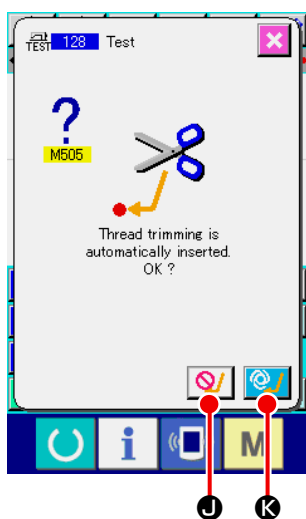

(d) When PRESSER HEIGHT SETTING button  is pressed, the intermediate presser reference value setting screen is displayed. Input the value with TEN keys  to  and keys  **H**, determine the value with ENTER button  **I**, and return to the trial sewing preparation screen.



In the case where the thread trimming command does not exist in the termination of pattern and before jump feed, the automatic thread trimming insertion confirmation screen is displayed after pressing SEWING PREPARATION button , and whether inserting thread trimming  **K** or not  **J** can be selected.

When either one of the buttons is pressed, the screen moves to the trial sewing preparation screen.

 **Caution**

1. When performing the trial sewing, input data is overwritten to the current pattern data of the sewing machine.
2. When the pattern was selected from the media or users' pattern was edited in the normal sewing mode, the data will disappear.

8-2. Performing the trial sewing

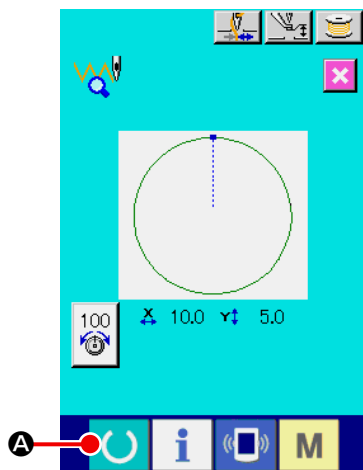

① Display the sewing screen of trial sewing.

When SEWING PREPARATION button  **A** is pressed, the sewing screen of trial sewing is displayed.

② Perform trial sewing.

Trial sewing can be performed with the normal sewing machine operation.

Sizes in X direction and Y direction are displayed in **H** section.

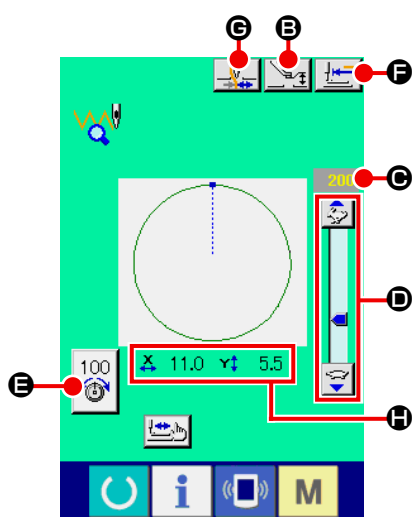



③ Perform setting of trial sewing.

(a) Display the intermediate presser height reference value setting screen with PRESSER HEIGHT SETTING button  **B**, and the same as the trial sewing preparation screen, the intermediate presser height reference value can be set.

(b) Speed is displayed in **C** section.

Speed can be set with SPEED VARIABLE RESISTOR

D. When RABBIT button  is pressed, speed is increased, and when TORTOISE button  is pressed, speed is decreased. When the bar section between them is pressed, speed can be directly specified.

(c) When THREAD TENSION SETTING button  **E** is pressed, the same as the trial sewing preparation screen, the thread tension reference value can be set.



(d) When START OF SEWING button  **F** is pressed, the presser can be returned to the position of the start of sewing.

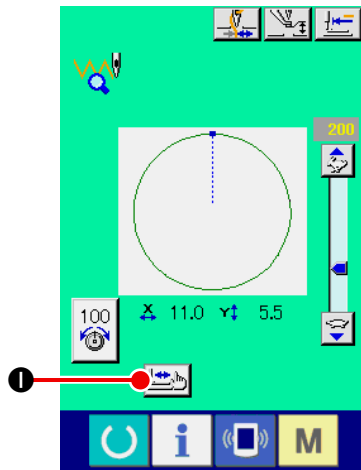

(e) ON/OFF of thread clamp can be changed over with THREAD CLAMP button  **G**.



④ Confirm the shape of pattern data.



When SHAPE CHECK button  **I** is pressed on the trial sewing preparation screen, the shape checking screen is displayed.







The current position is represented by , the sewing start position is represented by  and the sewing end position is represented by .

Check the sewing shape using ONE STITCH BACKWARD button  **J** and ONE STITCH FORWARD button  **K**.

When two or more commands have been input, the feed does not move but command display **L** is moved forward or backward.

When the button is held pressed long enough, the speed of travel increases.

When COMMAND SEARCH FORWARD button  **M** is pressed, the feed automatically moves to the sewing end position. When COMMAND SEARCH BACKWARD button  **N** is pressed, the feed automatically moves to the sewing start position.

To stop the feed before it reaches the sewing end/start position, press  **J**,  **K**,  **M**,  **N**,  **O** or  **P** button.

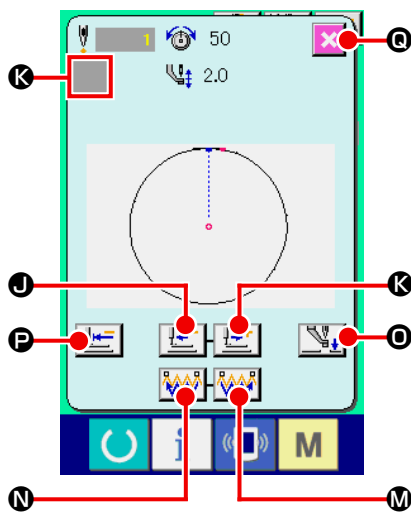

When the INTERMEDIATE PRESSER button  **O** is pressed, the intermediate presser is raised or lowered.

(This button is not displayed when MEMORY switch U103 is set at 0 (zero).)



<Shape checking screen>

⑤ Finishing the shape checking.

When PRESSER INITIAL POSITION button  **P** is pressed, the work clamp moves to the origin and the screen is restored to the trial sewing preparation screen. When CANCEL button  **Q** is pressed, the screen is restored to the trial sewing preparation screen.

9. SETTING FUNCTION

9-1. Comment input

Comment is set to the pattern data.

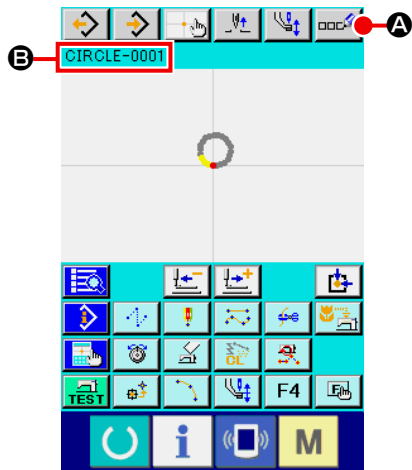

① Display the comment input screen.

Press COMMENT INPUT button  **A** in the standard screen. The comment input screen is displayed.





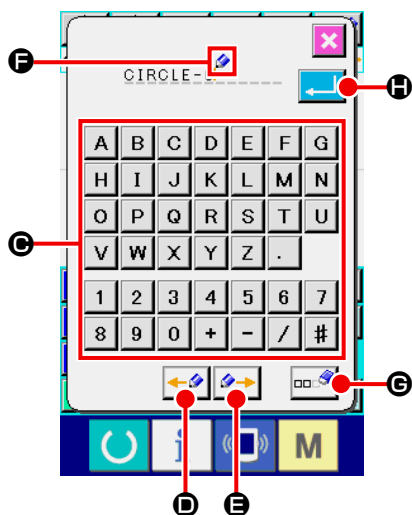

When the setting of pattern information display section is the comment display ("14. PERFORMING SETTING OF DISPLAY ④ Perform the item setting." p.106), the comment set to pattern information display section **B** is displayed.



② Input comment.

When each TEN key (**A** to **Z** , **0** to **9** , **+** , **/** , **-** , **#** , **.**) **C** is pressed, the character is inputted.





When " ← " button  **D** or " → " button  **E** is pressed, CURSOR  **F** moves in the direction. When TEN key is pressed at the position, the character is inserted to the position of the cursor. When DELETION button  **G** is pressed, the character located on the left-hand side of the cursor is deleted. As many as 255 characters can be inputted.

When ENTER button  **H** is pressed, the inputted comment becomes effective, and the screen returns to the standard screen.

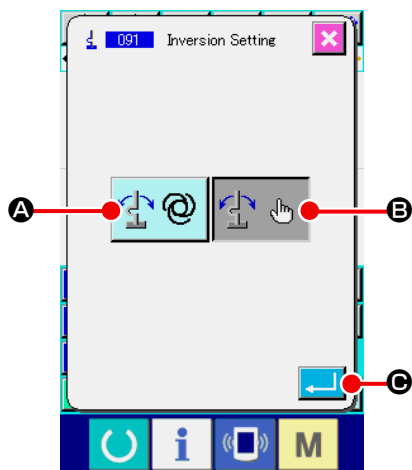
9-2. Clamp inversion setting (091)

Setting of clamp inversion is performed.



- ① **Display the inversion setting screen.**
Select and execute INVERSION SETTING (function code 091)  in the code list screen, and the inversion setting screen is displayed.
- ② **Select the inversion procedure.**
For the clamp inversion motion, select AUTOMATIC INVERSION  **A** or OPTIONAL INVERSION  **B**.
The color of the selected button is changed. When ENTER button  **C** is pressed, the selected setting becomes effective, and the screen returns to the standard screen.







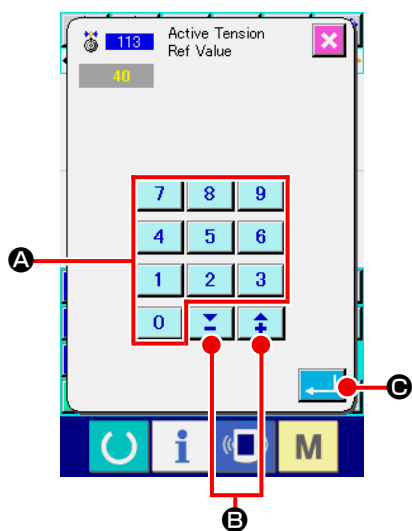

Setting of the clamp inversion can be performed only when the pattern is not inputted.

9-3. Thread tension reference value setting (113)

Thread tension reference value is set.



- ① **Display the thread tension reference value setting screen.**
Select and execute THREAD TENSION REFERENCE VALUE (function code 113)  in the code list screen, and the thread tension reference value setting screen is displayed.
- ② **Set the thread tension reference value.**
Directly input the value with TEN keys  to  **A**, or increase/decrease the value one by one with buttons  or  **B** in the thread tension reference value setting screen, and set the thread tension reference value.
When ENTER button  **C** is pressed, the set value is determined, and the screen returns to the standard screen.



When the thread tension reference value is changed, the tension of the whole pattern will change.

9-4. Intermediate presser height reference value setting (115)



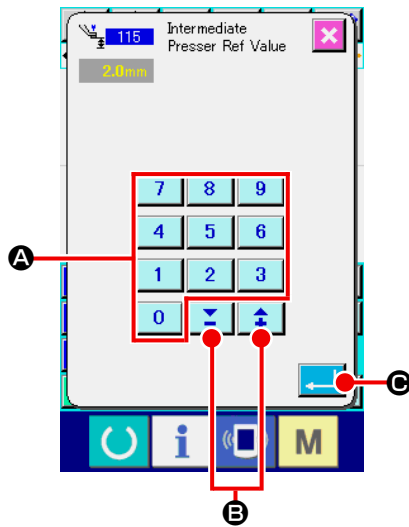

Intermediate presser height reference value is set.



① **Display the intermediate presser height reference value setting screen.**

Select and execute INTERMEDIATE PRESSER HEIGHT REFERENCE VALUE (function code 115)  in the code list screen, and the intermediate presser height reference value setting screen is displayed.

② **Set the intermediate presser height reference value.**

Directly input the value with TEN keys  to  **A**, or increase/decrease the value with + and - buttons  

B in the intermediate presser height reference value setting screen, and set the intermediate presser height reference value.

When ENTER button  **C** is pressed, the set value is determined, and the screen returns to the standard screen.





When the intermediate presser height reference value is changed, the intermediate presser height of the whole pattern will change.

10. SELECTING ENDING PROCEDURE (110)

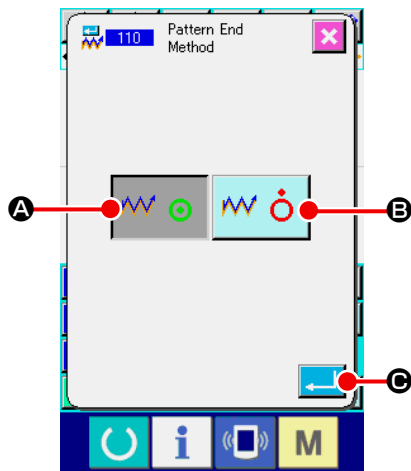
Setting of TRACE execution at the time of end of input is performed.



① **Display the ending procedure selection screen.**
Select and execute ENDING PROCEDURE SELECTION (function code 110)  in the code list screen, and the ending procedure selection screen is displayed.

② **Select the ending procedure.**
Select whether returning to the input start point one point by one point at the time of end of the graphic form input and performing the trace of the needle entry point of the created sewing element  A, or ending as it is  B. The color of selected button is changed.

When ENTER button  C is pressed, the selected setting is determined, and the screen returns to the standard screen.



When a circle is created, the presser moves to the last of the pattern even when the trace is not performed.

11. ALLOCATING FUNCTIONS TO F1 THROUGH F5 BUTTONS (112)

Functions are allocated to F buttons.
Initial display is as described below.

<Initial display screen>

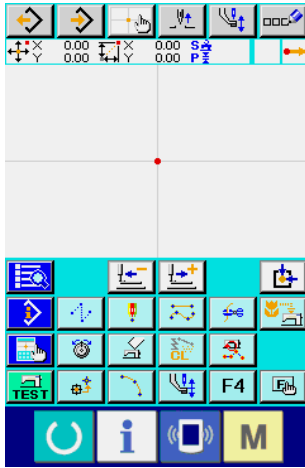

<AMS-E series>
<AMS-EN series>

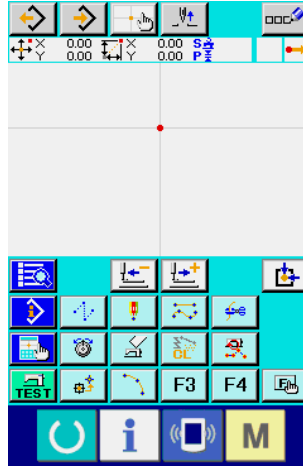

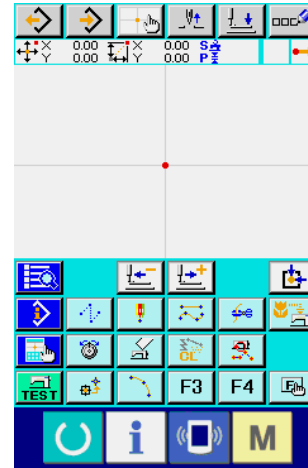

<LK-1900B series>



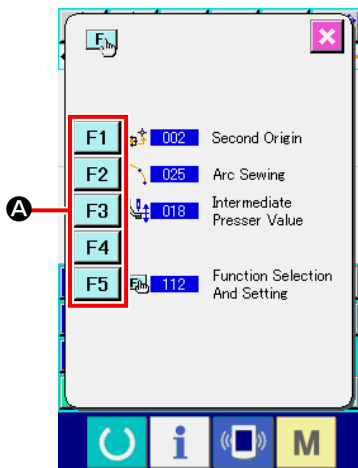



<AP series>

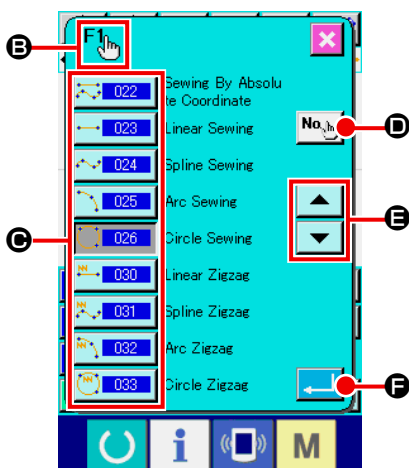

- ① **Display the function selection and setting screen.**
Select and execute FUNCTION SELECTION AND SETTING (function code 112)  in the code list screen, the function selection and setting screen is displayed.

- ② **Select the button to which function is allocated.**
Press the button you desire to allocate the function among F buttons  through  **A**, and the code list screen is displayed.
The number of selected F button is displayed in **B** section.



- ③ **Select the function to be allocated.**
Select the code No. of the function you desire to allocate F button from code list **C**, or press CODE INPUT button  **D** and input the code in the code input screen.
When UP/DOWN SCROLL button  or  **E** is pressed, the code list to be displayed can be changed over.
For the operating procedure of the function code selection, refer to **"2-3. Selection of function" p.10**.

When the function is selected and ENTER button  **F** is pressed, the screen returns to the function selection and setting screen.

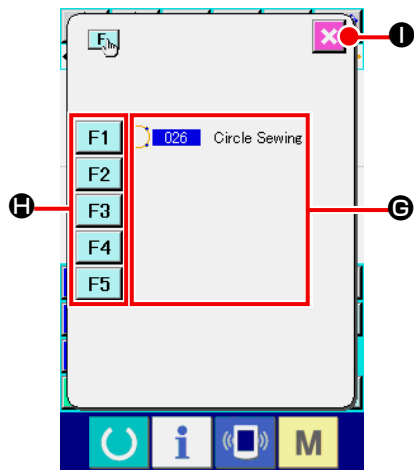

④ **Display of the allocated function.**

For the F button to which the function is allocated, the code of the allocated function is displayed in **G** section.

Here, press F buttons **F1** through **F5** **H**, and allocation to the next F button can be continued.

When CANCEL button **X** **I** is pressed, the screen returns to the standard screen.

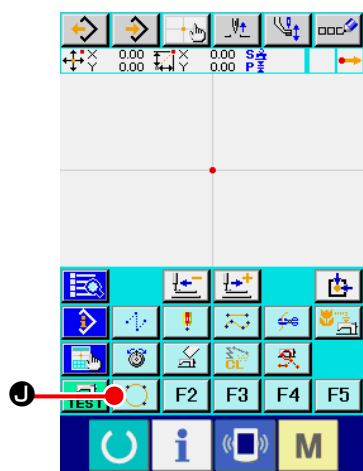

⑤ **Using F button.**

For the F button to which the function is allocated, as button



J, a pictograph to indicate the allocated function is displayed. When this button is pressed, the allocated function can be directly called.

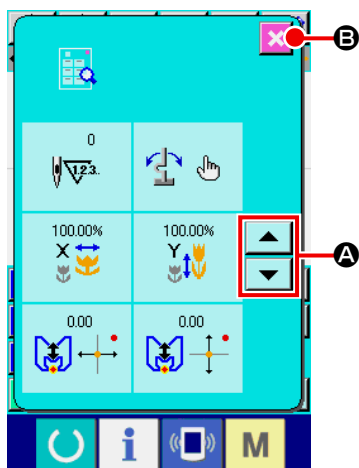

12. DISPLAYING DETAILED INFORMATION ON THE SET VALUE (093)

Setting contents of the pattern data can be confirmed.

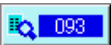

① Display the set value reference screen.



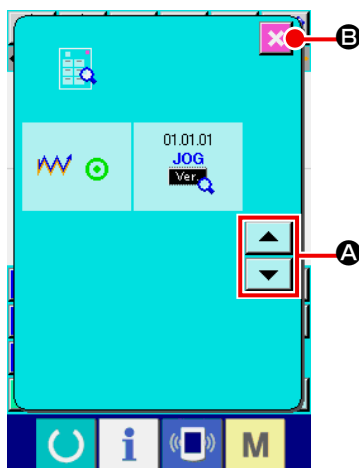

Select and execute SET VALUE REFERENCE (function code 093)  in the code list screen, and the set value reference screen is displayed.

Contents to be displayed can be changed over with UP/DOWN SCROLL buttons  and  **A**.

When CANCEL button  **B** is pressed, the screen returns to the standard screen.

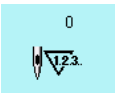
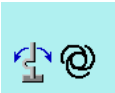
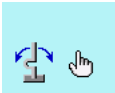

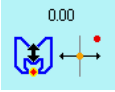
List of the display of contents in the set value reference screen

No.	Contents	Display
①	Total number of stitches	
②	Inversion setting	<div style="display: flex; justify-content: space-around;"> <div data-bbox="671 365 785 456">  <p data-bbox="612 472 829 499">Automatic inversion</p> </div> <div data-bbox="1094 365 1208 456">  <p data-bbox="1046 472 1244 499">Optional inversion</p> </div> </div>
③	X enlarging ratio	
④	Y enlarging ratio	
⑤	Enlarging/reducing reference point X coordinate	
⑥	Enlarging/reducing reference point Y coordinate	
⑦	Tracing setting	<div style="display: flex; justify-content: space-around;"> <div data-bbox="671 1021 785 1113">  <p data-bbox="679 1128 766 1155">Tracing</p> </div> <div data-bbox="1094 1021 1208 1113">  <p data-bbox="1062 1128 1228 1155">Without tracing</p> </div> </div>
⑧	JOG RVL	

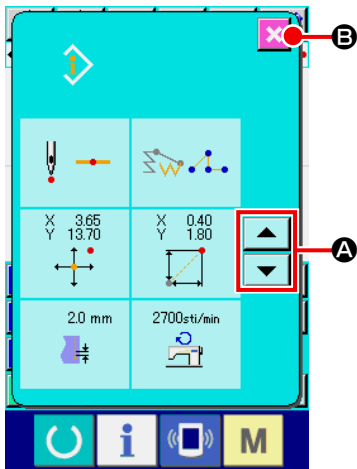

13. DISPLAYING DETAILED INFORMATION ON THE CURRENT NEEDLE POSITION

The detailed information on the current needle position can be confirmed.



① **Display the contents of pattern display screen.**







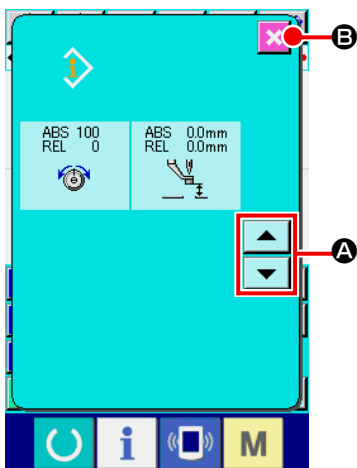

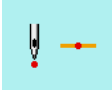

Press PATTERN CONTENTS DISPLAY button  in the standard screen, and the contents of pattern display screen is displayed.

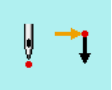
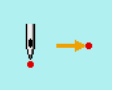
Contents to be displayed can be changed over with UP/DOWN SCROLL buttons  and  **A**.

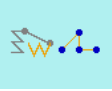
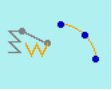
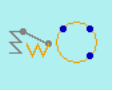
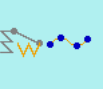
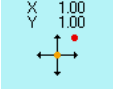
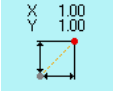
When CANCEL button  **B** is pressed, the screen returns to the standard screen.



List of the display of contents in the contents of pattern display screen

No.	Contents	Display					
①	Kind of needle entry of the current needle position is displayed.	 Head of pattern	 Midway of pattern	 Top	 End of element	 End of pattern	
②	Kind of element of the current needle position is displayed. In case of the mechanical control command, kind of command is displayed.	 Jump feed	 Point	 Polygonal	 Arc	 Circle	 Spline
③	Absolute coordinates of the current needle position is displayed.						
④	Relative coordinates of the current needle position is displayed.						
⑤	Pitch of element including the current needle position is displayed.						
⑥	Sewing speed or jump feed speed of the current needle position is displayed.	 Sewing speed	 Jump feed speed				
⑦	Thread tension (absolute value and relative value) of the current needle position is displayed.		Actual sewing machine motion becomes the value of ABS. “-” (minus) may be displayed according to the input order of reference value and set value. However, motion with the sewing machine becomes “0”.				
⑧	Intermediate presser height of the current needle position is displayed.		Actual sewing machine motion becomes the value of ABS. “-” (minus) may be displayed according to the input order of reference value and set value. However, motion with the sewing machine becomes “0”. * This is not displayed for the LK-1900B series.				

14. PERFORMING SETTING OF DISPLAY

Setting of the displaying procedure of the screen is performed.

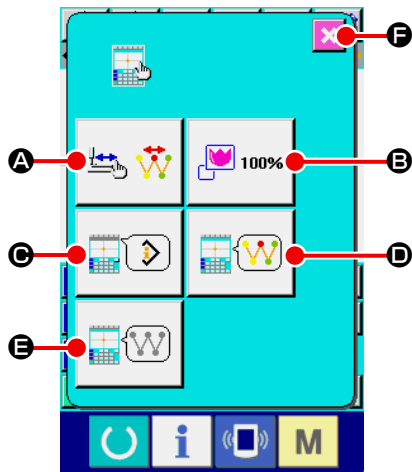

① Display the display setting screen.



When DISPLAY SETTING button  is pressed in the standard screen, the display setting screen is displayed.

When pressing buttons of **A**, **B**, **C**, **D** and **E**, the screen that sets the displaying procedure is displayed. Display setting contents being selected at present is displayed in each button.

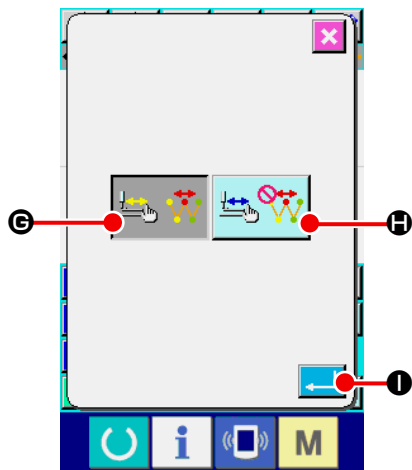
When CANCEL button  **F** is pressed, the screen returns to the standard screen.



② Perform Setting of the display update setting.

Press DISPLAY UPDATE SETTING button  **A** in the display setting screen. The display update setting screen is displayed. Whether updating the contents of display 

G or not updating  **H** at the time of tracing can be selected. The color of the selected button is changed.

When ENTER button  **I** is pressed, the screen returns to the display setting screen and the set contents can be reflected.

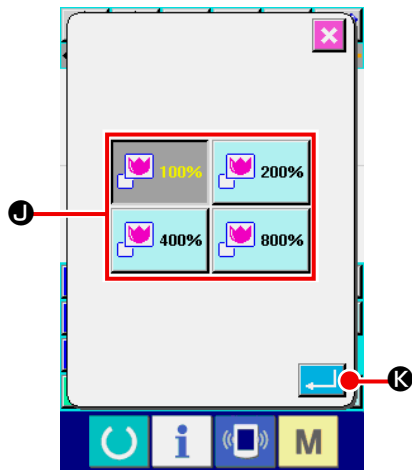



③ Perform the zoom setting.

Press ZOOM SETTING button  **E** in the display

setting screen. The zoom setting screen is displayed.

Select the magnification you desire to display from ZOOM

AMOUNT button  **J**. The color of the selected button

is changed . When ENTER button  **K** is pressed, the screen returns to the display setting screen and the set contents can be reflected.



In case of 100% display, the display is enlarged/reduced so that all of the sewing possible region can be displayed to the pattern display region.

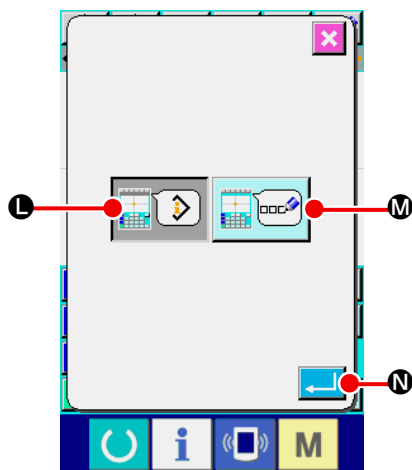

④ Perform the item setting.

Press ITEM SETTING button  **C** in the display setting

screen. The contents to be displayed in the information display section of the pattern can be selected from CURRENT POINT

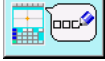
INFORMATION  **L** and COMMENT  **M** of the pattern. The color of the selected button is changed.

When ENTER button  **N** is pressed, the screen returns to the display setting screen and the set contents can be reflected.

Information display

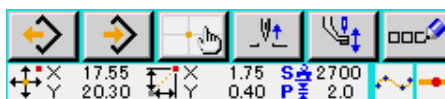

Comment display





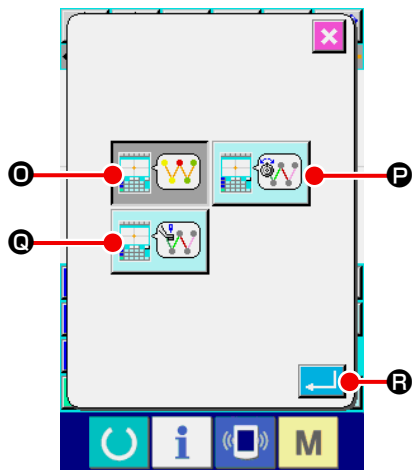

1. Characters that cannot be inputted with the sewing machine are displayed with * (asterisk).
2. Number of characters that can be displayed is limited to the right-hand end of the screen. Even when the number of characters is inputted more than the limit, it is not displayed.

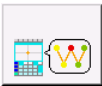

⑤ Performing the selection of the display color.



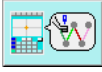

Press DISPLAY COLOR SELECTION button  **D** in the display setting screen. The display color selection screen is displayed.

The color display of the pattern can be selected from color displaying only at the current point  **O**, displaying color of the line with tension value  **P** and displaying











with the intermediate presser height set value  **Q**. The color of the selected button is changed. When ENTER button  **R** is pressed, the screen returns to the display setting screen and the set contents can be reflected.

* For LK-1900B series, the display button is not displayed with the intermediate presser height set value.

Color display according to the current point

Kind of point	Display color
Current point	 : Red
3 stitches in the direction of sewing start	 : Yellow
3 stitches in the direction of sewing end	 : Yellow-green
Others	 : Gray

Color display of the line according to tension value and intermediate presser height

Display color	Thread tension value	Intermediate presser height
	0 to 20	0 to 7
	21 to 40	8 to 14
	41 to 60	16 to 21
	61 to 80	22 to 28
	81 to 100	29 to 35
	101 to 120	36 to 42
	121 to 140	43 to 49
	141 to 160	50 to 56
	161 to 180	57 to 63
	181 to 200	64 to 70

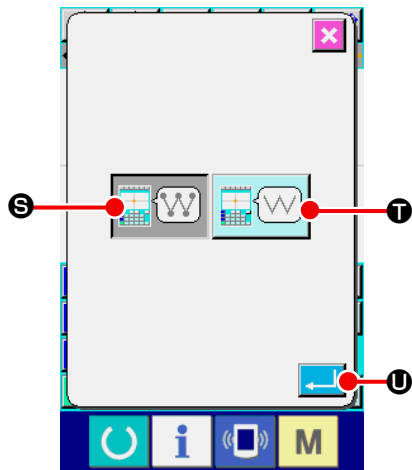

⑥ **Perform setting of the needle entry point display.**

Press NEEDLE ENTRY POINT DISPLAY SETTING button



Ⓔ in the display setting screen. The needle entry point display setting screen is displayed.

Displaying all needle entry points Ⓔ, and displaying 3 points of current, before and after, and top and end only of the pattern Ⓙ can be selected. The color of the selected

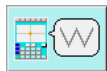

button is changed. When ENTER button Ⓚ is pressed, the screen returns to the display setting screen and the set contents can be reflected.

15. ELEMENT FORWARD/BACKWARD (130 and 131)

Current needle position can be moved before and after in the unit of element.

① Select the element forward.

Select and execute ELEMENT FORWARD (function code 130)  in the code list screen, and the element moves to the last position of the element including the current needle position. In case of the last position, the element moves to the last position of the next element.

② Select the element backward.

Select and execute ELEMENT BACKWARD (function code 131)  in the code list screen, the element moves to the top position of the element including the current needle position. In case of the top position, the element moves to the top position of the previous element.



Moving between the respective elements is performed linearly. When there is any obstacle on the way, interference occurs. So, be careful.

16. DIRECT INSTRUCTIONS BY TOUCHING THE SCREEN

The position to input can be directly instructed in the screen in case of creation or modification of the pattern.

For the coordinate direct instructions, there are the coordinate instructions screen, and the needle entry and shape point instructions screen according to the contents of instructions.

16-1. Coordinate direct instructions

Coordinate can be directly instructed by touching the screen.

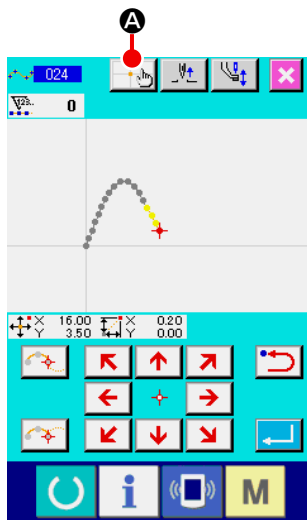

① **Display the coordinate instructions screen.**

When COORDINATE INSTRUCTIONS button  **A** is pressed in the screen to specify the position such as the specifying position of the sewing pattern screen, the specifying position of the point move screen, the specifying position of the point addition, etc., the coordinate instructions screen is displayed.

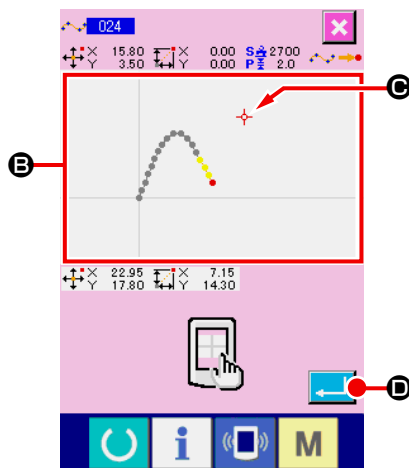

② **Instruct the coordinate.**

When PATTERN DISPLAY REGION **B** is pressed in the coordinate instructions screen, the pressed position is selected. CROSS CURSOR  **C** is played in the current selection position.

③ **Determine the coordinate.**

Adjust the cursor to the coordinate you desire to move, and press ENTER button  **D** to display the presser move confirmation screen.

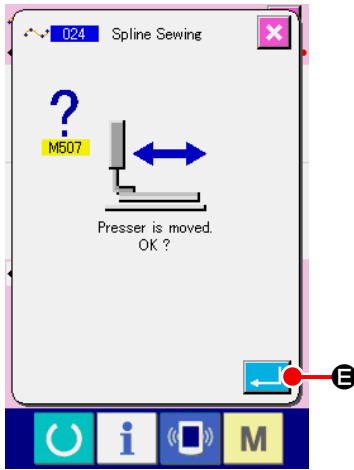

④ **Move the presser.**

When ENTER button  is pressed in the presser move confirmation screen, the presser moves to the position instructed with the cross cursor, and the screen returns to the specifying position screen.



The presser moves linearly. When there is any obstacle on the way, the presser interferes with it. So, be careful.

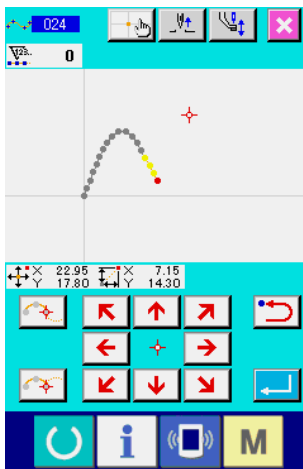

16-2. Needle entry/shape points direct instructions

Needle entry/shape points can be directly selected.

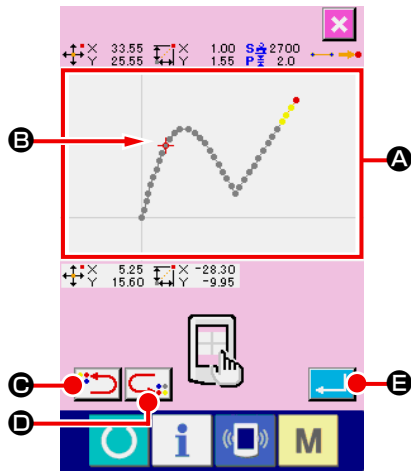



① Display the needle entry/shape points instructions screen.

When COORDINATE INSTRUCTIONS button  is pressed in the screen specifying needle entry/shape points such as the standard screen, the shape point specifying screen, etc., the needle entry/shape points instructions screen is displayed.

② Instruct the coordinate.



When PATTERN DISPLAY REGION **A** is pressed in the coordinate instructions screen, the pressed position is selected. CROSS CURSOR  **B** is displayed in the current selection position.

③ Instruct the needle entry/shape points.

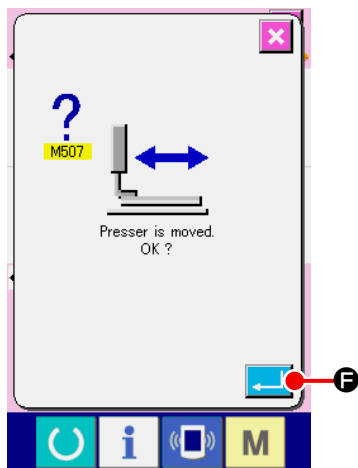
When NEXT CANDIDATE RETRIEVAL key  **C** or PREVIOUS CANDIDATE RETRIEVAL key  **D** is pressed, the needle entry near the cross cursor is retrieved, and the next or the previous candidate is set to the selected state.



④ Determine the entry/shape points.

When ENTER button  **E** is pressed, the presser move confirmation screen is displayed. Here, when ENTER button  **F** is pressed, the presser moves to the position specified with the cross cursor, and the screen returns to the specifying position screen in the state that needle/shape points are selected.

When the needle entry point is not selected, ENTER button  **E** becomes invalid.



The presser moves linearly. When there is any obstacle on the way, the presser interferes with it. So, be careful.

17. PERFORMING SETTING OF THE MEMORY SWITCH DATA

17-1. Setting of the memory switch data is performed

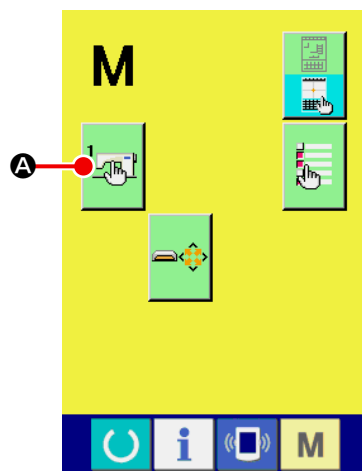

- ① **Display the memory switch setting screen.**

Press MODE button  in the standard screen to display the mode screen.

- ② **Display the memory switch data list screen.**

When MEMORY SWITCH button  **A** is pressed, the memory switch data list screen is displayed.

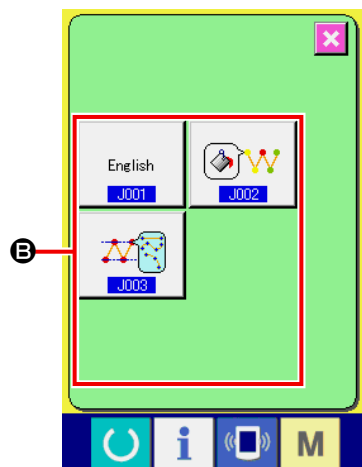

- ③ **Select the memory switch to be set.**

Data item buttons of the memory switch that can be set is displayed at **B**. Press the data item button you desire to change.

17-2. Change over the display language

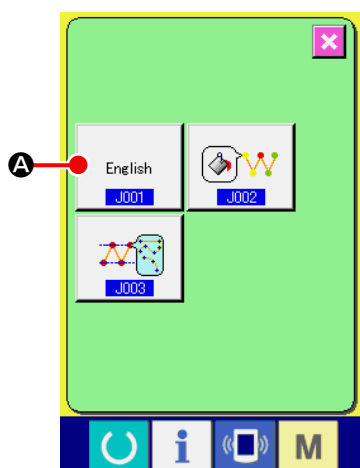

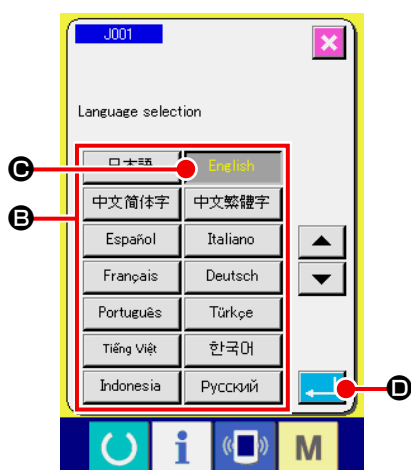

① Display the language selection screen.

When LANGUAGE SELECTION button  **A** is pressed in the memory switch list screen, the language selection screen is displayed. Language being selected at present is displayed in the language selection button.

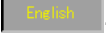

② Select the language.

Language button list of the languages that can be displayed is displayed at **B**. Select LANGUAGE button  **C** of the language you desire to display. The color of the selected language button is changed . When the language is selected and ENTER button  **D** is pressed, the screen returns to the memory switch list screen, and the display language is changed over.

Selection of the language is common to the language setting of the normal sewing mode. When setting is changed, the language of the normal sewing mode will change.

17-3. Changing the display color of the current point

It is possible to change the display color of the needle entry point and the current point of the shape point.

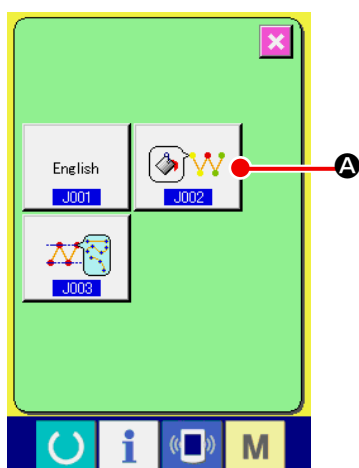



① Display the display color selection screen.

When CURRENT POINT DISPLAY COLOR SELECTION

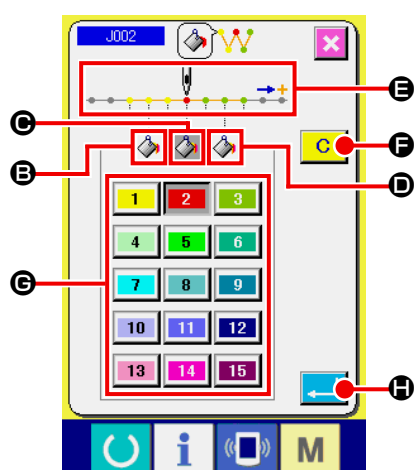
button  **A** is pressed in the memory switch list screen, the display color selection screen is displayed.



② Select the point where the display color is desired to be changed.

When any button among  **B**, **C** and **D** of the point where the display color is desired to be changed is pressed, the pressed button  changes the color and the button of the color which is currently selected at section **C** changes the color .



B : 3 stitches in the direction of the start of sewing Initial color 

C : Current point Initial color 

D : 3 stitches in the direction of the end of sewing Initial color 

③ Select the display color.

When the button of the color to be displayed is pressed

from among  **1** to  **15** at section **C**, the pressed button changes the color, and the color becomes the display color of the point which is selected at section **E**.

When ENTER button  **H** is pressed, the screen returns to the memory switch list screen and the setting is reflected.

When CLEAR button  **F** is pressed, the colors of all points return to the initial values.

17-4. Setting the zigzag sewing output method

When sewing data is to be written on a medium or carrying out trial sewing, the method to output zigzag sewing included in a pattern can be selected.

When reading data onto the sewing machine model or PM-1 which does not support zigzag sewing to be sewn with the sewing start position set at the "end" of stitch base line, output the zigzag sewing data converted to the point sewing data.

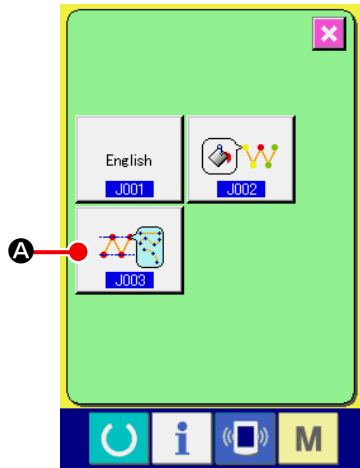

① Displaying the zigzag sewing output method select screen.

When ZIGZAG SEWING OUTPUT METHOD SELECT button

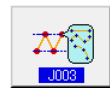

Ⓐ is pressed on the MEMORY switch list screen, the zigzag sewing output method select screen is displayed.

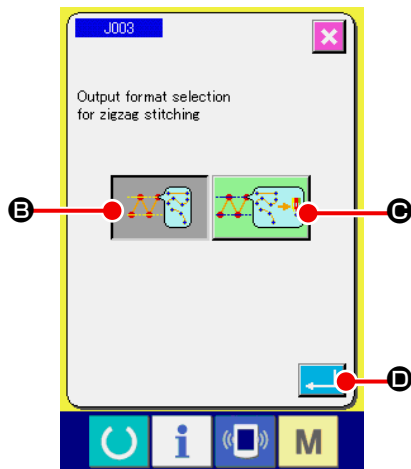

② Selecting the zigzag sewing output method.

The zigzag sewing output method is displayed. Select

OUTPUT WITH ZIGZAG SHAPE KEPT  Ⓑ or

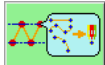
OUTPUT WITH ZIGZAG SHAPE CONVERTED TO POINT SHAPE  Ⓒ.

The selected OUTPUT METHOD SELECT button is displayed in reverse video.

When the output method is selected and EXECUTE button



Ⓓ is pressed, the screen is restored to the MEMORY switch list screen.

18. SELECTING THE FUNCTION CODE TO BE DISPLAYED

The function code to be displayed can be selected in the code list screen.

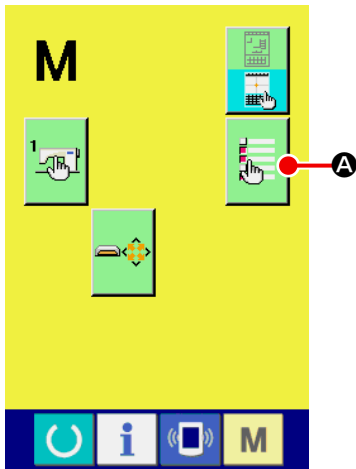



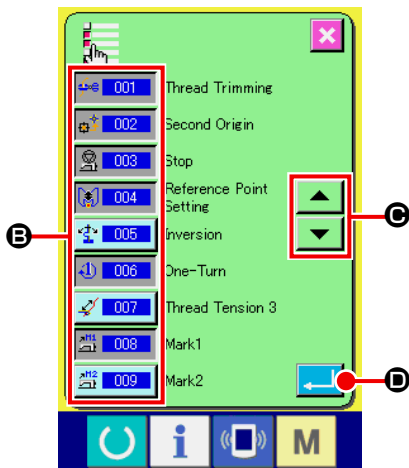

① Display the code list display selection screen.

When CODE LIST DISPLAY SELECTION button  **A** is pressed in the mode screen of the body input mode, the code list display selection screen is displayed.

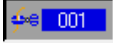

② Select the function code to be displayed.

Function code buttons are displayed at section **B** of the code list display selection screen. When the function code button is pressed, “Display”  (color is changed) and “Not display”  in the code list screen are changed over alternately. The display contents of **B** can be scrolled with SCROLL buttons  and  **C**.

When ENTER button  **D** is pressed, the screen returns to the mode screen and the selected contents can be reflected.

19. FUNCTION CODE LIST

Function codes are described in the list below.



Function code list	Remarks
 001 Thread Trimming	Thread trimming command is inputted.
 002 Second Origin	2nd origin is set.
 003 Stop	Stop command is inputted.
 004 Reference Point Setting	Reference point to perform enlarging/reducing is set.
 005 Inversion	Clamp inversion command is inputted.
 006 One-Turn	Sewing machine one revolution is inputted.
 007 Thread Tension 3	ON/OFF of thread tension controller No. 3 is performed.
 008 Mark1	Mark 1 is created.
 009 Mark2	Mark 2 is created.
 010 Delay	Delay command is inputted.
 011 External Input	Waiting for the signal from external device is performed.
 012 External Output	Signal is output to external device.
013	
 014 Active Tension Value	Thread tension value is set.
015	





Function code list		Remarks
 016	Area Classification	Area classification command is inputted.
	017	
 018	Intermediate Presser Value	Intermediate presser height is set. * For LK-1900B series, it is not possible to select.
 019	Sewing Machine Stop	Sewing machine stop command is inputted.
 020	Jump	Sewing data of jump feed is created.
 021	Point Sewing	Sewing data of point sewing is created.
 022	Sewing By Absolute Coordinate	Sewing data of linear line and curve is created.
 023	Linear Sewing	Sewing data of linear line is created.
 024	Spline Sewing	Sewing data of spline curve is created.
 025	Arc Sewing	Sewing data of arc is created.
 026	Circle Sewing	Sewing data of circle is created.
	027	
	028	
	029	
 030	Linear Zigzag	Sewing data of linear zigzag sewing is created.
 031	Spline Zigzag	Sewing data of spline zigzag sewing is created.
 032	Arc Zigzag	Sewing data of arc zigzag sewing is created.
 033	Circle Zigzag	Sewing data of circle zigzag sewing is created.





Function code list		Remarks
 034	Linear Offset	Sewing data of linear offset sewing is created.
 035	Spline Offset	Sewing data of spline offset sewing is created.
 036	Arc Offset	Sewing data of arc offset sewing is created.
 037	Circle Offset	Sewing data of circle offset sewing is created.
	038	
	039	
 040	Linear 2Normal-Feed	Sewing data of linear double orderly sewing is created.
 041	Spline 2Normal-Feed	Sewing data of spline double orderly sewing is created.
 042	Arc 2Normal-Feed	Sewing data of arc double orderly sewing is created.
 043	Circle 2Normal-Feed	Sewing data of circle double orderly sewing is created.
 044	Linear 2Reverse-Feed	Sewing data of linear double reverse sewing is created.
 045	Spline 2Reverse-Feed	Sewing data of linear double reverse sewing is created.
 046	Arc 2Reverse-Feed	Sewing data of spline double reverse sewing is created.
 047	Circle 2Reverse-Feed	Sewing data of circle double reverse sewing is created.
	048	
	049	
 050	Linear overlapped Reverse	Sewing data of linear overlapped reverse sewing is created.
 051	Spline overlapped Reverse	Sewing data of spline overlapped reverse sewing is created.

Function code list		Remarks
 052	Arc overlapped Reverse	Sewing data of arc overlapped reverse sewing is created.
 053	Circle overlapped Reverse	Sewing data of circle overlapped reverse sewing is created.
	054	
	055	
	056	
	057	
	058	
 059	Machine Control Command Deletion	Mechanical control command is deleted.
 060	Jump Speed Change	Speed of the created jump feed data is changed.
 061	Sewing Speed Section Change	Speed of the created sewing data is changed.
 062	Stitching Pitch Change	Stitch length of the created sewing data is changed.
 063	Element Deletion	Created data is deleted in element unit.
 064	Back-Tack	Back-tack data is created.
 065	Condensation	Condensation sewing data is created.
 066	Overlap Stitch	Overlapped sewing data is created.
	067	
	068	
	069	

Function code list		Remarks
 070	Point Deletion Relative	Needle entry point is deleted and rear data moves.
 071	Point Movement Relative	Needle entry point is moved and rear data moves.
 072	Linear Apex Deletion Relative	Vertex of linear line is deleted and rear data moves.
 073	Linear Apex Movement Relative	Vertex of linear line is moved and rear data moves.
 074	Point Deletion Absolute	Needle entry point is deleted and rear data does not move.
 075	Point Movement Absolute	Needle entry point is moved and rear data does not move.
 076	Point Addition Absolute	Needle entry point is added and rear data does not move.
 077	Linear Apex Deletion Absolute	Vertex of linear line is deleted and rear data does not move.
 078	Linear Apex Movement Absolute	Vertex of linear line is moved and rear data does not move.
	079	
	080	
	081	
 082	X-axis Symmetry	Pattern symmetrical to X-axis of needle position is added.
 083	Y-axis Symmetry	Pattern symmetrical to Y-axis of needle position is added.
 084	Point Symmetry	Pattern which is point symmetry in terms of the center of needle position is added.
 085	Pattern Movement	Position of sewing pattern is moved.
 086	Pattern Copy	Sewing pattern is copied.
 087	Pattern Deletion	Pattern data is erased.

Function code list	Remarks
088	
089	
 090 Media Format	Media is formatted.
 091 Inversion Setting	Setting of clamp inversion is performed.
 092 Sewing Speed	Sewing speed is inputted.
 093 Value Reference	Set value of pattern data is displayed.
094	
095	
096	
097	
 098 Y Mirror Order	Current needle position is taken as the reference, and orderly sewing pattern of Y symmetry is created.
099	
100	
101	
102	
103	
104	
105	

Function code list	Remarks
106	
107	
108	
 109 Input Function Code	Function code is inputted.
 110 Pattern End Method	Tracing/not tracing of data at the time of end/execution is set.
111	
 112 Function Selection And Setting	Function is allocated to F button.
 113 Active Tension Ref Value	Thread tension reference value is set.
114	
 115 Intermediate Presser Ref Value	Intermediate presser height reference value is set. * For LK-1900B series, it is not possible to select.
116	
117	
118	
119	
120	
121	
122	
123	

Function code list	Remarks
124	
125	
126	
127	
128	
129	
 130 Element Forward	Element moves to the last position of element including current needle position. In case of the last position, it moves to the last position of the next element.
 131 Element Backward	Element moves to the top position of element including current needle position. In case of the top position, it moves to the top position of the previous element.
132	
133	
134	
 135 Configuration Point Addition	Shape point is added.
 136 Configuration Point Move	Shape point is moved.
 137 Configuration Point Deletion	Shape point is deleted.
138	
139	
140	
141	

20. SETTING RANGE LIST

<AMS-E series>

Item	Min. value	Max. value	Initial value	Increase/decrease unit.
Ordinary sewing pitch	0.1 mm	12.7 mm	2.0 mm	0.1 mm
Offset sewing pitch	0.1 mm	12.7 mm	2.0 mm	0.1 mm
Zigzag sewing pitch	0.1 mm	12.7 mm	2.0 mm	0.1 mm
Reverse sewing pitch	0.1 mm	12.7 mm	2.0 mm	0.1 mm
Zigzag width	0.1 mm	10.0 mm	3.0 mm	0.1 mm
Offset width	0.1 mm	99.9 mm	1.0 mm	0.1 mm
Double orderly sewing width	0.1 mm	99.9 mm	10.0 mm	0.1 mm
Double reverse sewing width	0.1 mm	99.9 mm	10.0 mm	0.1 mm
Jump feed speed	10 mm/s	500 mm/s	500 mm/s	10 mm/s
Sewing speed	200 sti/min	2700 sti/min*1	2700 sti/min*1	100 sti/min
Media pattern No.	1	999	1	1
Sewing machine memory No.	1	200	1	1
X direction enlargement/reduction ratio	1.00%	400.00%	100.00%	0.01%
Y direction enlargement/reduction ratio	1.00%	400.00%	100.00%	0.01%
External input terminal No.	0	15	0	1
External output terminal No.	0	15	0	1
Delay	0 msec	3100 msec	100 msec	100 msec
Number of stitches at the start of sewing (Automatic back-tack, condensation sewing)	0	9	0	1
Number of stitches at the end of sewing (Automatic back-tack, condensation sewing)	0	9	0	1
Intermediate presser height setting	0.0 mm	7.0 mm	0.0 mm	0.1 mm
Thread tension setting	0	200	100	1
Thread tension reference value	0	200	100	1
Intermediate presser height reference value	0.0 mm	7.0 mm	0.0 mm	0.1 mm
Function No.	0	137	0	1

* 1 : For AMS-224E, max. sewing speed value and the initial value are 2,500 sti/min.

<AMS-EN series>

Item	Min. value	Max. value	Initial value	Increase/decrease unit.
Ordinary sewing pitch	0.1 mm	12.7 mm	2.0 mm	0.1 mm
Offset sewing pitch	0.1 mm	12.7 mm	2.0 mm	0.1 mm
Zigzag sewing pitch	0.1 mm	12.7 mm	2.0 mm	0.1 mm
Reverse sewing pitch	0.1 mm	12.7 mm	2.0 mm	0.1 mm
Zigzag width	0.1 mm	10.0 mm	3.0 mm	0.1 mm
Offset width	0.1 mm	99.9 mm	1.0 mm	0.1 mm
Double orderly sewing width	0.1 mm	99.9 mm	10.0 mm	0.1 mm
Double reverse sewing width	0.1 mm	99.9 mm	10.0 mm	0.1 mm
Jump feed speed	10 mm/s	500 mm/s	500 mm/s	10 mm/s
Sewing speed	200 sti/min	2800 sti/min*1	2800 sti/min*1	100 sti/min
Media pattern No.	1	999	1	1
Sewing machine memory No.	1	999	1	1
X direction enlargement/reduction ratio	1.00%	400.00%	100.00%	0.01%
Y direction enlargement/reduction ratio	1.00%	400.00%	100.00%	0.01%
External input terminal No.	0	15	0	1
External output terminal No.	0	15	0	1
Delay	0 msec	3100 msec	100 msec	100 msec
Number of stitches at the start of sewing (Automatic back-tack, condensation sewing)	0	9	0	1
Number of stitches at the end of sewing (Automatic back-tack, condensation sewing)	0	9	0	1
Intermediate presser height setting	0.0 mm	7.0 mm	0.0 mm	0.1 mm
Thread tension setting	0	200	100	1
Thread tension reference value	0	200	100	1
Intermediate presser height reference value	0.0 mm	7.0 mm	0.0 mm	0.1 mm
Function No.	0	137	0	1

* 1 : For AMS-224EN4530, 6030, max. sewing speed value and the initial value are 2,500 sti/min.
For AMS-224EN6060, max. sewing speed value and the initial value are 2,000 sti/min.

<LK-1900B series>

Item	Min. value	Max. value	Initial value	Increase/decrease unit.
Ordinary sewing pitch	0.1 mm	10.0 mm	2.0 mm	0.1 mm
Offset sewing pitch	0.1 mm	10.0 mm	2.0 mm	0.1 mm
Zigzag sewing pitch	0.1 mm	10.0 mm	2.0 mm	0.1 mm
Reverse sewing pitch	0.1 mm	10.0 mm	2.0 mm	0.1 mm
Zigzag width	0.1 mm	10.0 mm	3.0 mm	0.1 mm
Offset width	0.1 mm	99.9 mm	1.0 mm	0.1 mm
Double orderly sewing width	0.1 mm	99.9 mm	10.0 mm	0.1 mm
Double reverse sewing width	0.1 mm	99.9 mm	10.0 mm	0.1 mm
Jump feed speed	10 mm/s	500 mm/s	500 mm/s	10 mm/s
Sewing speed	400 sti/min	3200 sti/min ^{*1}	3200 sti/min ^{*1}	100 sti/min
Media pattern No.	1	999	1	1
Sewing machine memory No.	1	200	1	1
X direction enlargement/reduction ratio	20.00%	200.00%	100.00%	0.01%
Y direction enlargement/reduction ratio	20.00%	200.00%	100.00%	0.01%
External input terminal No.	0	15	0	1
External output terminal No.	0	15	0	1
Delay	0 msec	3100 msec	100 msec	100 msec
Number of stitches at the start of sewing (Automatic back-tack, condensation sewing)	0	9	0	1
Number of stitches at the end of sewing (Automatic back-tack, condensation sewing)	0	9	0	1
Intermediate presser height setting	-	-	-	-
Thread tension setting	0	200	100	1
Thread tension reference value	0	200	100	1
Intermediate presser height reference value	-	-	-	-
Function No.	0	137	0	1

*** 1 : For LK-1901B and LK-1902B, the max. sewing speed value and the initial value will be 3,000 sti/min.**

For LK-1903B and LK-1900BW, the max. sewing speed value and the initial value will be 2,700 sti/min.

<AP series>

Item	Min. value	Max. value	Initial value	Increase/decrease unit.
Ordinary sewing pitch	0.1 mm	6.0 mm	2.0 mm	0.1 mm
Offset sewing pitch	0.1 mm	6.0 mm	2.0 mm	0.1 mm
Zigzag sewing pitch	0.1 mm	6.0 mm	2.0 mm	0.1 mm
Reverse sewing pitch	0.1 mm	6.0 mm	2.0 mm	0.1 mm
Zigzag width	0.1 mm	10.0 mm	3.0 mm	0.1 mm
Offset width	0.1 mm	99.9 mm	1.0 mm	0.1 mm
Double orderly sewing width	0.1 mm	99.9 mm	10.0 mm	0.1 mm
Double reverse sewing width	0.1 mm	99.9 mm	10.0 mm	0.1 mm
Jump feed speed	10 mm/s	500 mm/s	500 mm/s	10 mm/s
Sewing speed	500 sti/min	4000 sti/min	4000 sti/min	100 sti/min
Media pattern No.	1	999	1	1
Sewing machine memory No.	1	999	1	1
X direction enlargement/reduction ratio	20.00%	200.00%	100.00%	0.01%
Y direction enlargement/reduction ratio	20.00%	200.00%	100.00%	0.01%
External input terminal No.	0	15	0	1
External output terminal No.	0	15	0	1
Delay	0 msec	3100 msec	100 msec	100 msec
Number of stitches at the start of sewing (Automatic back-tack, condensation sewing)	0	9	0	1
Number of stitches at the end of sewing (Automatic back-tack, condensation sewing)	0	9	0	1
Intermediate presser height setting	-	-	-	-
Thread tension setting	0	200	100	1
Thread tension reference value	0	200	100	1
Intermediate presser height reference value	-	-	-	-
Function No.	0	137	0	1

21. BACKUP

The data created when pressing the backup button from the standard screen and performing the trial sewing is backed up in the sewing machine.

The continuation can be edited by using the backup data when moving to the body input next time.

Overwriting is performed on the current pattern when performing backup or trial sewing.

For this reason, when the pattern was selected from the media in the normal sewing mode, or users' pattern was edited, the data will disappear.



It is necessary to select the pattern again in the normal sewing mode.

Also, the backup data is overwritten when the pattern was selected from the media in the normal sewing mode or users' pattern was edited.

The backup data which is taken in at the time of moving to the body input becomes the pattern data which is currently selected.

22. ERROR CODE LIST

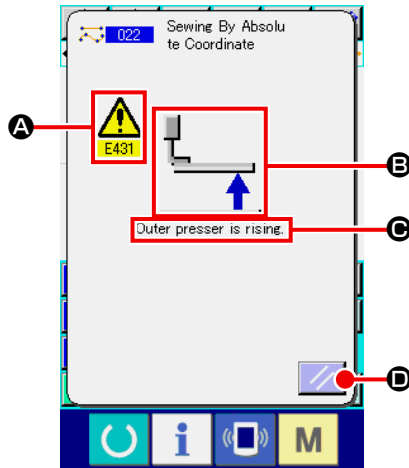









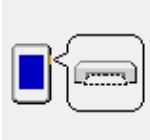



When an error occurs during motion of the body input mode, the error screen is displayed.



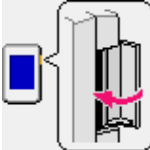

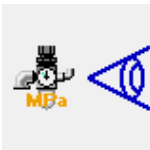
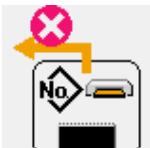

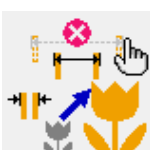
Error code is displayed at **A**, pictograph showing description of error at **B**, and error message at **C** in the error screen. Press RESET button  **D** to return to the normal operation.

Error code list of the body input mode is described as shown in the list below.

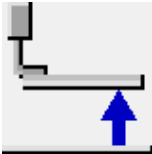
For the errors which are not described, refer to the error code list of the respective models.

Error No.	Display	Error description and corrective measure
E010		Pattern No. error Specified Pattern does not exist.
E011		External media not inserted. Media is not inserted.
E012		Read error Data cannot be read from external media.
E013		Write error Data cannot be written to external media.
E015		Format error Formatting cannot be performed.
E016		External media capacity over Capacity of external media is insufficient.
E019		File size over File is too large.

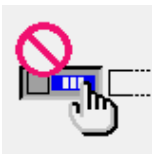
Error No.	Display	Error description and corrective measure
E024		<p>Memory size is over.</p> <ul style="list-style-type: none"> • Number of stitches that can be created with one element exceeds the limit. Create by dividing.
E029		<p>Lid of media slot is open.</p>
E030		<p>Needle is not in a proper position.</p> <ul style="list-style-type: none"> • When RESET switch is pressed, needle returns to UP position.
E031		<p>Air pressure drop Air pressure is dropped.</p>
E032		<p>File cannot be read.</p> <ul style="list-style-type: none"> • It cannot be handled due to the problem of compatibility or breakage of file.
E040		<p>Moving limit is over.</p>
E042		<p>Operation error Operation cannot be performed.</p> <ul style="list-style-type: none"> • When two points of the shape point are overlapped at the time of enlargement/reduction.
E043		<p>Max. pitch is exceeded.</p>
E045		<p>Pattern data is broken.</p>
E050		<p>Stop switch Temporary stop switch is pressed.</p> <ul style="list-style-type: none"> • When RESET switch is pressed, the machine returns to the origin.

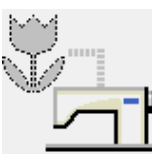

Error No.	Display	Error description and corrective measure
E431		<p>Feeding frame is lifting.</p> <ul style="list-style-type: none"> • Lower the frame.
E432		<p>Proper operation has not been performed.</p> <ul style="list-style-type: none"> • In case of circle and arc, two points of the shape point are not specified. • When two points of the shape point are in the same point successively.
E433		<p>Limit of number of stitches is over.</p>
E434		<p>Hardware error has occurred.</p>
E435		<p>Set value exceeds the range.</p>
E437		<p>Function cannot be selected.</p> <ul style="list-style-type: none"> • Function cannot be selected at the present point.
E438		<p>Execution error (execution processing function)</p> <ul style="list-style-type: none"> • Function cannot be executed.
E441		<p>Back-up data does not exist.</p>

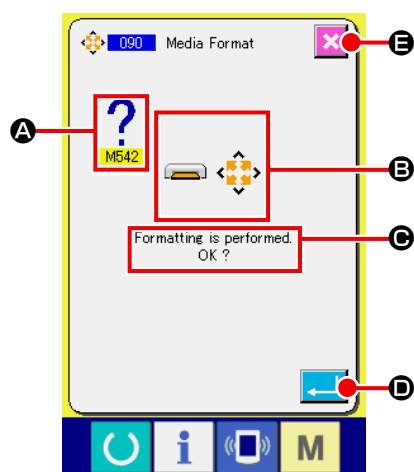
23. MESSAGE LIST











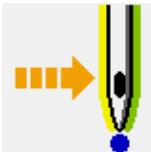

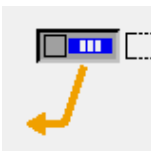

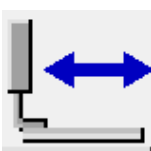
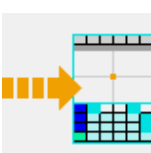
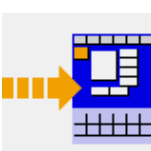
The list is the message screen displayed for confirmation of execution of processing in the body input mode.

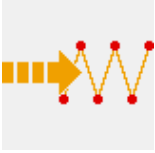
Message No. is displayed at **A**, pictograph showing the description of message at **B**, and message at **C** in the message screen.

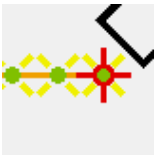
Press ENTER button  **D** to continue processing, and press CANCEL button  **E** to cancel.

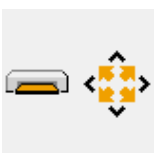
Message list of the body input mode is described as shown in the list below.

Message No.	Display	Description of message
M501		Erase confirmation Erasing is performed. OK ?
M502		Point change confirmation Point change is performed. OK ? • When the shape of the element is not kept, it is changed to the point.
M503		Overwriting confirmation Overwriting is performed. OK ?
M504		Execution confirmation Execution is performed. OK ?
M505		Thread trimming insertion confirmation Thread trimming is automatically inserted. OK ? • This error No. is displayed when there is no thread trimming at the end of sewing or before jump feed.
M507		Presser move confirmation Presser is moved. OK ? • Presser moves linearly. It interferes with the obstacle when there is any on the way.
M508		Input mode conversion confirmation Mode is converted to input mode. Create data newly ?
M509		Sewing mode conversion confirmation Data being created is erased and mode is converted to sewing mode. OK ? • When it is necessary to store the data, press CANCEL button to store.

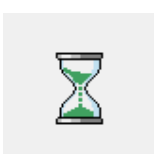
Message No.	Display	Description of message
M510		Standard zigzag change confirmation Zigzag stitch is changed to standard zigzag stitch. OK ?
M511		Midpoint of element mechanical control command deletion confirmation Mechanical control command of some midpoint of element is deleted. OK ? • Delete the command when re-operation of element is necessary.
M512		Shape point deletion confirmation Shape point is deleted. OK ?
M513		Needle entry point deletion confirmation Needle entry point is deleted. OK ?
M514		Element deletion confirmation Element is deleted. OK ?
M515		Mechanical control command deletion confirmation Mechanical control command is deleted. OK ?
M542		Format confirmation Formatting is performed. OK ?
M651		Pattern reading Pattern is being read.
M652		Pattern writing Pattern is being written.
M653		During formatting Formatting is being performed.
M999		Data processing