

Manufacturing Equipment

for the Apparel Industry

2019

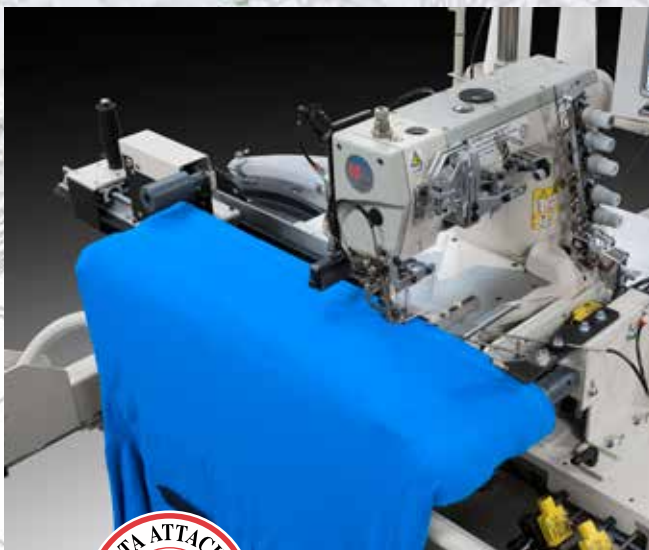

08-07-19



a Division of
HSM

72 Hours or FREE* Policy

As the leading supplier of automated sewing workstations, Atlanta Attachment Company pledges unequalled service and support to our valued customers. We pledge to maintain inventories of the recommended spare parts for our automated workstations* and to ship those replacement parts within 72 hours. If the expendable replacement parts are not shipped within 72 hours they will be Free of Charge!

* Contact sales for the recommended spare parts list and the model workstations covered.

Statement of Corporate Vision

- We will be primarily a manufacturer and provider of products and services to our customers which are of high quality and provide overall value for their investment.
- We will be noted for the delivery of these products and services on a timely basis.
- We will make use of advanced technology where practical and economical.
- The highest standards for material selection appropriate to the product / service will be maintained.
- We will strive to provide a work environment of integrity, respect and dignity for employees and all who come in contact with our business.
- Employees will be recruited and maintained who are creative, technically competent and productivity oriented.
- Management systems and processes will be developed and maintained which emphasize team work, a high level of quality assurance and flexibility.
- We will be a profitable company and distribute these assets in fair and equitable ways after sufficient reinvestment for necessary long-term company growth.
- We will be responsible to the environment and to the communities within which we do business.
- We will diversify into various markets and product lines in order to leverage our expertise, balance our work demands, provide new opportunities for growth and hedge against downturns in any one industry.



Atlanta Attachment Company

Innovative Technology for
the Sewn Products Industry Worldwide

Change Notice:

All content contained herein is subject to change without notice. Atlanta Attachment Company reserves the right to make changes, modifications, additions, corrections or deletions. Atlanta Attachment Company may terminate, change, suspend or discontinue any product in this catalog, including the availability of any products, at any time. Every effort is made to keep products up-to-date but due to the nature of printed media, changes may only be available on-line or by contacting your sales representative.

All materials contained herein are additionally protected by United States copyright law and may not be used, disclosed, reproduced, distributed, published or sold without the express written consent of Atlanta Attachment, which consent may be withheld in Atlanta Attachment's sole discretion. You may not alter or remove any copyright, trademark or other notice from copies of these materials.

Atlanta Attachment Company, Atlanta Parts Depot, Sudden Service, Sewing Automation, individually and when used in combination are registered trademarks of Atlanta Attachment Company. AAC is a division of HSM.

© 2019 Atlanta Attachment Company. All rights reserved.



Tee Shirts



PAGE	MODEL	DESCRIPTION
2	211E	Automatic Two-Needle Coverstitch Hemmer
3	211M	Semi-Automatic Two-Needle Coverstitch Hemmer
5	215	Automatic Blind-stitch Sleeve Hemmer (Sleeves/Pockets)
6	217	Automatic Blind-stitch Sleeve Hemmer (Bodies)
8	411	Automatic Hemmer/Seamer
11	996	Automatic Tee Shirt & Turtleneck Collar Workstation
15	1278-8	Automatic Coverstitch Bottom Hemmer
17	1354-950	Thermo-Label Transfer
20	1996	Automatic, Collar & Waistband Workstation
24	AP26M	Semi-Automatic Sleeve Closing Workstation
25	AP263	Automatic Short Sleeve Closing Workstation
33	273-37	Circular Collar Setting and Taping
39	1279	Circular Guiding Attachment
40	1289	Automatic Circular Collar Loading Rollers
46	3361K	Shoulder-to-Shoulder Taping Attachment with Cutter
47	AP22E4	Shirt Collar Set & Tape
48	AP26S	Automatic Backlatch System

Placket Golf Shirts

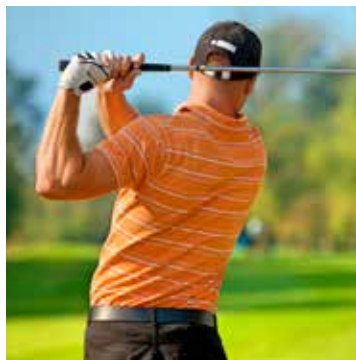

PAGE	MODEL	DESCRIPTION
4	213E	Automatic Two-Needle Hemming, Sleeves, and Bottoms
6	217	Automatic Blind-stitch Sleeve Hemmer (Bodies)
8	411	Automatic Hemmer/Seamer
9	981	Automatic Placket Fusing, Cutting, and Stacking
10	982	Automatic Placket Setting
15	1278-8	Automatic Coverstitch Bottom Hemmer
16	1353LFHL	Large Field Label Tacker
17	1354-950	Thermo-Label Transfer
24	AP26M	Semi-Automatic Sleeve Closing Workstation
25	AP263	Automatic Short Sleeve Closing Workstation
32	273-4	Fashion Collar Setting and Taping
45	1907A	Placket Shirt Collar Set & Tape
47	AP22E4	Shirt Collar Set & Tape
48	AP26S	Automatic Backlatch System

Sweat Shirts



PAGE	MODEL	DESCRIPTION
11	996	Automatic Tee Shirt & Turtleneck Collar Workstation
12	997C	Automatic Cuff
14	1278-6	Automatic Rib Knit Band Setting
16	1353LFHL	Large Field Label Tacker
17	1354-950	Thermo-Label Transfer
20	1996	Automatic, Collar & Waistband Workstation
22	AP23	Automatic Rib Knit Cuff Setting Station
26	AP264	Automatic Long Sleeve Closing Workstation
27	AP264T	Automatic Long Sleeve Close and Turn Workstation
39	1279	Circular Guiding Attachment
40	1289	Automatic Circular Collar Loading Rollers
47	AP22E4	Shirt Collar Set & Tape
48	AP26S	Automatic Backlatch System



INDEX - By Product Sewn

Hooded Sweat Shirts



PAGE	MODEL	DESCRIPTION
12	997C	Automatic Cuff
14	1278-6	Automatic Rib Knit Band Setting
16	1353LFHL	Large Field Label Tacker
17	1354-950	Thermo-Label Transfer
21	3800P	Automatic Set-In Pocket Workstation
22	AP23	Automatic Rib Knit Cuff Setting Station
23	AP24	Automatic Rib Knit Leg Cuff Setting Station
26	AP264	Automatic Long Sleeve Closing Workstation
27	AP264T	Automatic Long Sleeve Close and Turn Workstation
28	AP266	Automatic Leg Closing Workstation
35	350-25	Clean Finish Elastic Waistband Spiral Fold
38	1278-4	Circular Clean Finish Waistband Station
39	1279	Circular Guiding Attachment
44	1800P	Programmable Center Knife Gauge Set
47	AP22E4	Shirt Collar Set & Tape
48	AP26S	Automatic Backlatch System

Sweat Pants & Shorts



PAGE	MODEL	DESCRIPTION
7	350-50	Automatic Clean Finish Elastic Waistband Station
16	1353LFHL	Large Field Label Tacker
17	1354-950	Thermo-Label Transfer
18	1536A	Automatic Leg Elastic Hemming Station
21	3800P	Automatic Set-In Pocket Workstation
23	AP24	Automatic Rib Knit Leg Cuff Setting Station
28	AP266	Automatic Leg Closing Workstation
34	350-12	Clean Finish Elastic Waistband Station
35	350-25	Clean Finish Elastic Waistband Spiral Fold
38	1278-4	Circular Clean Finish Waistband Station
44	1800P	Programmable Center Knife Gauge Set
48	AP26S	Automatic Backlatch System
49	AP28	Electronic Metering

Folders, Attachments, and Other Equipment



PAGE	MODEL	DESCRIPTION
13	1100	Automatic Pant Leg Panel Serger
19	1987	Automatic Waistband Station
29	JA042	Velcro Feeder
36	425-14E	Spot Elastic Waistband
41-42	1325	High Speed Intermittent Rufflers
43	1375	Vibrating Binder
49	AP28	Electronic Metering
50	AT112	Programmable Cutter - Caps
51	AT116K	Programmable Fast Action Knife
52	AT116L	Programmable Jeans Front Pocket Taping System
53	AT140	Center Cut-Apart for Stripes
54	WW22	Walker Tape Feeder
55	-	Folders & Attachments
56	-	Gauge Sets
57	4059	Pedals
58	-	Pullers
59	-	Stands & Tables
60	PT-2000	Serial Bus Control System
61	HSView	Live Inventory Management
62-63	Bytetime	Shop Floor Control
64-67	APD	Parts



INDEX



WORKSTATIONS

PAGE	MODEL	DESCRIPTION	TEE SHIRTS	PLACKET SHIRT	SWEAT SHIRT	HOODED SWEAT SHIRT	SWEAT PANTS & SHORTS	OTHER
2	211E	Automatic Two-Needle Coverstitch Hemmer						
3	211M	Semi-Automatic Two-Needle Coverstitch Hemmer						
4	213E	Automatic Two-Needle Hemming, Sleeves, and Bottoms						
5	215	Automatic Blind-stitch Sleeve Hemmer (Sleeves/Pockets)						
6	217	Automatic Blind-stitch Sleeve Hemmer (Bodies)						
7	350-50	Automatic Clean Finish Elastic Waistband Station						
8	411	Automatic Hemmer/Seamer						
9	981	Automatic Placket Fusing, Cutting, and Stacking						
10	982	Automatic Placket Setting						
11	996	Automatic Tee Shirt & Turtleneck Collar Workstation						
12	997C	Automatic Cuff						
13	1100	Automatic Pant Leg Panel Serger						
14	1278-6	Automatic Rib Knit Band Setting						
15	1278-8	Automatic Coverstitch Bottom Hemmer						
16	1353LFHL	Large Field Label Tacker						
17	1354-950	Thermo-Label Transfer Machine						
18	1536A	Automatic Leg Elastic Hemming Station						
19	1987	Automatic Waistband Station						
20	1996	Automatic Collar & Waistband Workstation						
21	3800P	Automatic Set-In Pocket Workstation						
22	AP23	Automatic Rib Knit Cuff Setting Station						
23	AP24	Automatic Rib Knit Leg Cuff Setting Station						
24	AP26M	Semi-Automatic Sleeve Closing Workstation						
25	AP263	Automatic Short Sleeve Closing Workstation						
26	AP264	Automatic Long Sleeve Closing Workstation						
27	AP264T	Automatic Long Sleeve Close and Turn Workstation						
28	AP266	Automatic Leg Closing Workstation						
29	JA042	Velcro Feeder						



ATTACHMENTS & OTHER

PAGE	MODEL	DESCRIPTION	TEE SHIRTS	PLACKET SHIRT	SWEAT SHIRT	HOODED SWEAT SHIRT	SWEAT PANTS & SHORTS	OTHER
32	273-4	Fashion Collar Setting and Taping						
33	273-37	Circular Collar Setting and Taping						
34	350-12	Clean Finish Elastic Waistband Station						
35	350-25	Clean Finish Elastic Waistband Spiral Fold						
36	425-14E	Spot Elastic Waistband						
37	987	Air Guided Hemmer						
38	1278-4	Circular Clean Finish Waistband Station						
39	1279	Circular Guiding Attachment						
40	1289	Automatic Circular Collar Loading Rollers						
41-42	1325	Rufflers						
43	1375	Vibrating Binder						
44	1800P	Programmable Center Knife Gauge Set						
45	1907A	Placket Shirt Collar Set & Tape						
46	3361K	Shoulder-to-Shoulder Taping Attachment with Cutter						
47	AP22E4	Shirt Collar Set & Tape						
48	AP26S	Automatic Backlatch System						
49	AP28	Electronic Metering						
50	AT112	Programmable Cutter - Caps						
51	AT116K	Programmable Fast Action Knife						
52	AT116L	Programmable Jeans Front Pocket Taping System						
53	AT140	Center Cut-Apart for Stripes						
54	WW22	Walker Tape Feeder						
55		Folders & Attachments						
56		Gauge Sets						
57	4059	Pedals						
58		Pullers						
59		Stands & Tables						
60	PT-2000	Serial Bus Control System						
61	HSView	Live Inventory Management						
62-63	Bytetime	Shop Floor Control						
64-67	APD	Parts						

SEWING WORKSTATIONS



Attachment Comp
369 • Sudden Service

Attachment Company
369 • Sudden Service® • atlatt.com



Automatic Two-Needle Coverstitch Hemmer

Sleeves and Pockets

- Patented Serial Bus Control System
- Decorative trim may be added to any hem style*
- Electronic sleeve edge guiding system (option)
- Independent sleeve edge trimmer
- Top & bottom coverstitch (option)
- Electronic controls with DC drive motor

DESCRIPTION

An electronically controlled workstation consisting of a conveyORIZED downturn hemming system with two or three needle bottom and/or top coverstitch sewing head, electronic motor, automatic edge trimmer, cut apart with stacker and self-contained waste disposal.

OPERATION

The operator places parts to an edge guide and initiates sewing. The unit will continue sewing as long as parts are placed on the conveyor. The sew cycle will automatically stop if the operator fails to continue the loading process. Thread savings is achieved as a result of the machine not sewing when the distance between the parts becomes excessive.

OPTIONS

- **2211-EG2** - Edge guiding system
- **2211PKIT01** - Pocket loading station
- **211-KIT01** - Thread handling
- **311-006B** - Fold in half stacker

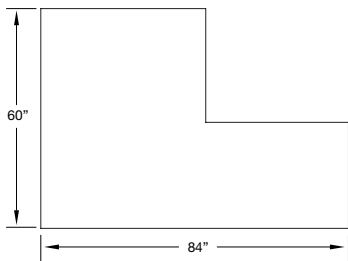

Footprint

Images may include options.

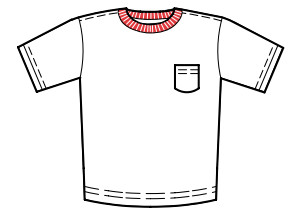
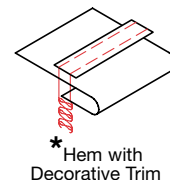
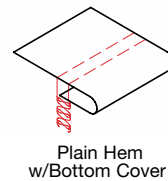

SPECIFICATIONS	
Voltage (v/ph/hz)	220v 1ph
Current (amps)	5
Air pressure (psi)	90
Air consumption (cfm)	19
Shipping weight (lbs)	1300
Shipping dimensions (w/l/h, inch)	106 x 60 x 65

PRODUCTION	
Pieces per hour	1950

Depending on material and size of parts

www.atlatt.com • sales@atlatt.com

PATENTS: Our equipment may be covered by one or more patents. Please go to the following web page for an up-to-date patent list: www.atlatt.com/patents.php © 2018 Atlanta Attachment Co. 19151080719

362 Industrial Park Drive
Lawrenceville, GA 30046 USA
+1 (770) 963-7369 • FAX +1 (770) 963-7641



Atlanta Attachment Company

The Company that
Sudden Service
built

Semi-automatic Two-Needle Sleeve Hemmer

- Low Cost
- Simple to Operate
- Easy to Maintain
- Coverstitch does not ravel back
- Quality flat hems - No twist or roping
- Sewing head with top feed
- Two-or-three needle sewing head
- Sewing head with top feed and under-trimmer
- Sewing head with thread under-trimmer
- Auto Stacker
- Sewing head with puller and thread impact cutter
- Top coverstitch
- Two or three needle
- Electronic DC Motor

OPERATION

The operator loads the sleeve under the presser foot. The machine starts and hems the sleeve. After hemming, the sleeve may be left in a chain or the thread can be cut and the sleeve stacked.

OPTIONS

- **0211-300** Folder assembly 211M
- **211-KIT03** Thread tension release
- **211MKIT01** Vacuum chain remover
- **191297C** AAC, Blow gun & light
- **SP211M** Spare parts kit

Images may include options.

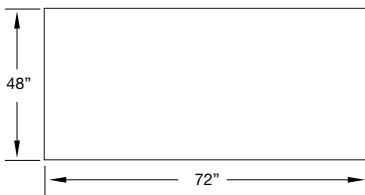

Footprint

SPECIFICATIONS	
Voltage (v/ph/hz)	220v 1ph
Current (amps)	5
Air pressure (psi)	90
Air consumption (cfm)	19
Shipping weight (lbs)	950
Shipping dimensions (w/l/h, inch)	60 x 62 x 60

PRODUCTION	
Pieces per hour	125

Depending on material and size of parts

www.atlatt.com • sales@atlatt.com

PATENTS: Our equipment may be covered by one or more patents. Please go to the following web page for an up-to-date patent list: www.atlatt.com/patents.php
© 2018 Atlanta Attachment Co. 19151080719

362 Industrial Park Drive
Lawrenceville, GA 30046 USA
+1 (770) 963-7369 • FAX +1 (770) 963-7641



Atlanta Attachment Company

The Company that
Sudden Service
built

Automatic Two-Needle Hemmer

Sleeves and Bottoms

An electronically controlled workstation consisting of a conveyORIZED downturn hemming apparatus with two-or-three needle bottom and/or top coverstitch sewing head, electronic motor, automatic edge trim and cut apart, and self-contained waste disposal.

Sleeves • Bottoms

- Patented Serial Bus Control System
- DC electronic motor & controls
- Reliable edge trimmer
- Fold-in-half & stack or stack only
- Stacker & return conveyor for bottom hemming available
- Optional imitation cuff attachment (patented)

OPERATION

The operator places parts to an edge guide and initiates sewing. The unit will continue sewing as long as parts are placed on the conveyor within a specific distance. The sew cycle will stop if the operator fails to position the next part.

OPTIONS

- **2211-EG3** - Edge guiding system
- **2211PKIT01** - Pocket loading station
- **211-KIT01** - Thread handling
- **311-006B** - Fold in half stacker
- **311-5A** - Top cover 3 needles

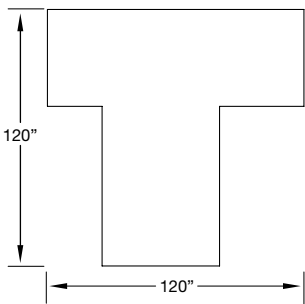

Footprint

Images may include options.

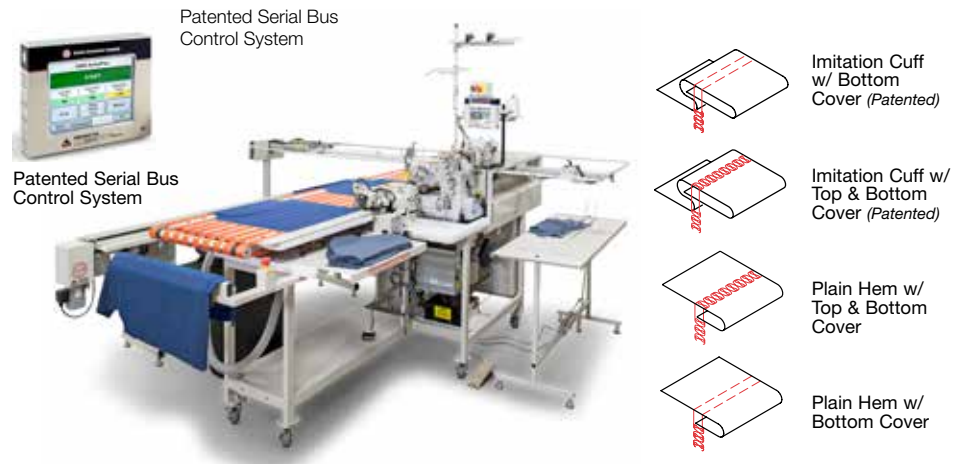

SPECIFICATIONS	
Voltage (v/ph/hz)	220v 1ph
Current (amps)	5
Air pressure (psi)	90
Air consumption (cfm)	21
Shipping weight (lbs)	1700
Shipping dimensions (w/l/h, inch)	132 x 72 x 65
PRODUCTION	
Sleeves per hour	1950
Bottoms per hour	1245

Depending on material and size of parts

www.atlatt.com • sales@atlatt.com

PATENTS: Our equipment may be covered by one or more patents. Please go to the following web page for an up-to-date patent list: www.atlatt.com/patents.php © 2018 Atlanta Attachment Co. 19151080719

362 Industrial Park Drive
Lawrenceville, GA 30046 USA
+1 (770) 963-7369 • FAX +1 (770) 963-7641



Atlanta Attachment Company
The Company that
Sudden Service
built

Automatic Blindstitch Sleeve Hemmer

Sleeves & Pockets

An electronically controlled workstation consisting of a conveyORIZED upturn hemming apparatus with two-or-three thread overlock sewing head, electronic motor, automatic edge trim and cut apart, and self-contained waste disposal.

OPERATION

The operator places parts to an edge guide and initiates sewing. The unit will continue sewing as long as parts are placed on the conveyor within a specific distance. The sew cycle will stop if the operator fails to position the next part.

OPTIONS

- **2211-EG3** - Edge guiding system
- **2211PKIT01** - Pocket loading station
- **311-006B** - Fold in half stacker

Images may include options.



Patented Serial Bus Control System

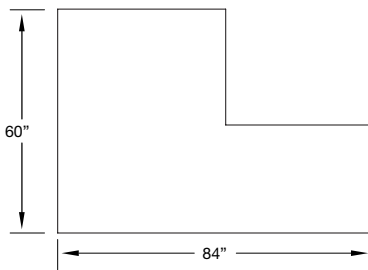
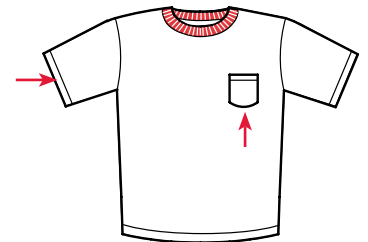

Footprint

SPECIFICATIONS

Voltage (v/ph/hz)	220v 1ph
Current (amps)	5
Air pressure (psi)	90
Air consumption (cfm)	21
Shipping weight (lbs)	1300
Shipping dimensions (w/l/h, inch)	106 x 60 x 65
PRODUCTION	
Sleeves per hour	1450-1650
Pockets per hour	1245

Depending on material and size of parts

www.atlatt.com • sales@atlatt.com

PATENTS: Our equipment may be covered by one or more patents. Please go to the following web page for an up-to-date patent list: www.atlatt.com/patents.php © 2018 Atlanta Attachment Co. 19151080719

362 Industrial Park Drive
Lawrenceville, GA 30046 USA
+1 (770) 963-7369 • FAX +1 (770) 963-7641



Atlanta Attachment Company

The Company that
Sudden Service
built

Automatic Blindstitch Sleeve Hemmer

Shirt Bodies and Sleeves

An electronically controlled workstation consisting of a conveyORIZED upturn hemming apparatus with two-or-three thread overlock sewing head, electronic motor, automatic edge trim and cut apart, and self-contained waste disposal.

OPERATION

The operator places parts to an edge guide and initiates sewing. The unit will continue sewing as long as parts are placed on the conveyor within a specific distance. The sew cycle will stop if the operator fails to position the next part.

OPTIONS

- **2211-EG3** - Edge guiding system
- **2211PKIT01** - Pocket loading station
- **311-006B** - Fold in half stacker

Images may include options.

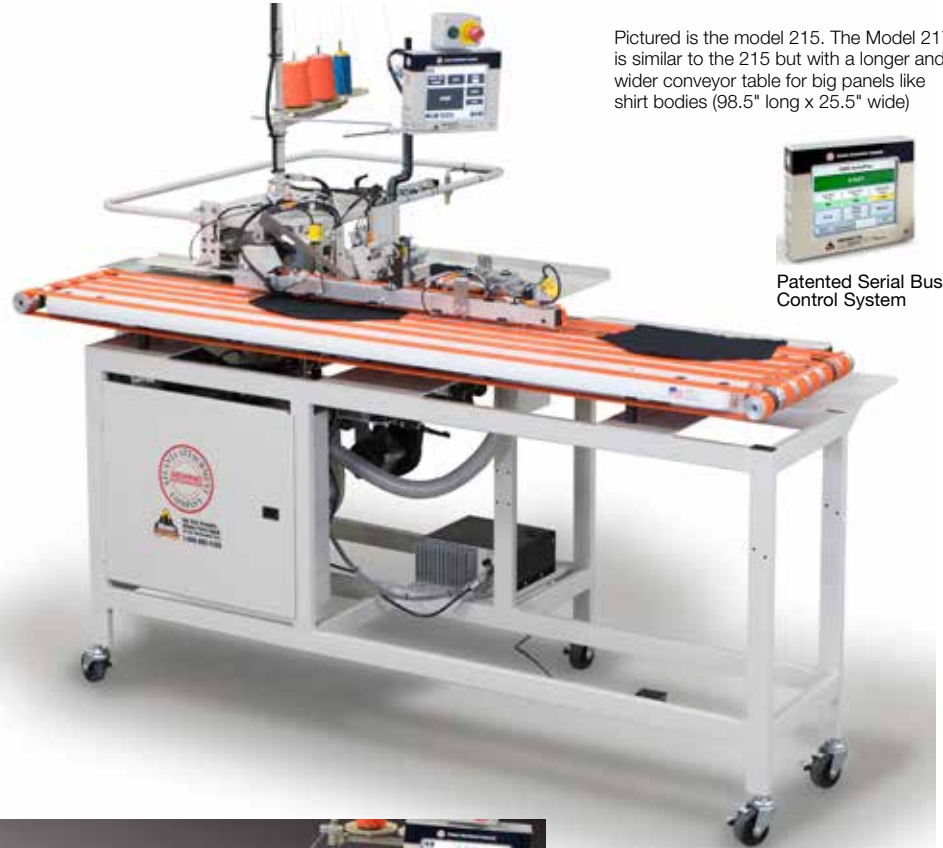

Pictured is the model 215. The Model 217 is similar to the 215 but with a longer and wider conveyor table for big panels like shirt bodies (98.5" long x 25.5" wide)



Patented Serial Bus Control System

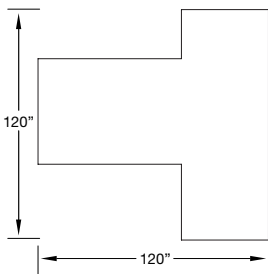
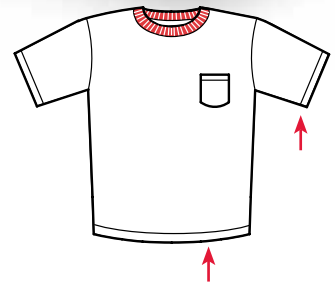

Footprint

SPECIFICATIONS	
Voltage (v/ph/hz)	220v 1ph
Current (amps)	5
Air pressure (psi)	90
Air consumption (cfm)	21
Shipping weight (lbs)	1300
Shipping dimensions (w/l/h, inch)	106 x 60 x 65
PRODUCTION	
Sleeves per hour	1450-1650
Pockets per hour	1245

Depending on material and size of parts

www.atlatt.com • sales@atlatt.com

PATENTS: Our equipment may be covered by one or more patents. Please go to the following web page for an up-to-date patent list: www.atlatt.com/patents.php © 2018 Atlanta Attachment Co. 19151080719

362 Industrial Park Drive Lawrenceville, GA 30046 USA +1 (770) 963-7369 • FAX +1 (770) 963-7641



Atlanta Attachment Company

The Company that **Sudden Service** built

Automatic Clean Finish Elastic Waistband Workstation

- Tunnel Elastic
- Deskills difficult operation
- Auto start-stop
- Auto cut apart
- Automatic fold-in-half stacker
- Parts ready for next operation
- DC electronic motor & microprocessor controls
- Electronic elastic metering
- Automatic piece counter

DESCRIPTION

An electro-pneumatic clean finish waistband station consisting of a multi-needle sewing machine, motor, stand, spiral elastic guide, pneumatic knife (for cut apart) and variable speed conveyor with electronic metering device and fold-in-half stacker.

OPERATION

The operator presents the flat garment to the edge guide and into the spiral folder. An electric eye senses the leading edge and starts the sew cycle. The operator holds the garment against the edge guide until completely into the folder. The electric eye senses the trailing edge and stops the sew cycle leaving the proper spacing for the next garment to eliminate waste. The operator then picks up the next garment and repeats. The conveyor will carry pieces to the knife for automatic cut apart and then to the rear fold-in-half stacker. This unit sews and cuts garments apart then folds the garment in half for the side seam operation.

(Special gauge parts are available)

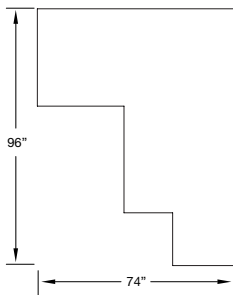

Footprint

Images may include options.

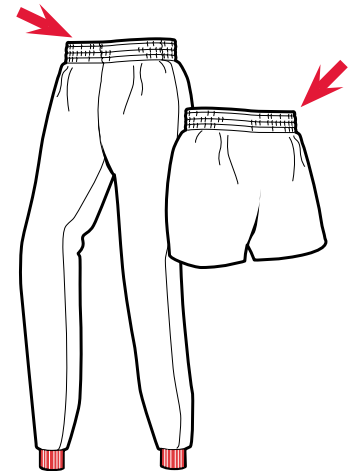

SPECIFICATIONS	
Voltage (v/ph/hz)	220v 1ph
Current (amps)	5
Air pressure (psi)	90
Air consumption (cfm)	10
PRODUCTION	
Pieces per hour	600

Depending on material and size of parts

www.atlatt.com • sales@atlatt.com

PATENTS: Our equipment may be covered by one or more patents. Please go to the following web page for an up-to-date patent list: www.atlatt.com/patents.php © 2018 Atlanta Attachment Co. 19151080719

362 Industrial Park Drive
Lawrenceville, GA 30046 USA
+1 (770) 963-7369 • FAX +1 (770) 963-7641



Atlanta Attachment Company
The Company that
Sudden Service
built

Images may include options.

Automatic Hemmer/Seamer

An electronically controlled automatic workstation consisting of a conveyORIZED hemming system, fold-in-half station, a closing station with automatic backlatch and a programmable indexing stacker.

- Patented Serial Bus Control System
- DC electronic motor
- Combines hemming and closing operations with auto backlatch
- Sews 100% cotton thread max RPM
- Plain hem or imitation collarete style (patented)
- "No tool" adjustments by operator
- Auto indexing stacker
- Computerized soft touch control system
- Adjustable transfer station for closing straight or contour seams
- Unique automatic fold-in-half system allows sleeves to be overlapped during sew cycle, increasing production
- Self-contained waste removal system
- Operator and technician friendly for easy adjustments and maintenance

OPERATION

The operator places parts to an edge guide, initiates the sewing cycle and continues loading. The sleeves are automatically trimmed, folded, hemmed, folded in half, transported to closer, backlatched, closed and stacked. Stacker indexing is accomplished through programming of the number of sleeves in a bundle.

OPTIONS

- **2211-EG1** - Active Edge Guide
- **311-5A** - Top cover 3 needles



Hemming



Fold-in-half station and closing stations

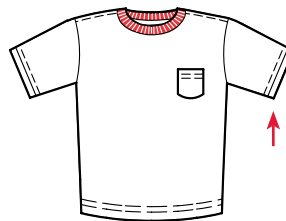

Patented Serial Bus Control System

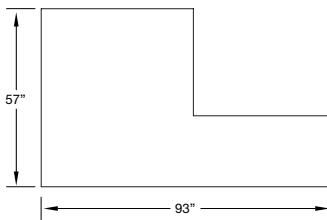

Footprint

SPECIFICATIONS	
Voltage (v/ph/hz)	220v 1ph
Current (amps)	15
Air pressure (psi)	90
Air consumption (cfm)	25
Shipping weight (lbs)	1950
Shipping dimensions (w/l/h, inch)	106 x 65 x 67
PRODUCTION / PRODUCCIÓN	
Pieces per hour	1950 hemmed & closed

Depending on material and size of parts

www.atlatt.com • sales@atlatt.com

PATENTS: Our equipment may be covered by one or more patents. Please go to the following web page for an up-to-date patent list: www.atlatt.com/patents.php © 2018 Atlanta Attachment Co. 19151080719

362 Industrial Park Drive
Lawrenceville, GA 30046 USA
+1 (770) 963-7369 • FAX +1 (770) 963-7641



Atlanta Attachment Company

The Company that
Sudden Service
built

Automatic Placket Fusing, Cutting and Stacking

An adjustable, easy to load, placket attachment utilizing a fusing machine that has both top and bottom heating elements for faster belt speed, an automatic cutter, stacker, and counter.

- Plackets may be individually cut or roll fed
- Simple, easy to adjust placket attachment
- Upper and lower heating elements for faster belt speed
- Automatic cool-down cycle
- Cutter automatically cuts plackets to correct length, counts, stacks, and discards waste
- Modular design
- Modules may be purchased separately
- Use pre-slotted or plain interlining
- Plain lining slit automatically

OPERATION

When using a roll feed placket, the operator loads a roll of fusing and a roll of placket material, presses the start button, and the stacker continues to run until the desired number of plackets is reached.

When using individually cut plackets, the operator loads a roll of fusing and hand loads the plackets. The fused plackets are automatically cut to the correct length, counted, stacked and the waste is cut away. The plackets are indexed when the desired quantity is reached for each stack. The automatic cutter/stacker requires no additional attention.

OPTIONS

All modules may be purchased separately.

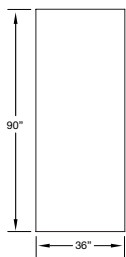

Footprint

Images may include options.



SPECIFICATIONS	
Voltage (v/ph/hz)	220v 1ph
Current (amps)	25
Air pressure (psi)	90
Air consumption (cfm)	10
Shipping weight (lbs)	800
Shipping dimensions (w/l/h, inch)	72 x 62 x 60
PRODUCTION	
Pieces per hour - individually fed packets	1410
Pieces per hour - continuously fed packets	2220

Depending on material and size of parts

www.atlatt.com • sales@atlatt.com

PATENTS: Our equipment may be covered by one or more patents. Please go to the following web page for an up-to-date patent list: www.atlatt.com/patents.php © 2018 Atlanta Attachment Co. 19151080719

362 Industrial Park Drive
Lawrenceville, GA 30046 USA
+1 (770) 963-7369 • FAX +1 (770) 963-7641



Atlanta Attachment Company

The Company that
Sudden Service
built

Automatic Placket Setting

- 1/8" needle gauge ensures quality
- Wider needle gages available for old style plackets
- Loads from either side
- Programmable center knife
- Patented Serial Bus Control System
- Self-diagnostic software
- Knife operates independent of sewing head
- Laser alignment lights
- Automatic repair mode for thread breaks
- Sews, slits, and backtacks
- Auto-Stacker with easy unload feature
- Bobbin thread monitor
- Sizes: Small to XXXL
- Simple to operate and maintain

OPERATION

The operator places the shirt front and placket precisely with laser lights. Garment transfers to sewing position and sewing cycle begins automatically. After sewing, thread is cut and garment is automatically stacked. Should the thread break, the machine stops, backtacks to facilitate the repair, and eliminates the need to repair off line.

Images may include options.



Patented Serial Bus Control System

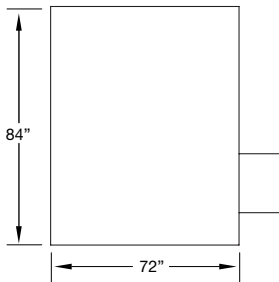
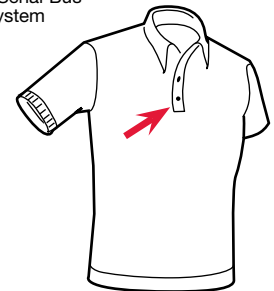

Footprint

SPECIFICATIONS	
Voltage (v/ph/hz)	220v 1ph
Current (amps)	10
Air pressure (psi)	90
Air consumption (cfm)	10
Shipping weight (lbs)	1300
Shipping dimensions (w/l/h, inch)	96 x 72 x 63
PRODUCTION	
Pieces per hour	360

Depending on material and size of parts

www.atlatt.com • sales@atlatt.com

PATENTS: Our equipment may be covered by one or more patents. Please go to the following web page for an up-to-date patent list: www.atlatt.com/patents.php © 2018 Atlanta Attachment Co. 19151080719

362 Industrial Park Drive
Lawrenceville, GA 30046 USA
+1 (770) 963-7369 • FAX +1 (770) 963-7641



Atlanta Attachment Company

The Company that
Sudden Service
built

Automatic Tee Shirt & Turtleneck Collar machine

- Patented Serial Bus Control System with self-diagnostic software
- Cuts single or dual, rolled or festooned material
- Auto-indexing stacker tray
- 1" to 24" cut length
- Auto-stop
- Easy size adjustment

DESCRIPTION

A fully automatic rib knit collar workstation, utilizing a programmable microprocessor with touch screen for operator input and style recall. The self-diagnostic software prompts the operator or technician to quickly identify a problem.

OPERATION

The rib knit collar material may be tubular or pre-seamed utilizing the optional sewing module. After loading, the operation is fully automatic. This workstation may be programmable to produce a predetermined style or quantity of collars.

Images may include options.



Patented Serial Bus Control System

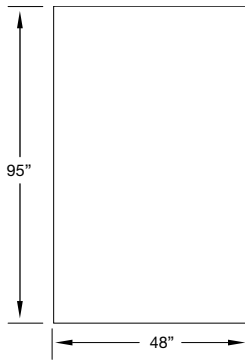

Footprint

SPECIFICATIONS	
Voltage (v/ph/hz)	220v 1ph
Current (amps)	5
Air pressure (psi)	90
Air consumption (cfm)	10
Shipping weight (lbs)	1100
Shipping dimensions (w/l/h, inch)	96 x 55 x 60
PRODUCTION	
Pieces per hour	4440

Depending on material and size of parts

www.atlatt.com • sales@atlatt.com

PATENTS: Our equipment may be covered by one or more patents. Please go to the following web page for an up-to-date patent list: www.atlatt.com/patents.php
© 2018 Atlanta Attachment Co. 19151080719

362 Industrial Park Drive
Lawrenceville, GA 30046 USA
+1 (770) 963-7369 • FAX +1 (770) 963-7641



Atlanta Attachment Company

The Company that
Sudden Service
built

Automatic Cuff Machine

A fully automatic rib knit cuff workstation, utilizing a programmable microprocessor with touch screen for operator input and style recall. The self-diagnostic software prompts the operator or technician to quickly identify a problem.

- 30 Rib knit cuffs cut, folded, and counted per minute
- Tubular or with seams
- Touch screen stores up to 25 styles
- Select the language of your choice
- Fully automatic operation after loading
- Microprocessor controls
- Self-diagnostic software

OPERATION

The rib knit cuff material may be tubular or pre-seamed utilizing the optional sewing module. After loading, the operation is fully automatic. This workstation may be programmable to produce a predetermined style or quantity of cuffs.

OPTIONS

997S - Automatic seamer module

Images may include options.



Optional Model 997S

Model 997S



Knit cuffs



Patented Serial Bus Control System

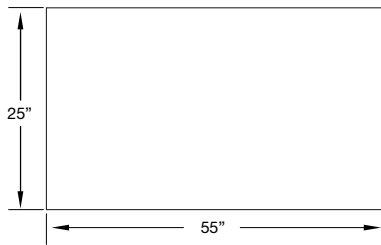
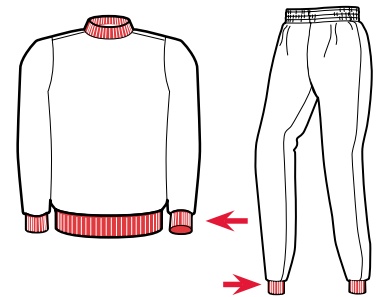

Footprint

SPECIFICATIONS

Voltage (v/ph/hz)	220v 1ph
Current (amps)	5
Air pressure (psi)	90
Air consumption (cfm)	10
Shipping weight (lbs)	1200
Shipping dimensions (w/l/h, inch)	96 x 60 x 65
PRODUCTION	
Pieces per hour* / Piezas por hora*	1800

Depending on material and size of parts

www.atlatt.com • sales@atlatt.com

PATENTS: Our equipment may be covered by one or more patents. Please go to the following web page for an up-to-date patent list: www.atlatt.com/patents.php © 2018 Atlanta Attachment Co. 19151080719

362 Industrial Park Drive
Lawrenceville, GA 30046 USA
+1 (770) 963-7369 • FAX +1 (770) 963-7641



Atlanta Attachment Company

The Company that
Sudden Service
built

Automatic Panel Serger

- Patented Serial Bus Control System
- Programmable to sew 3 or 4 sides
- Easy access to sewing head
- Space saving design
- Stitch condensing at the corners
- Automatic start
- Automatic stacking
- Operator can run multiple machines
- Electric/pneumatic lockout-tag
- Electronic DC Motor
- Programmable repair cycle

DESCRIPTION

A fully automatic panel serging workstation, utilizing a programmable microprocessor with touch screen for operator input and style recall. The self-diagnostic software prompts the operator or technician to quickly identify a problem.

OPERATION

The operator simply loads the pants panel in the 1100 and sewing starts automatically. Stacking is automatic which allows the operator to load multiple machines. One operator can load up to 5 machines.

Images may include options.



Patented Serial Bus Control System

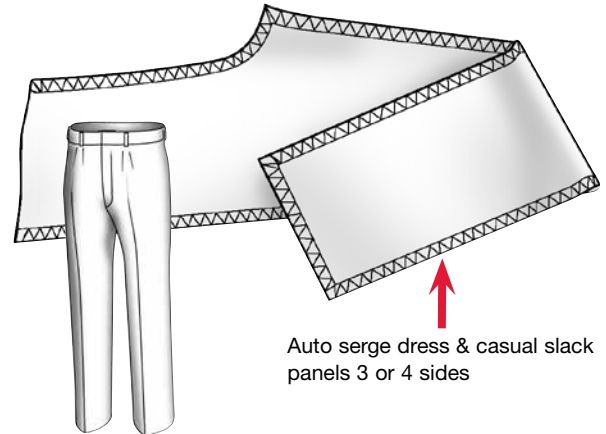

Auto serge dress & casual slack panels 3 or 4 sides

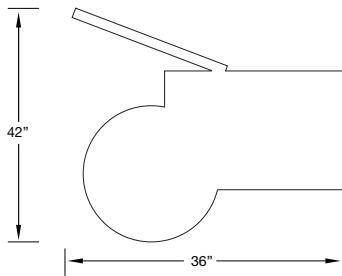

Footprint

SPECIFICATIONS	
Voltage (v/ph/hz)	220v 1ph
Current (amps)	12
Air pressure (psi)	90
Air consumption (cfm)	12
Shipping weight (lbs)	650
Shipping dimensions (w/l/h, inch)	48 x 48 x 60
PRODUCTION	
Pieces per hour	230-235

Depending on material and size of parts, one operator can maintain multiple workstations, up to 5

www.atlatt.com • sales@atlatt.com

PATENTS: Our equipment may be covered by one or more patents. Please go to the following web page for an up-to-date patent list: www.atlatt.com/patents.php © 2018 Atlanta Attachment Co. 19151080719

362 Industrial Park Drive
Lawrenceville, GA 30046 USA
+1 (770) 963-7369 • FAX +1 (770) 963-7641



Atlanta Attachment Company

The Company that
Sudden Service
built

Automatic Rib Knit Band Setting

Shirt and Band May Be Tubular or with Side Seams

- DC electronic motor & microprocessor controls
- Tandem operation
- Reduces ergonomic risk
- Minimizes fabric waste
- Uniform gathering
- Dual electronic active edge guiding system for band & body
- Automatic stack
- Increased production
- Piece counter
- Yamato AZ8403, Juki, Pegasus

DESCRIPTION

An automatic workstation for sewing circular rib knit bottom bands on sweat shirts. This unit incorporates a cylinder arm overlock sewing head with vacuum thread trimmer, electronic controls, dual electronic active edge guiding system for band and body, and pneumatic expansion rollers with automatic stacker.

OPERATION

The operator folds the circular rib knit piece in half to form a band and places it over the expansion guide rollers. The rollers automatically expand for loading the body. The body is loaded over the rollers and band and a touch of the start sensor expands the rollers to sew position and indexes the parts under the presser foot and sew cycle begins. The operator is free to load a second machine. When the finished seam is sensed, the parts are oversewn a predetermined distance, thread chain is cut, and the part is automatically stacked.

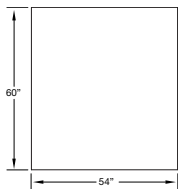

Footprint

Images may include options.



Patented Serial Bus Control System

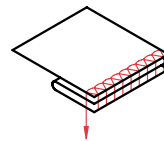
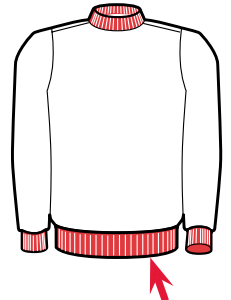

SPECIFICATIONS

Voltage (v/ph/hz)	220v 1ph
Current (amps)	6
Air pressure (psi)	90
Air consumption (cfm)	23
Shipping weight (lbs)	890
Shipping dimensions (w/l/h, inch)	60 x 54 x 60
PRODUCTION	
Pieces per hour	510

Depending on material and size of parts

www.atlatt.com • sales@atlatt.com

PATENTS: Our equipment may be covered by one or more patents. Please go to the following web page for an up-to-date patent list: www.atlatt.com/patents.php
© 2018 Atlanta Attachment Co. 19151080719

362 Industrial Park Drive
Lawrenceville, GA 30046 USA
+1 (770) 963-7369 • FAX +1 (770) 963-7641



Atlanta Attachment Company

The Company that
Sudden Service
built

Images may include options.

Automatic Coverstitch Bottom Hemmer

Shirts may be tubular or with side seams

- Patented Serial Bus Control System
- Shirt may be hemmed first or last operation
- Tandem operation
- Automatic size control
- Perfectly aligned over-sew
- Electronic active edge guiding system
- 100% cotton thread max RPM

DESCRIPTION

An electronically controlled workstation for hemming circular shirt bottoms. This unit incorporates a two-needle coverstitch sewing head with an optional left-hand knife with electro-pneumatic expansion rollers for size control, a state-of-the-art edge guiding system, a fabric folding system, and an automatic stacker.

OPERATION

A tubular or side-seamed body is loaded over the expansion rollers. When loaded, the rollers expand to the proper tension, indexes the shirt under the presser foot, and the sewing cycle is initiated. The operator is free to load a second station. The finished hem is sensed and perfectly oversewn (with stitch-condensing if desired). The threads are trimmed and the garment is automatically stacked.

OPTIONS

- Stitch condenser
- Left-hand knife
- Top or bottom coverstitch
- Flip seam device
- Side seam recognition

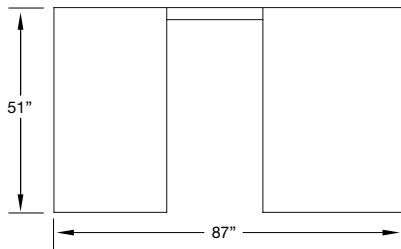

Footprint



Patented Serial Bus Control System

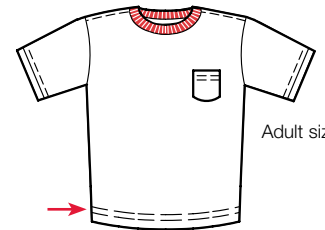

Adult sizes

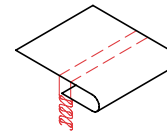

Plain Hem w/Bottom Cover

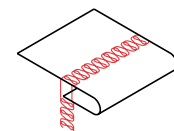

Plain Hem w/Top & Bottom Cover

SPECIFICATIONS	
Voltage (v/ph/hz)	220v 1ph
Current (amps)	6.5
Air pressure (psi)	90
Air consumption (cfm)	15
Shipping weight (lbs)	890
Shipping dimensions (w/l/h, inch)	60 x 54 x 60
PRODUCTION	
Pieces per hour	660

Depending on material and size of parts, based on tandem setup

www.atlatt.com • sales@atlatt.com

PATENTS: Our equipment may be covered by one or more patents. Please go to the following web page for an up-to-date patent list: www.atlatt.com/patents.php © 2018 Atlanta Attachment Co. 19151080719

362 Industrial Park Drive
Lawrenceville, GA 30046 USA
+1 (770) 963-7369 • FAX +1 (770) 963-7641



Atlanta Attachment Company

The Company that
Sudden Service
built

Large Field Label Tacker

- Extra Large Sewing Field 78" x 40"
- Tooling recognition (bar code) with automatic pattern selection
- Touch Screen Operation
- Can be programmed directly by way of the touchscreen on board the machine, but also through PC software which allows for greater detail control with expanded features and import options
- Depending on tooling, labels or handles can be positioned on top of the border and sewn in place. In some cases, items such as labels can be sewn with the item below the border.
- Maximum storage of 200 different patterns
- Gear belt transmission of the sewing carriage for smooth, controlled, operation.
- Quiet operation and simple maintenance.
- Precision drive with AC Servo control for positioning accuracy
- Heavy Duty Thread trimming system with Large Capacity bobbin

Images may include options.

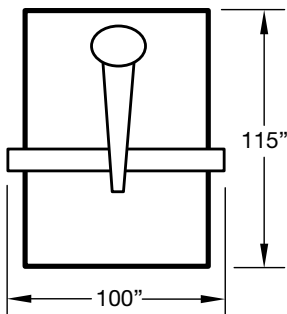

Footprint

SPECIFICATIONS / ESPECIFICACIONES

Max sewing speed (rpm) / Max velocidad de costura (rpm)	2,500
Factory preset speed (rpm) / Velocidad de fábrica (rpm)	1,800
Needle system / Sistema de aguja	SN135X1722
Needle size / Tamaño de aguja	22-130
Sewing field (cm) / Campo de costura (cm)	200 x 100
Weight of material / Tipo de material	LIGHT / MEDIUM
Voltage (v/ph/hz) / Voltaje (v/ph/hz)	220 1P 60HZ
Power (watts) / Amperaje (watts)	1,400
Motor type / Tipo de motor	Servo
Air pressure (psi) / Presión de aire (psi)	80
Air consumption (cfm) / Consumo de aire (cfm)	1
Shipping weight (lbs) / Peso de embarque (lbs)	1650
Shipping dimensions (w/l/h, inch) / Dimensiones de embarque (w/l/h, pulgadas)	55 x 102 x 55

PRODUCTION / PRODUCCIÓN

Varies depending on pattern sewn - 8 hr Varía dependiendo del patrón a coser 8 hr	100-400
--	---------

www.atlatt.com • sales@atlatt.com

PATENTS: Our equipment may be covered by one or more patents. Please go to the following web page for an up-to-date patent list: www.atlatt.com/patents.php
© 2018 Atlanta Attachment Co. 19151080719

362 Industrial Park Drive
Lawrenceville, GA 30046 USA
+1 (770) 963-7369 • FAX +1 (770) 963-7641



Atlanta Attachment Company

The Company that
Sudden Service
built

Images may include options.

Thermo-Label Transfer

- Transfer of thermo-labels to woven and non-woven materials by reel-to-reel technology
- Simple operation and maximum safety
- Photo sensory locating control guarantees optimal accuracy for positioning of labels
- Change out time for tool and die are reduce to a minimum
- Pneumatic electronic temperature and application time controllers ensure a proper adjustment to the decal and material specifications
- The machines design allows use of diverse stationary and sliding tables

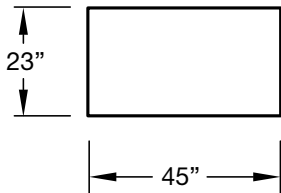

Footprint

SPECIFICATIONS / ESPECIFICACIONES	
Voltage (v/ph/hz) / Voltaje (v/ph/hz)	220V 1Ph 60Hz
Current (kVA) / Amperaje (kVA)	0.7
Motor type / Tipo de motor	DC 24V
Air pressure (psi) / Presión de aire (psi)	90
Air consumption (cfm) / Consumo de aire (cfm)	.1
Shipping Weight (lbs) / Peso de embarque (lbs)	705
Shipping Dimensions (w//h, Inch) / Dimensiones de embarque (w//h, pulgadas)	40 x 59 x 70

PRODUCTION	
Pieces per Hour (depending on label size and material) / Piezas por hora (dependiendo del tamaño de la etiqueta y del material)	300 - 450

www.atlatt.com • sales@atlatt.com

PATENTS: Our equipment may be covered by one or more patents. Please go to the following web page for an up-to-date patent list: www.atlatt.com/patents.php © 2018 Atlanta Attachment Co. 19151080719

362 Industrial Park Drive
Lawrenceville, GA 30046 USA
+1 (770) 963-7369 • FAX +1 (770) 963-7641



Atlanta Attachment Company

The Company that
Sudden Service
built

Automatic Leg Elastic Hemming Station

Sweat Pant Legs

- DC electronic motor & microprocessor controls
- Automatic start/stop
- High production
- Ergonomic design
- Air assisted folder
- Automatic cut apart
- Eliminates elastic waste
- Most industrial multi-needle sewing machines

DESCRIPTION

An electro-pneumatic device consisting of a variable speed puller, an impact type scissor controlled by a single retro-reflective eye, and a belt conveyor positioned to the side of the presser foot. This unit is designed to automatically cut raw rubber or narrow elastic between garment parts such as sweat pant legs. Automatic start and stop control reduces waste between pieces.

OPERATION

The operator presents the material through a downturn hemmer and under the presser foot. Sewing begins automatically. Each successive part is sewn with minimal gap to reduce elastic or rubber waste. The variable speed puller runs faster than the sewing speed and creates a larger gap. The retro-reflective eye senses the leading edge of each part and automatically cycles the scissor cutter to separate the parts. The side conveyor carries the leading edge to the puller and prevents the gathered material from jamming. The 1536A includes automatic stop and start to minimize elastic between pieces and ergonomically designed tabling for stand-up operation.

Images may include options.

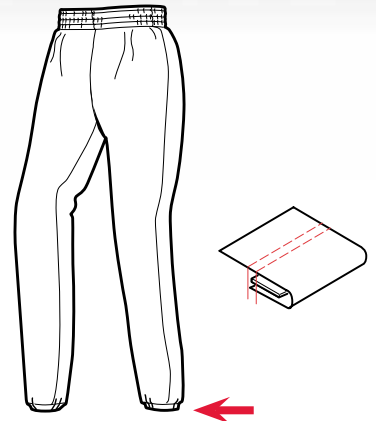

SPECIFICATIONS	
Voltage (v/ph)	220v 1ph
Current (amps)	5
Air pressure (psi)	90
Air consumption (cfm)	9
Shipping weight (lbs)	800
Shipping dimensions (w/l/h, inch)	72 x 46 x 60
PRODUCTION	
Pieces per hour	900

Depending on material and size of parts, one operator can maintain multiple workstations, up to 5

www.atlatt.com • sales@atlatt.com

PATENTS: Our equipment may be covered by one or more patents. Please go to the following web page for an up-to-date patent list: www.atlatt.com/patents.php © 2018 Atlanta Attachment Co. 19151080719

362 Industrial Park Drive
Lawrenceville, GA 30046 USA
+1 (770) 963-7369 • FAX +1 (770) 963-7641



Atlanta Attachment Company
The Company that
Sudden Service
built

Automatic Waistband Station

Jeans, Casual Slacks

An electronically controlled, electro-pneumatic operated device designed to produce finished waistbands with the band ends unsewn and cut to precise length. This station consists of a multi - needle sewing machine*, an auxiliary power feed package, pneumatic safety knife, and control package including electronic motor and automatic waistband measuring capability.

- Increased production
- Lower operator skill
- Consistent high quality
- Automatic waistband measurement
- Precise band end trim
- No stitch ripping at closing band ends
- Most industrial multi-needle sewing machines

OPERATION

The operator inserts the garment into the folded band and up to a mark on the throat plate which closes the leading edge sensor. Depressing the sew treadle begins the sewing and the stitch count. When the preset number of stitches are sewn the machine is automatically stopped while the safety knife trims the band. Sewing then continues under operator control until the trailing edge of the garment is sensed. The trailing edge sensor automatically stops the sewing, actuates the under-trimmer (lockstitch machines), lifts the presser foot and engages the auxiliary power feed to draw the garment and banding to the precise point of end trim. A three digit counter may be set for the desired waistband size and a digital readout is illuminated during sew. This will energize indicator lights if the finished garment is not in tolerance.

Images may include options.

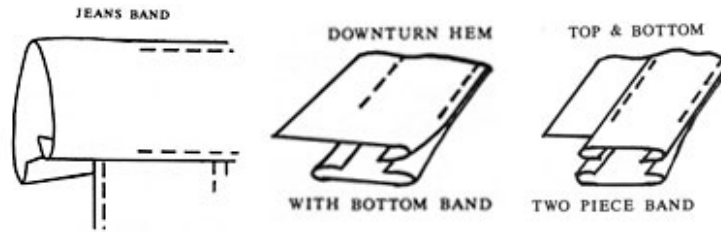

www.atlatt.com • sales@atlatt.com

PATENTS: Our equipment may be covered by one or more patents. Please go to the following web page for an up-to-date patent list: www.atlatt.com/patents.php
© 2018 Atlanta Attachment Co. 19151080719

362 Industrial Park Drive
Lawrenceville, GA 30046 USA
+1 (770) 963-7369 • FAX +1 (770) 963-7641



Atlanta Attachment Company

The Company that
Sudden Service
built

Automatic Collar & Waistband Workstation

- Accepts 2¼" to 8" wide acrylic, woven or rib knit material
- Accepts 15" to 50" long (7 ½" to 25" folded) bands
- Controls trim-off of ¼" to 1/8"
- Stacker automatically indexes by number of pieces programmed
- System automatically stops after number of programmed bundles are completed or material supply is depleted
- Changeover time approx. 30 seconds, by the operator
- Will accommodate roll or festooned materials
- Only one operator is required for each 5 to 7 machines
- Cutting accuracy within 1/8" of programmed length
- Cut length is programmable in 1/10" increments
- Includes thread break detectors
- Electronic DC motor and controls
- Seam ply alignment within 1/8" obtainable

DESCRIPTION

This workstation automatically meters, cuts, sews and stacks programmed lengths of cuff, collar and waistband material, requiring only part-time attendance.

OPERATION

The operator loads rolled or festooned rib knit, programs the desired length, and starts the machine. The material is metered, cut, sewn, and stacked automatically. Each band size can be individually programmed for the number of pieces in the stack, then automatically indexed.

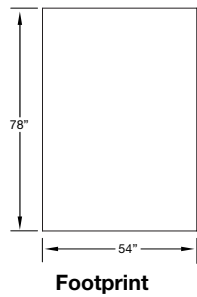

Images may include options.

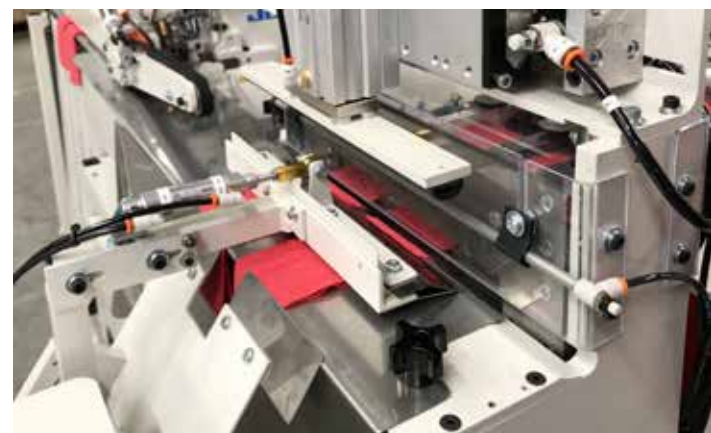

SPECIFICATIONS	
Voltage (v/ph/hz)	220v 1ph
Current (amps)	5
Air pressure (psi)	90
Air consumption (cfm)	10
Shipping weight (lbs)	1100
Shipping dimensions (w/l/h, inch)	96 x 55 x 60
PRODUCTION	
Pieces per hour	487

Estimate based on cycle time, material changeover, & machine program time.

www.atlatt.com • sales@atlatt.com

PATENTS: Our equipment may be covered by one or more patents. Please go to the following web page for an up-to-date patent list: www.atlatt.com/patents.php
 © 2018 Atlanta Attachment Co. 19151080719

362 Industrial Park Drive
 Lawrenceville, GA 30046 USA
 +1 (770) 963-7369 • FAX +1 (770) 963-7641



Atlanta Attachment Company
 The Company that
Sudden Service
 built

Automatic Set-In Pocket Workstation

Set-in Pockets for Sweat Pants & Knit Shorts

- Simultaneous loading & sewing overlapping operation
- DC electronic motor & microprocessor controls
- Automatic sizing
- Automatic under-trimming
- Automatic stacking
- Quality pockets
- Mitsubishi LT2-2230, Juki 1152

DESCRIPTION

An automatic station consisting of two-needle lockstitch sewing head with under-trimmer and programmable center knife gauge set. This unit features electronic controls and automatic garment transfer which allows simultaneous loading and sewing.

OPERATION

The part to be sewn is positioned to laser target lights. The pocketing is then laid on top of the panel and positioned to another set of lights. Depressing the start switch activates the automatic cycle which transfers the parts to the sewing machine. The parts are then sewn, the thread is trimmed and the completed panel is stacked. The operator loads subsequent pieces during the sew cycle.

Images may include options.

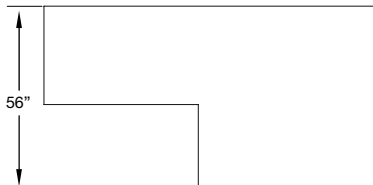
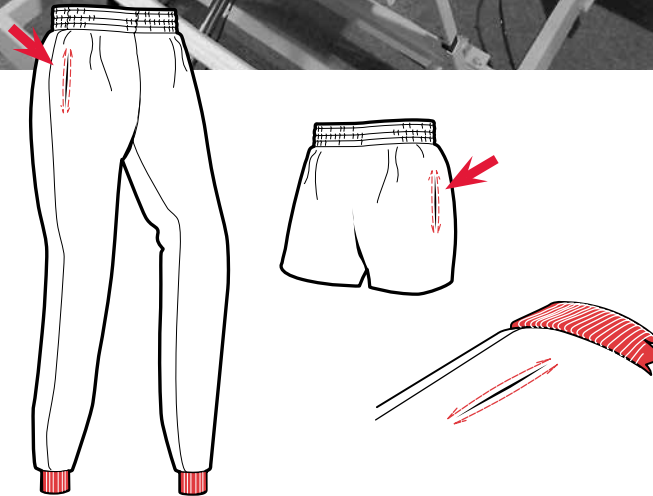

Footprint

SPECIFICATIONS

Voltage (v/ph/hz)	220v 1ph
Current (amps)	5
Air pressure (psi)	90
Air consumption (cfm)	8.5
Shipping weight (lbs)	1300
Shipping dimensions (w/l/h, inch)	120 x 48 x 60
PRODUCTION	
Pieces per hour	360

Depending on material and size of parts

www.atlatt.com • sales@atlatt.com

PATENTS: Our equipment may be covered by one or more patents. Please go to the following web page for an up-to-date patent list: www.atlatt.com/patents.php
© 2018 Atlanta Attachment Co. 19151080719

362 Industrial Park Drive
Lawrenceville, GA 30046 USA
+1 (770) 963-7369 • FAX +1 (770) 963-7641



Atlanta Attachment Company

The Company that
Sudden Service
built

Automatic Rib Knit Cuff Setting Station

- DC electronic motor & controls
- Automatic start and stop
- Automatic cut-apart
- Microprocessor controlled
- Electronic metering - upper or lower
- Minimal rib knit waste
- Automatic stacker with bundle return
- Automatic piece counter
- All industrial safety stitch, overlock or coverstitch machines.

DESCRIPTION

An electronically controlled cuff setting station, this unit is designed to form rib knit tape up to 8 inches wide into a cuff band and sew the band onto the sleeves. The station consists of a sewing head and power console, electronic metering device, automatic cut-apart knife, upper conveyor with automatic stacker, and an inclined bundle return conveyor. A preloading conveyor is used in conjunction with lower metering. Rolled or festooned rib knit tape may be fed from top or bottom.

OPERATION

The sewing cycle and rib knit metering begins automatically by photo cell and continues as the operator presents the sleeves to the machine. As the photo cell senses the trailing edge, the sleeves are automatically cut apart and stacked on an inclined conveyor. At the completion of the bundle, a foot switch is pressed to return the bundle to the operator or the next operation. When the operator discontinues or slows down the loading process, the system automatically stops to maintain the predetermined distance between the parts and save rib knit. The AP23 will accommodate rolled or festooned rib knit, metered from the bottom or top. The electronic metering system ensures consistent quality and repeatability of operation.

OPTIONS

- Upper rib metering
- Lower rib metering

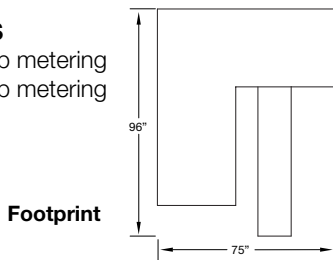

Images may include options.



Upper metering



Lower metering

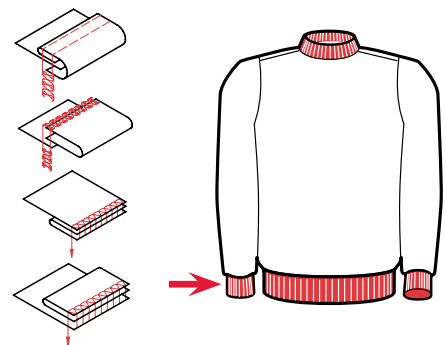

SPECIFICATIONS

Voltage (v/ph/hz)	220v 1ph
Current (amps)	10
Air pressure (psi)	90
Air consumption (cfm)	14
Shipping weight (lbs)	890
Shipping dimensions (w/l/h, inch)	60 x 65 x 60
PRODUCTION	
Pieces per hour	2500-3000 Upper
Pieces per hour	1500 Lower

Depending on material and size of parts

www.atlatt.com • sales@atlatt.com

PATENTS: Our equipment may be covered by one or more patents. Please go to the following web page for an up-to-date patent list: www.atlatt.com/patents.php
© 2018 Atlanta Attachment Co. 19151080719

362 Industrial Park Drive
Lawrenceville, GA 30046 USA
+1 (770) 963-7369 • FAX +1 (770) 963-7641



Atlanta Attachment Company

The Company that
Sudden Service
built

Automatic Rib Knit Leg Cuff Setting Station

Leg Cuffing

- DC electronic motor & microprocessor controls
- Available for overlock & coverstitch machines
- Auto start/stop
- Auto cut-apart
- Minimal rib knit waste
- Electronic metering
- Automatic piece counting
- Available for most industrial overlock & coverstitch machines

DESCRIPTION

An electronically controlled leg cuff setting station. This unit is designed to form rib knit tape up to 8 inches wide into a cuff band and sew the band onto the legs. The station consists of a sewing head and power console, electronic metering device, automatic cut-apart knife, tandem variable speed pullers and ergonomic tabling with pneumatic bundle clamp.

OPERATION

The sewing cycle and rib knit metering begins automatically by photo cell and continues as the operator presents the leg panels to the machine. As the photo cell senses the trailing edge, the legs are automatically cut-apart as they fall behind the machine. The bundle integrity is maintained by the pneumatic bundle clamp. When the operator discontinues or slows down the loading process, the system automatically stops to maintain the predetermined distance between the parts and save rib knit. The electronic metering system ensures consistent quality and repeatability of operation.

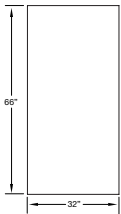

Footprint

Images may include options.

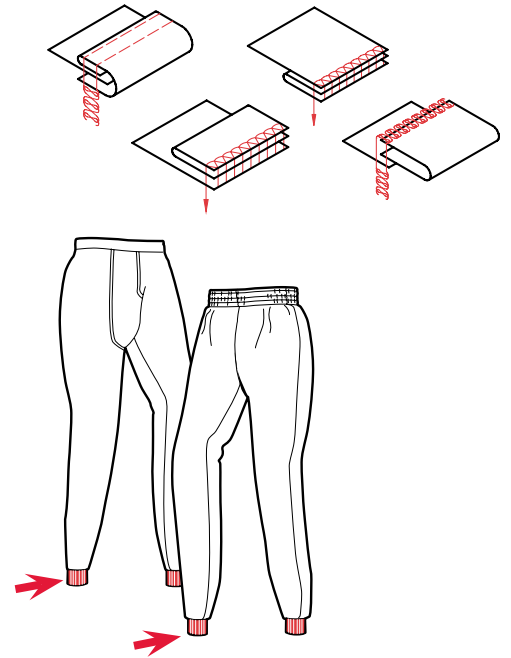
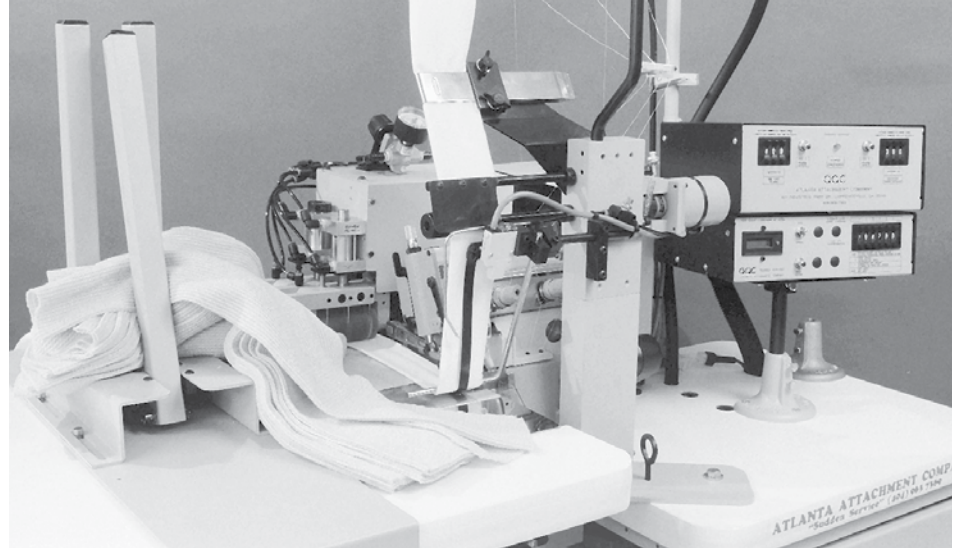

SPECIFICATIONS	
Voltage (v/ph/hz)	220v 1ph
Current (amps)	5
Air pressure (psi)	90
Air consumption (cfm)	10
Shipping weight (lbs)	700
Shipping dimensions (w/l/h, inch)	72 x 48 x 53
PRODUCTION	
Pieces per hour with overlock sewing head	1230

Depending on material and size of parts

www.atlatt.com • sales@atlatt.com

PATENTS: Our equipment may be covered by one or more patents. Please go to the following web page for an up-to-date patent list: www.atlatt.com/patents.php © 2018 Atlanta Attachment Co. 19151080719

362 Industrial Park Drive
Lawrenceville, GA 30046 USA
+1 (770) 963-7369 • FAX +1 (770) 963-7641



Atlanta Attachment Company

The Company that
Sudden Service
built

Images may include options.

Semi-Automatic Sleeve Closing Workstation

- Low cost
- Easy to maintain
- Auto start
- Auto backlatch
- Auto thread cutter
- DC electronic motor & microprocessor controls
- Auto thread saver
- Auto stacker
- Most industrial overlock machines

DESCRIPTION

An electronically controlled sleeve closing station with automatic backlatch designed to close short sleeves.

OPERATION

The operator folds the sleeve and presents it to the presser foot. A photo cell senses the beginning edge, drops the presser foot and begins the sew cycle with an automatic backlatch. When the seam is completed, the machine stops, the thread chain is cut and the sleeve is stacked automatically.

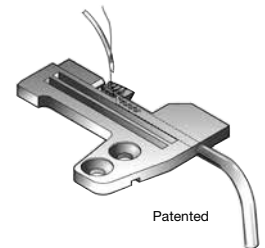
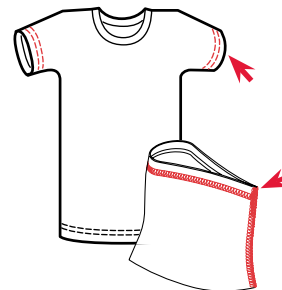
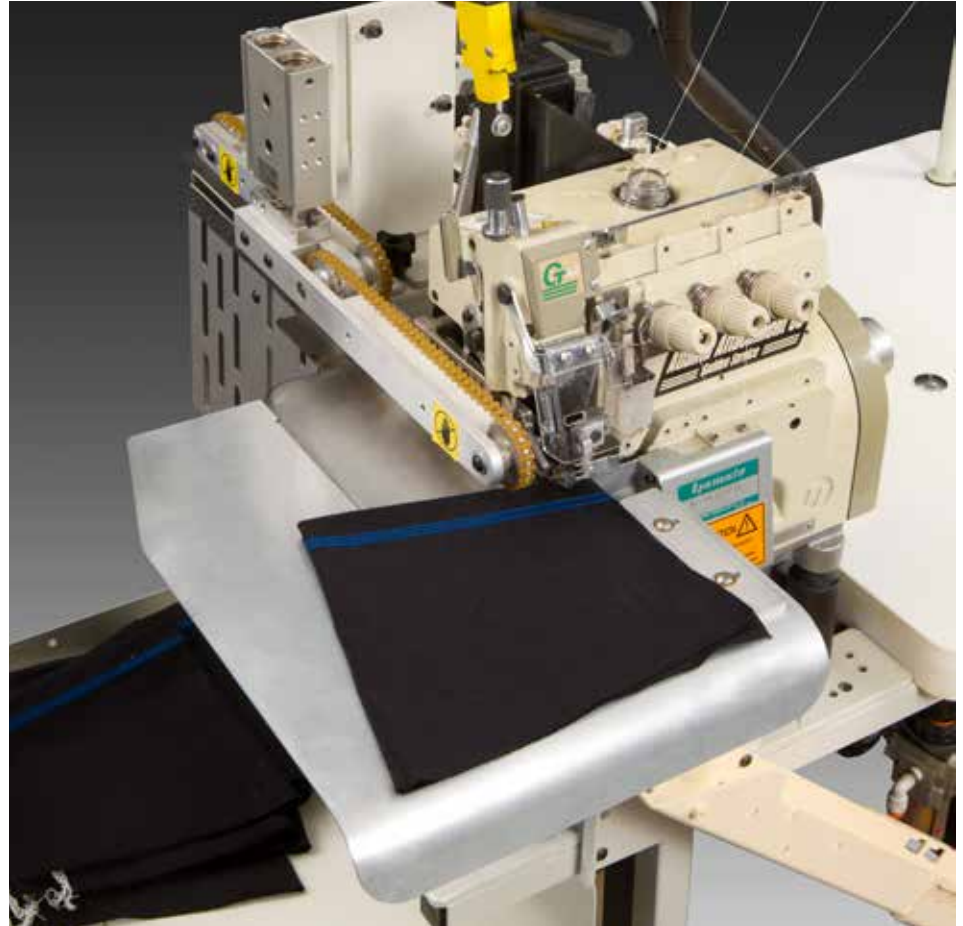

Footprint

SPECIFICATIONS	
Voltage (v/ph/hz)	220v 1ph
Current (amps)	5
Air pressure (psi)	90
Air consumption (cfm)	7
Shipping weight (lbs)	700
Shipping dimensions (w/l/h, inch)	60 x 46 x 53
PRODUCTION	
Pieces per hour	1080

Depending on material and size of parts

www.atlatt.com • sales@atlatt.com

PATENTS: Our equipment may be covered by one or more patents. Please go to the following web page for an up-to-date patent list: www.atlatt.com/patents.php
© 2018 Atlanta Attachment Co. 19151080719

362 Industrial Park Drive
Lawrenceville, GA 30046 USA
+1 (770) 963-7369 • FAX +1 (770) 963-7641



Atlanta Attachment Company

The Company that
Sudden Service
built

Automatic Short Sleeve Closing Workstation

- Auto start
- Auto bundle return
- Auto backlatch
- Auto thread cutter
- Patented Serial Bus Control System
- Electronic active edge guiding system
- Auto thread saver
- Auto piece counter
- Auto stacker
- Most industrial overlock machines

DESCRIPTION

An electronically controlled sleeve closing station with automatic backlatch designed to close short sleeve tee shirt sleeves. This unit includes our exclusive electronic active edge guiding system, providing the capability to sew either straight or contoured seams.

OPERATION

The operator folds the sleeve and presents it to the presser foot. A photo cell senses the beginning edge, drops the presser foot and begins the sew cycle with an automatic backlatch. The electronic active edge guiding system controls the sleeve during sewing, while the operator prepares the next sleeve. When the seam is completed, the machine stops, the thread chain is cut and the sleeve is stacked automatically. Stacker selection is available for either single or double stack.

Images may include options.

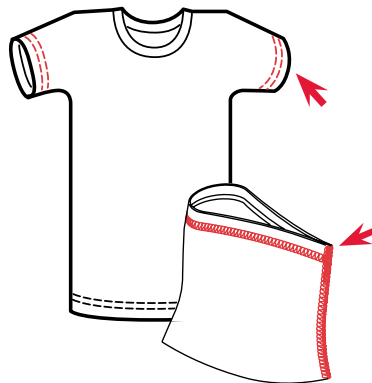

Patented Serial Bus Control System

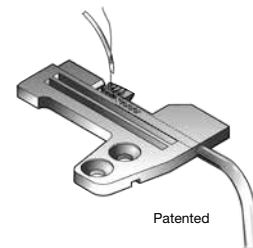

Patented

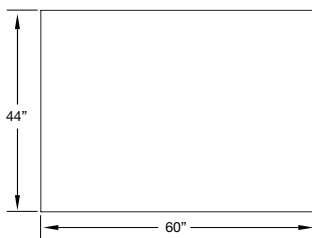

Footprint

SPECIFICATIONS

Voltage (v/ph/hz)	220v 1ph
Current (amps)	5
Air pressure (psi)	90
Air consumption (cfm)	12
Shipping weight (lbs)	1350
Shipping dimensions (w/l/h, inch)	60 x 60 x 65
PRODUCTION	
Pieces per hour	1080

Depending on material and size of parts

www.atlatt.com • sales@atlatt.com

PATENTS: Our equipment may be covered by one or more patents. Please go to the following web page for an up-to-date patent list: www.atlatt.com/patents.php
© 2018 Atlanta Attachment Co. 19151080719

362 Industrial Park Drive
Lawrenceville, GA 30046 USA
+1 (770) 963-7369 • FAX +1 (770) 963-7641



Atlanta Attachment Company

The Company that
Sudden Service
built

Automatic Long Sleeve Closing Workstation

- Auto start & stop
- Auto bundle return
- Auto backlatch
- Auto thread cutter
- Patented Serial Bus Control System
- Electronic active edge guiding system
- Auto thread saver
- Auto piece counter
- Auto stack
- Short or long sleeves
- Most industrial overlock machines

DESCRIPTION

An electronically controlled sleeve closing station with automatic backlatch designed to close jersey or fleece, short or long sleeves. This unit includes electronic active edge guiding system, providing the capability to sew either straight or contoured seams.

OPERATION

The operator folds the sleeve, aligning the hemmed or cuffed end and presents it to the presser foot. A photo cell senses the beginning edge, drops the presser foot and begins the sew cycle with an automatic backlatch. The electronic active edge guiding system controls the sleeve during sewing cycle, while the operator prepares the next sleeve. When the seam is completed, the machine stops, the thread chain is cut and the sleeve is stacked automatically.

OPTIONS

Indexing bundle table

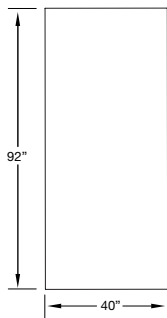

Footprint

Images may include options.

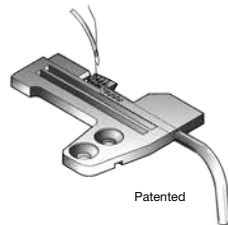
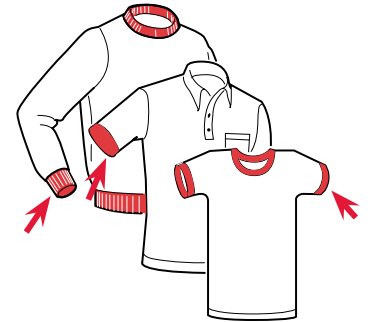

Patented

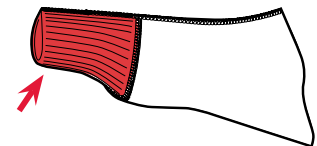

SPECIFICATIONS

Voltage (v/ph/hz)	220v 1ph
Current (amps)	5
Air pressure (psi)	90
Air consumption (cfm)	13
Shipping weight (lbs)	1200
Shipping dimensions (w/l/h, inch)	96 x 72 x 53

PRODUCTION

Short sleeves per hour	1080
Long fleece sleeves per hour	1260
Long jersey sleeve per hour	720

Depending on material and size of parts

www.atlatt.com • sales@atlatt.com

PATENTS: Our equipment may be covered by one or more patents. Please go to the following web page for an up-to-date patent list: www.atlatt.com/patents.php © 2018 Atlanta Attachment Co. 19151080719

362 Industrial Park Drive
Lawrenceville, GA 30046 USA
+1 (770) 963-7369 • FAX +1 (770) 963-7641



Atlanta Attachment Company

The Company that
Sudden Service
built

Automatic Long Sleeve Close and Turn Workstation

- DC electronic motor & microprocessor controls
- Automatic start & stop
- Electronic active edge guiding system
- Automatic backlatch
- Automatic sleeve turner
- Automatic thread cutter
- Automatic piece counter
- Automatic stacker
- Most industrial overlock machines

DESCRIPTION

An electronically controlled sleeve closing and turning station with automatic backlatch. This unit includes electronic active edge guiding system, providing the capability to sew either straight or contoured seams.

OPERATION

The operator folds the sleeve, aligning the hemmed or cuffed end and presents it to the presser foot. A photo cell senses the beginning edge, drops the presser foot and begins the sew cycle with an automatic backlatch. The electronic active edge guiding system controls the sleeve during the sew cycle, while the operator prepares the next sleeve. When the seam is completed, the thread chain is cut, the sleeve is turned and stacked automatically.

Images may include options.

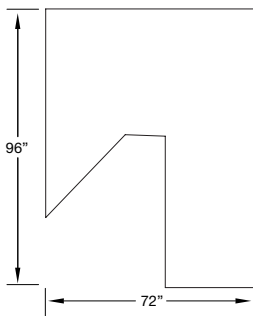
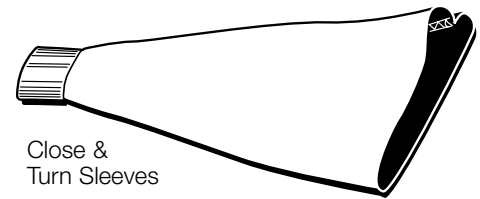
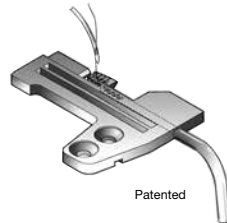

Footprint

SPECIFICATIONS

Voltage (v/ph/hz)	220v 1ph
Current (amps)	10
Air pressure (psi)	90
Air consumption (cfm)	9
Shipping weight (lbs)	1500
Shipping dimensions (w/l/h, inch)	96 x 75 x 60

PRODUCTION

Long fleece sleeves per hour	660
Long jersey sleeve per hour	540

Depending on material and size of parts

www.atlatt.com • sales@atlatt.com

PATENTS: Our equipment may be covered by one or more patents. Please go to the following web page for an up-to-date patent list: www.atlatt.com/patents.php © 2018 Atlanta Attachment Co. 19151080719

362 Industrial Park Drive
Lawrenceville, GA 30046 USA
+1 (770) 963-7369 • FAX +1 (770) 963-7641



Atlanta Attachment Company

The Company that
Sudden Service
built

Automatic Leg Closing Workstation

- Patented Serial Bus Control System
- Automatic start & stop
- Electronic active edge guiding system
- Automatic backlatch
- Automatic thread cutter
- Automatic piece counter
- Automatic stacker
- Sews hemmed elastic and cuffed legs
- Most industrial overlock machines

DESCRIPTION

An electronically controlled leg closing workstation with automatic backlatch. This unit includes electronic active edge guiding system, providing the capability to sew either straight or contoured seams.

OPERATION

The operator folds the pant leg, aligns the hemmed or cuffed end and presents it to the presser foot. A photo cell senses the leading edge, drops the presser foot and begins the sewing cycle with a backlatch automatically. Electronic active edge guiding system controls the part during the sew cycle while the operator prepares the next pant leg. When the seam is complete, the machine stops, the thread chain is cut and stacked automatically.

Images may include options.

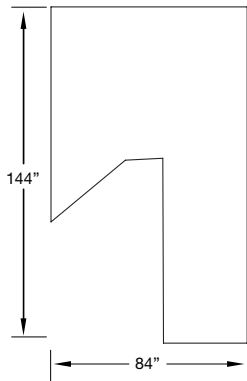
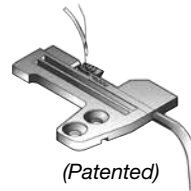
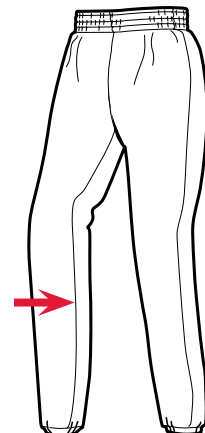

Footprint

SPECIFICATIONS	
Voltage (v/ph/hz)	220v 1ph
Current (amps)	10
Air pressure (psi)	90
Air consumption (cfm)	13
Shipping weight (lbs)	1500
Shipping dimensions (w/l/h, inch)	120 x 60 x 65
PRODUCTION	
Pieces per hour	600

Depending on material and size of parts

www.atlatt.com • sales@atlatt.com

PATENTS: Our equipment may be covered by one or more patents. Please go to the following web page for an up-to-date patent list: www.atlatt.com/patents.php © 2018 Atlanta Attachment Co. 19151080719

362 Industrial Park Drive
Lawrenceville, GA 30046 USA
+1 (770) 963-7369 • FAX +1 (770) 963-7641



Atlanta Attachment Company

The Company that
Sudden Service
built

Images may include options.

Velcro Feeder

- Easy length adjustments
- Consistent feeding
- Manual or Automatic loading
- Can be installed on many types of cycle sewing machine

Automatic cut and sew of Velcro material. Bottom or Top feed. JA-042E Velcro Feeder is capable of cutting and loading Velcro from 3/8" x 2 1/2" width to 1" x 6" length. The lower nest is adjustable to accept any size Velcro in this range. The top clamp is fixed in width and adjustable in length.

Automatic cut and sew of Velcro "hook and loop"

FEATURES

Length:

(min) 25.4 mm / 1"

(max) 150 mm / 6"

Width:

(min) 10 mm / 3/8"

(max) 64 mm / 2 1/2"



SPECIFICATIONS

Voltage (v/ph/hz)	220v 1ph
Current (amps)	5
Air pressure (psi)	90
Air consumption (cfm)	2

www.atlatt.com • sales@atlatt.com

PATENTS: Our equipment may be covered by one or more patents. Please go to the following web page for an up-to-date patent list: www.atlatt.com/patents.php
© 2018 Atlanta Attachment Co. 19151080719

362 Industrial Park Drive
Lawrenceville, GA 30046 USA
+1 (770) 963-7369 • FAX +1 (770) 963-7641



Atlanta Attachment Company

The Company that
Sudden Service
built

ATTACHMENTS, FOLDERS and OTHER

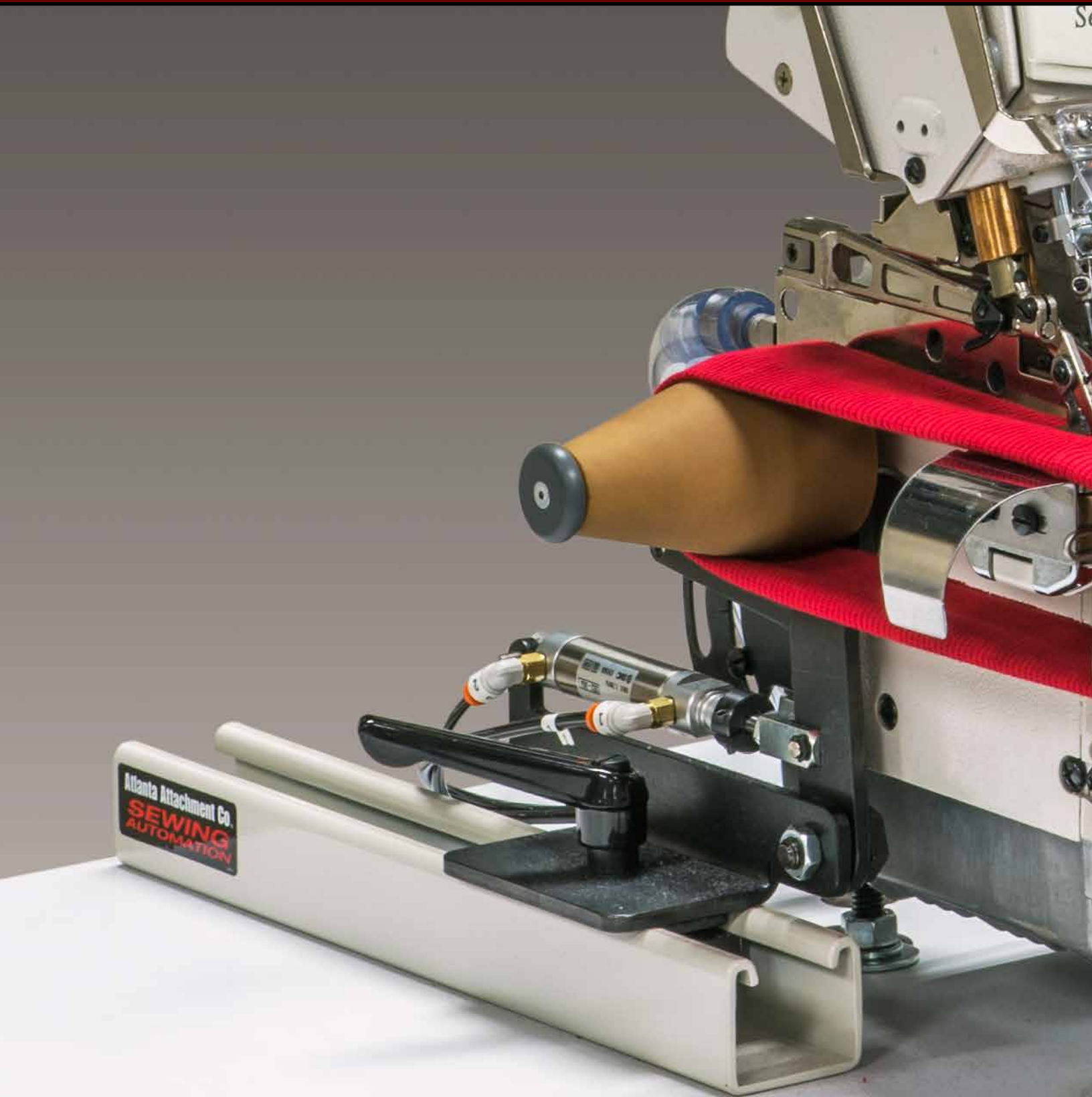

EQUIPMENT

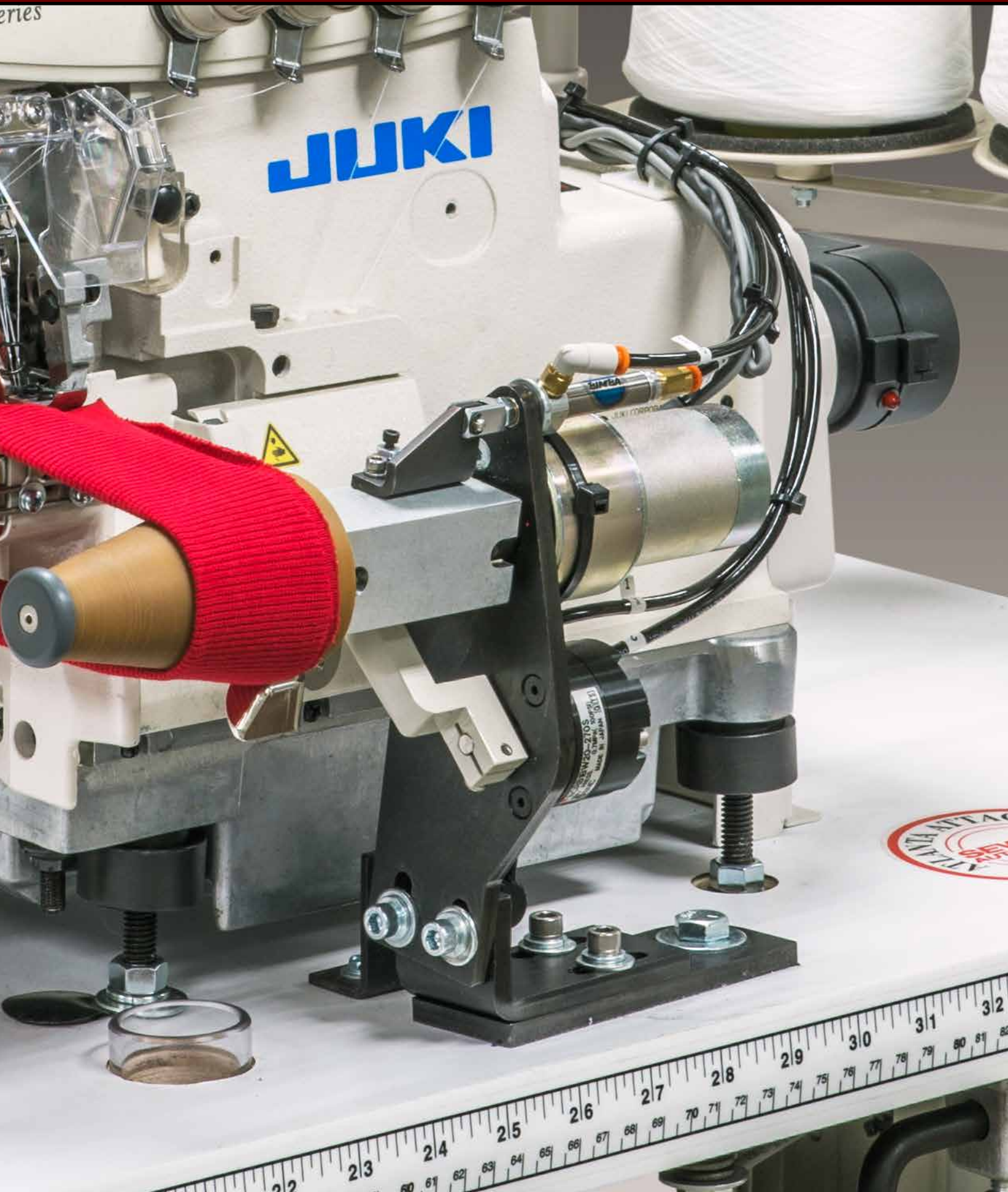

Images may include options.

Fashion Collar Setting and Taping

Placket Shirts

Set Collar and Tape in One Operation

A pneumatically controlled collar taping folder designed to shift to the left to insert the tape under the presser foot. Upon signal, the folder shifts to the right to allow the tape to be cut by the edge trimming knife. The tape does not extend to the edge of the placket on either end. Therefore, when the placket is turned, there is no bulk or additional thickness. This improves the overall appearance and reduces problems in the buttonhole and button sew operations.

OPERATION

The collar is aligned to the shirt body. The placket is folded over the leading edge of the collar and placed under the foot. The pieces are sewn approximately 1/2" and a touch of the knee switch shifts the folder to the left and taping starts. As the trailing edge of the collar nears the machine, the operator folds the placket over the collar and touches the knee switch. At this point the folder shifts to the right and the tape is cut by the edge trimming knife.

OPTIONS

- Patented roller presser foot
- Automatic foot lift

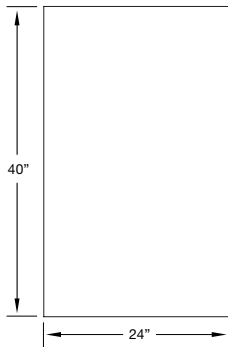
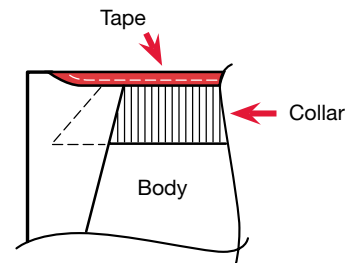
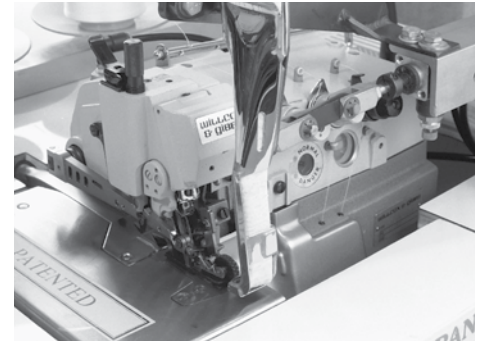

Footprint

SPECIFICATIONS

Voltage (v/ph/hz)	220v 1ph
Current (amps)	5
Air pressure (psi)	90
Air consumption (cfm)	2
PRODUCTION	
Pieces per hour	165-175

Depending on material and size of parts

www.atlatt.com • sales@atlatt.com

PATENTS: Our equipment may be covered by one or more patents.
 Please go to the following web page for an up-to-date patent list: www.atlatt.com/patents.php
 © 2018 Atlanta Attachment Co. 19151080719

362 Industrial Park Drive
 Lawrenceville, GA 30046 USA
 +1 (770) 963-7369 • FAX +1 (770) 963-7641



Atlanta Attachment Company

The Company that
Sudden Service
 built

Circular Collar Setting and Taping

A pneumatically controlled set of rollers & taping folder designed to apply tape to a circular knit collar while the collar is being sewn to the shirt.

- Set and tape circular knit collars in one operation
- Tape shoulder seam to shoulder seam only
- No production loss at collar setting
- Top-stitch at final operation allows shirt to be finished, folded, warehoused and labeled as sold
- Pneumatic operation
- Simple in-house installation
- Most industrial cylinder arm machines

OPERATION

Heel the treadle to raise the presser foot – load the circular collar over the rollers and under the foot – load the shirt over the rollers and under the foot. A touch of the knee switch shifts the folder to the left and expands the rollers bringing the tape in line with the presser foot. Drop the foot and sew – approximately 1" from the shoulder seam the folder is shifted to the right by depressing the knee switch – continuation of sew will allow the tape to be cut by the edge trimming knife – this produces a neat rounded finish on the tape. The tape may be inserted or retracted at any point in the operation.

Note: The 273-37S operates the same as the 273-37 except the rollers, while adjustable for size, do not expand or retract pneumatically.

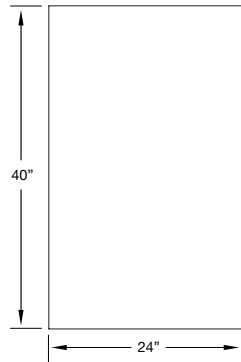

Footprint

Images may include options.

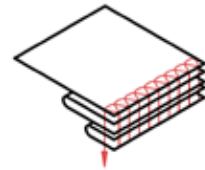

SPECIFICATIONS

Voltage (v/ph/hz)	220v 1ph
Current (amps)	5
Air pressure (psi)	90
Air consumption (cfm)	2
PRODUCTION	
Pieces per hour	165-175

Depending on material and size of parts

www.atlatt.com • sales@atlatt.com

PATENTS: Our equipment may be covered by one or more patents. Please go to the following web page for an up-to-date patent list: www.atlatt.com/patents.php © 2018 Atlanta Attachment Co. 19151080719

362 Industrial Park Drive
Lawrenceville, GA 30046 USA
+1 (770) 963-7369 • FAX +1 (770) 963-7641



Atlanta Attachment Company

The Company that
Sudden Service
built

Images may include options.

Clean Finish Elastic Waistband Station

An electro-pneumatic clean finish waistband station consisting of a multi needle sewing machine*, motor, stand, spiral elastic guide (350-12), three blade rotary knife (for cut apart) and variable speed conveyor and metering device.

- Electric eye start
- Minimizes C.T.D. risk
- Improves quality
- Increases production
- Accurate sizing
- Reduce elastic waste
- Automatic cut apart
- Easy operation
- Minimize training
- Seams go through without hanging
- All industrial multi needle chain stitch machines. (Special gauge parts are available.)
- Sewing head provided by customer

OPERATION

The operator presents the flat garment to the edge guide and into the spiral folder. An electric eye senses the leading edge and starts the sew cycle. The operator holds the garment against the edge guide until completely into the folder. The electric eye senses the trailing edge and stops the sew cycle leaving the proper spacing for the next garment to eliminate waste. The operator then picks up the next garment and repeats, the conveyor will carry pieces to the knife for automatic cut apart and then to the disposal area.

OPTIONS

Components may be purchased separately
 Spiral elastic guide and folder
 Variable speed metering device
 Three blade knife (cut apart)
 Conveyor stand length 40" (60" available)
 Thread break detectors
 Elastic detectors

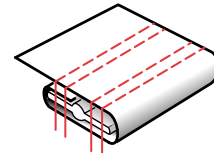
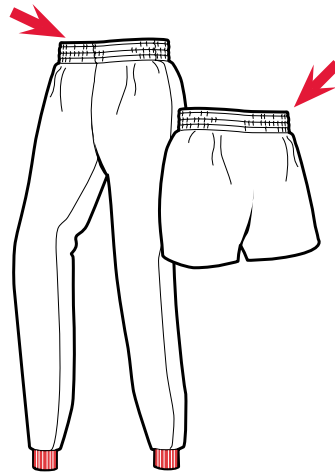
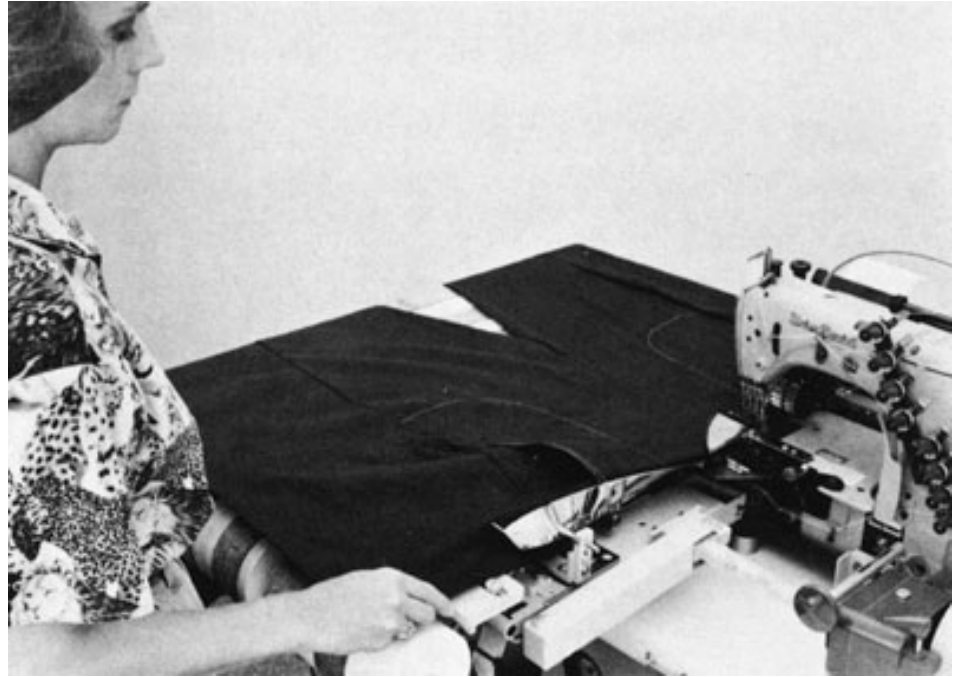

With or without quick cord

SPECIFICATIONS	
Voltage (v/ph/hz)	220v 1ph
Current (amps)	5
Air pressure (psi)	90
Air consumption (cfm)	2

www.atlatt.com • sales@atlatt.com

PATENTS: Our equipment may be covered by one or more patents.
 Please go to the following web page for an up-to-date patent list: www.atlatt.com/patents.php
 © 2018 Atlanta Attachment Co. 19151080719

362 Industrial Park Drive
 Lawrenceville, GA 30046 USA
 +1 (770) 963-7369 • FAX +1 (770) 963-7641



Atlanta Attachment Company

The Company that
Sudden Service
 built

Clean Finish Elastic Waistband Spiral Folder

A manually operated patented spiral folder for producing clean finish elastic waistbands up to 1.5" wide. Unit comes complete with mounting bracket, edge guide and tight finish cap. This unit reduces skill level and training while increasing production and quality. Ergonomic risks associated with normal hemmers are totally eliminated.

- Active wear
- Waistbands
- Children's Pajamas
- Deskills a difficult operation
- Difficult fabrics such as knit or fleece load easily
- With or without quick cord
- Sewing head provided by customer

OPERATION

The folder is loaded with elastic supplied through an electronic metering device. The folder guides the elastic to the sewing machine while turning the elastic 180°. The operator depresses the sew treadle while inserting the garment into the folder at an edge guide which controls the amount of turn under. The elastic feeds the garment through the spiral folder causing a tight, clean finish wrap as the material is sewn.

OPTIONS

- AP28 electronic metering device
- Pneumatic scissor knife

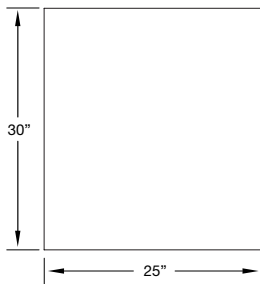

Footprint

Images may include options.

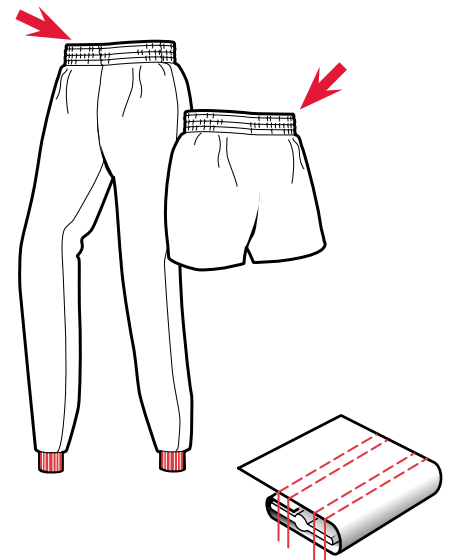
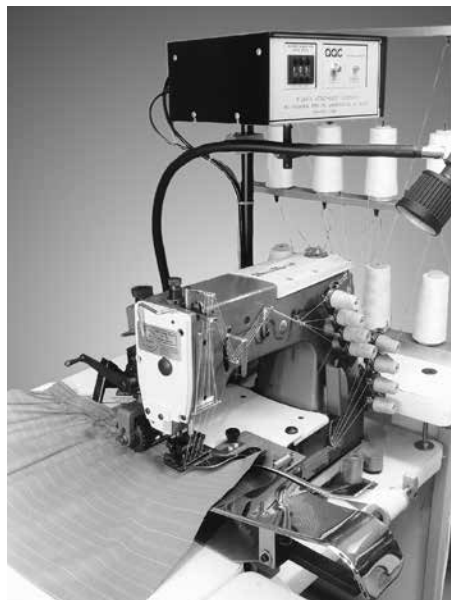
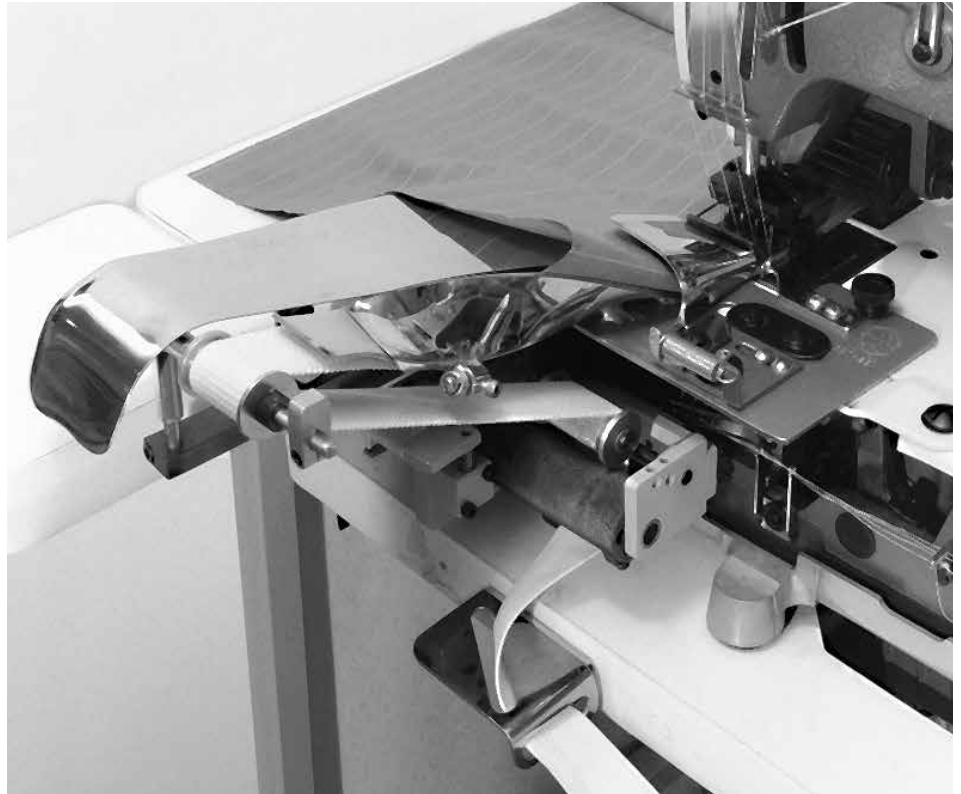

With or without quick cord

SPECIFICATIONS	
Voltage (v/ph/hz)	220v 1ph
Current (amps)	5
Air pressure (psi)	90
Air consumption (cfm)	2

www.atlatt.com • sales@atlatt.com

PATENTS: Our equipment may be covered by one or more patents. Please go to the following web page for an up-to-date patent list: www.atlatt.com/patents.php © 2018 Atlanta Attachment Co. 19151080719

362 Industrial Park Drive
Lawrenceville, GA 30046 USA
+1 (770) 963-7369 • FAX +1 (770) 963-7641



Atlanta Attachment Company

The Company that
Sudden Service
built

Images may include options.

Spot Elastic Waistband

A semi-automatic system designed to produce a spot or partial elastic waistband. The unit consists of upper and lower folders, or upper downturn hemmer and lower cover band folder, elastic feed and tension mechanism, and elastic cutting knife. Elastic may be inserted between two piece waistband or top downturn hemmer and bottom band. Seven different configurations are available.

- Side Spot
- Half Elastic Waistbands
- Eliminates elastic handling
- Cut and reinsert on command
- 3" spot to full back capability
- Adaptable for most machines
- Pneumatic or electronic controls
- Elastic width up to 2"

OPERATION

The operator heels the treadle to lift the presser foot, presents the garment under the foot and sews to a predetermined point (notch, mark, pocket hem, etc.). Pressing the knee switch activates the feed cycle which momentarily lifts the presser foot and tension bar for elastic insertion. As sewing continues the elastic is automatically metered. Continuation of sew draws the elastic from the metering device as the waistband is completed. Side spot of 3" to full pocket-to-pocket elastic is attainable.

OPTIONS

- **AAT301B** Pneumatic cut-apart knife

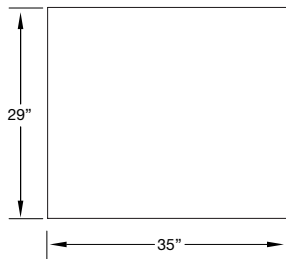
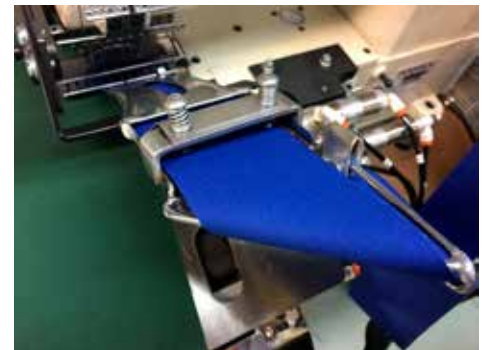

Footprint

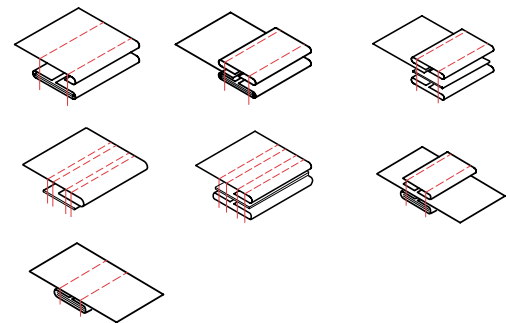
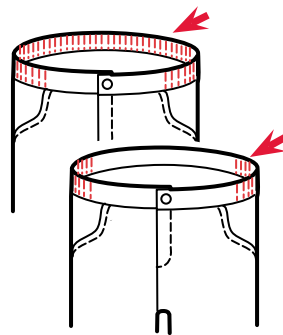

SPECIFICATIONS

Voltage (v/ph/hz)	220v 1ph
Current (amps)	5
Air pressure (psi)	90
Air consumption (cfm)	2

www.atlatt.com • sales@atlatt.com

PATENTS: Our equipment may be covered by one or more patents. Please go to the following web page for an up-to-date patent list: www.atlatt.com/patents.php © 2018 Atlanta Attachment Co. 19151080719

362 Industrial Park Drive
Lawrenceville, GA 30046 USA
+1 (770) 963-7369 • FAX +1 (770) 963-7641



Atlanta Attachment Company

The Company that
Sudden Service
built

Images may include options.

Air Guided Hemmer

Shirts may be tubular or with side seams

- Adjustable from 1/2" (12.7mm.) to 1" (25.4 mm.)
- Requires a electronic motor controller with proper signaling capabilities.
- This unit only adds one inch (25.4 mm.) to the front of any Cylinder bed cover stitch type machine.
- Available for most cylinder arm cover stitch machines.

DESCRIPTION

It is the smallest way to hem bottoms or closed sleeves with or without seams. The remote mounting of the control makes this possible. It is setup with automatic sensing of starting stitches with photoelectric

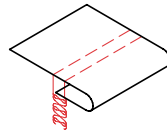

Plain Hem w/Bottom Cover

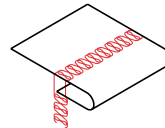

Plain Hem w/Top & Bottom Cover

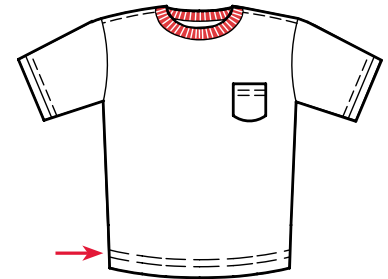

Adult sizes

SPECIFICATIONS	
Voltage (v/ph/hz)	220v 1ph
Current (amps)	5
Air pressure (psi)	90
Air consumption (cfm)	5
PRODUCTION	
Pieces per hour	200-250

Depending on material and size of parts

www.atlatt.com • sales@atlatt.com

PATENTS: Our equipment may be covered by one or more patents. Please go to the following web page for an up-to-date patent list: www.atlatt.com/patents.php © 2018 Atlanta Attachment Co. 19151080719

362 Industrial Park Drive
Lawrenceville, GA 30046 USA
+1 (770) 963-7369 • FAX +1 (770) 963-7641



Atlanta Attachment Company

The Company that
Sudden Service
built

Circular Clean Finish Waistband Station

Circular Clean Finish Waistband Station

An electro-pneumatic device consisting of expansion roller guides, two position folder, power feed package and air control package designed to sew pre-closed elastic loops inside a closed garment to produce a clean finish circular elastic waistband.

- Simple controls
- Low Maintenance
- Ease of operation
- Eliminate bulky seat seam
- Adapts to existing machine
- Reduces operator fatigue
- Reduces skill factor
- Reduces training
- Available with Model 1904 multi
- Needle under trimmer

OPERATION

The pre-sewn elastic loop is inserted inside the closed circular panel to a depth equal to the width of the elastic plus 3/8" to 11/2" for fold under. The operator touches the air foot switch to collapse the guide rollers, heels the sew treadle to lift the presser foot. The garment is inserted over the rear roller, under the foot and over the front roller. Depress the air foot pedal to expand the roller. A touch of the knee switch shifts the clean finish folder to the right and the operator tucks the fold under material with the fingers of the right hand. A touch of the toe switch draws the garment through the folder 5 to 7 inches to assure a clean fold. The garment is sewn to the point where stitching began. A press of the knee switch opens the folder and allows sew over of the starting stitches. Heeling the treadle actuates the under-trimmer and foot-lift*. A touch of the air foot pedal collapses the rollers for unloading.

* Machines without under-trimmer will have foot lift and position only. Optional thread chopper or multi needle under-trimmer available.

Images may include options.

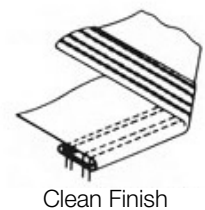
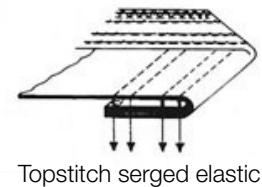

SPECIFICATIONS	
Voltage (v/ph/hz)	220v 1ph
Current (amps)	5
Air pressure (psi)	90
Air consumption (cfm)	2

www.atlatt.com • sales@atlatt.com

PATENTS: Our equipment may be covered by one or more patents.
 Please go to the following web page for an up-to-date patent list: www.atlatt.com/patents.php
 © 2018 Atlanta Attachment Co. 19151080719

362 Industrial Park Drive
 Lawrenceville, GA 30046 USA
 +1 (770) 963-7369 • FAX +1 (770) 963-7641



Atlanta Attachment Company

The Company that
Sudden Service
built

Circular Collar Guiding Attachment

- Easy to adjust
- Unlimited neck sizes
- Consistent edge guide
- Low cost
- Available for all cylinder arm machines

OPERATION

The operator loads the collar onto the rollers which are adjustable for size. After the collar is loaded the shirt is positioned over the collar and sewing cycle begins. The operator may stop to add a label. This device ensures that the collar stretch is evenly distributed around the neck of the shirt. Quality and production is greatly increased.

OPTIONS

- Label holder
- Stationary or pneumatic models
- Label pick-up pneumatic model

Images may include options.

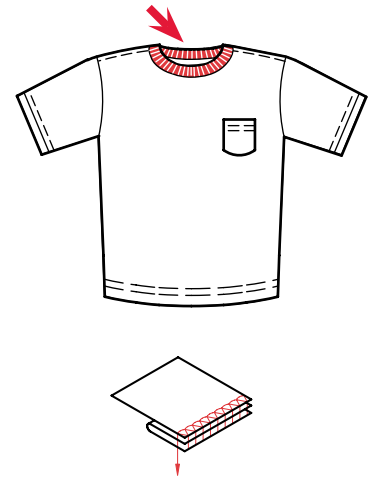

SPECIFICATIONS	
Voltage (v/ph/hz)	220v 1ph
Current (amps)	3
Air pressure (psi)	90
Air consumption (cfm)	2

www.atlatt.com • sales@atlatt.com

PATENTS: Our equipment may be covered by one or more patents. Please go to the following web page for an up-to-date patent list: www.atlatt.com/patents.php
© 2018 Atlanta Attachment Co. 19151080719

362 Industrial Park Drive
Lawrenceville, GA 30046 USA
+1 (770) 963-7369 • FAX +1 (770) 963-7641



Atlanta Attachment Company
The Company that
Sudden Service
built

Automatic Circular Collar Loading Rollers

- Reduces collar loading time 80-90%
- Collar may be tubular or with seams
- Collar seam (if any) is automatically positioned
- Pneumatic rollers eliminate puckers on shirt
- Aligns the collar plies evenly
- These features improve the quality of the shirt and greatly reduce the time required to set the collar
- Available for all model overlock machines with cylinder arm

DESCRIPTION

A pneumatic/electronic set of rollers that automatically loads the collar, aligns the edge, and positions the collar seam (if any). Machine with foot-lift required.

OPERATION

The operator places the collar on the tip of the rollers, heels the treadle and the rollers rotate and expand. The collar moves into position under the foot. If the collar has a seam, it is automatically positioned to align with the shoulder seam in the shirt. The operator picks up the shirt while the collar is automatically loaded and positioned.

OPTIONS

- Label holder
- Label pick-up pneumatic model
- Foot-lift

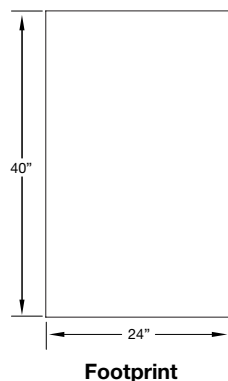

Images may include options.

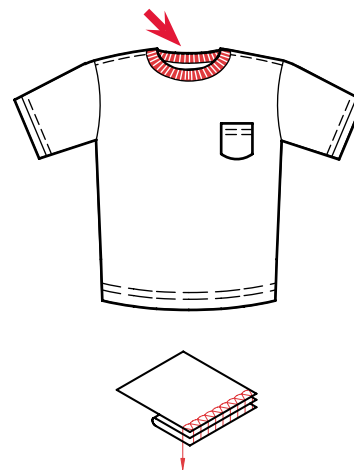
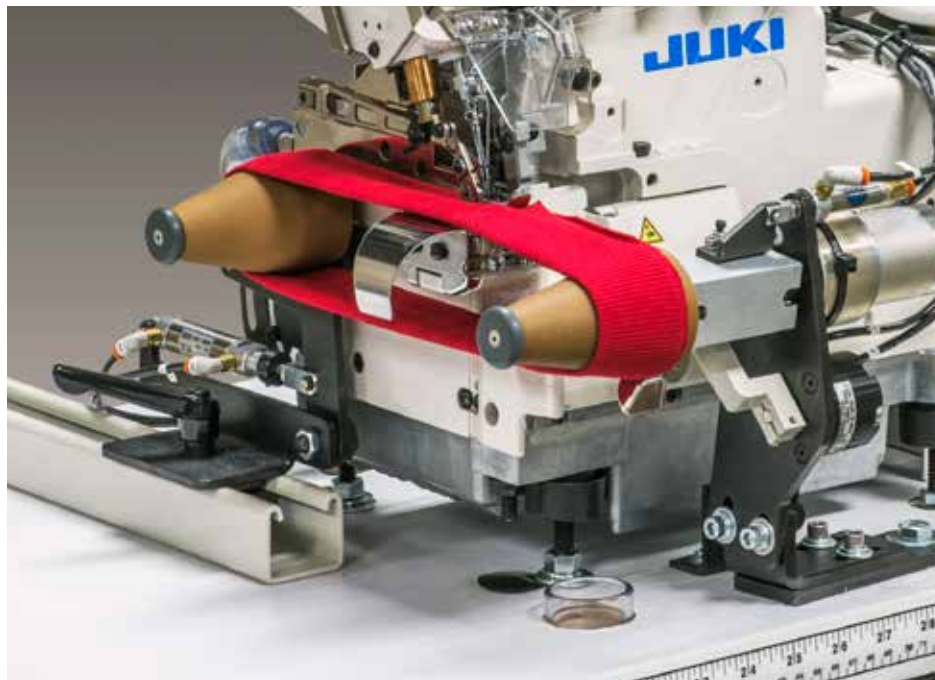

SPECIFICATIONS	
Voltage (v/ph/hz)	220v 1ph
Current (amps)	5
Air pressure (psi)	90
Air consumption (cfm)	2

www.atlatt.com • sales@atlatt.com



Atlanta Attachment Company

The Company that
Sudden Service
 built

Images may include options.

Ruffler

Rufflers for any purpose

- No operator training
- Ruffler arm will not obstruct operator sewing vision
- This unique attachment is retrofit to the following machines:
 - Single Needle
 - Double Needle
 - Multi-Needle
 - Lock-stitch
 - Chain-stitch
 - Overlock
 - Safety-stitch
 - Zig Zag

OPERATION

- Constant Rufflers
- Intermittent Rufflers
- Sandwich Rufflers
- Top Rufflers
- Bottom Rufflers
- Double Blade Rufflers
- Top and Bottom Rufflers
- Edge-To-Edge Rufflers
- Top-stitch Rufflers

OPTIONS

Can be converted from one type ruffler to another without major changes.

See a few of the hundreds of options on the following page. contact a sales representative for info on other options.

NOTE: Machine class and sewn sample or sketch of seam needed for quoting on price and delivery.

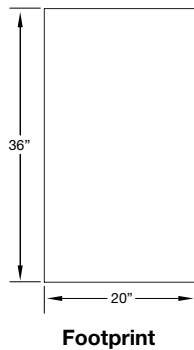

SPECIFICATIONS	
Voltage (v/ph/hz)	220v 3ph
Current (amps)	5
Air pressure (psi)	60
Air consumption (cfm)	2

www.atlatt.com • sales@atlatt.com



Atlanta Attachment Company

The Company that
Sudden Service
built

Images may include options.

High Speed Intermittent Rufflers

- Intermittent all styles
- Operator accessibility, especially on collars and small parts
- 4500 RPM vs 2000 RPM
- Ruffling blade lifter for easier loading of the ply to be ruffled

132521
Intermittent ruffling for sleeve setting



132522
Edge to edge ruffling



132531
Ruffling lace between two plies "sandwich ruffler"



132534
Lace between two ply collar and inserting cord and piping



132535
Cord piping and binding



132536
Intermittent ruffling and binding

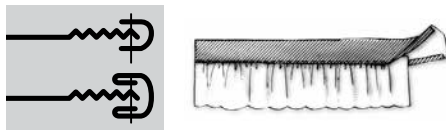

132537
Intermittent ruffling and binding

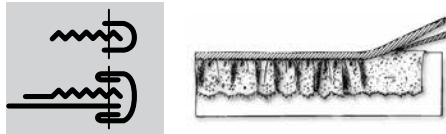

132538
Intermittent lace ruffling and binding



132539
Ballerina ruffler



132544
Three piece topstitch (yoke) ruffler



132545
Three piece topstitch ruffle



132548
Cuffer ruffler



132549
Intermittent ruffling on top of garment (suspended)



132550
Rhumba ruffler



132551
Zig-Zag ruffler (ruffle on the right)



132552
Suspended ruffler

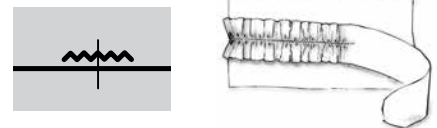

132556B
Two needle ruffling (on plain machine)



132559
Can Can (suspended binder, left side ruffler)

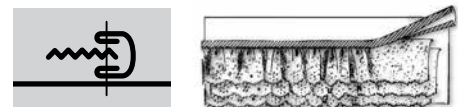

www.atlatt.com • sales@atlatt.com

PATENTS: Our equipment may be covered by one or more patents. Please go to the following web page for an up-to-date patent list: www.atlatt.com/patents.php
© 2018 Atlanta Attachment Co. 19151080719

362 Industrial Park Drive
Lawrenceville, GA 30046 USA
+1 (770) 963-7369 • FAX +1 (770) 963-7641



Atlanta Attachment Company

The Company that
Sudden Service
built

Images may include options.

Vibrating Binder

A mechanically operated device designed to provide an oscillating movement to a right angle binder.

- All industrial flat and cylinder bed machines.

OPERATION:

When sewing stretch binding the unit is adjusted to move the folder in synchronization with the feed dog. The distance of movement should be greater than the stitch length. This movement allows the binder to draw additional material from the roll and feed fullness under the foot. This relieves the tension created by the binding turning the 90 degree corner, and reduces the pucker and waving resulting from that tension.

SPECIFICATIONS:

Maximum speed: 4250 RPM

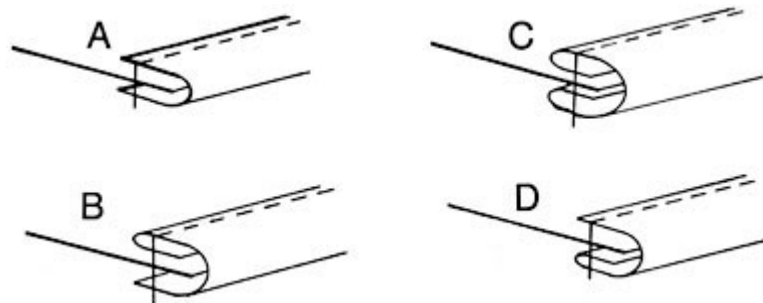

www.atlatt.com • sales@atlatt.com

PATENTS: Our equipment may be covered by one or more patents. Please go to the following web page for an up-to-date patent list: www.atlatt.com/patents.php
© 2018 Atlanta Attachment Co. 19151080719

362 Industrial Park Drive
Lawrenceville, GA 30046 USA
+1 (770) 963-7369 • FAX +1 (770) 963-7641



Atlanta Attachment Company

The Company that
Sudden Service
built

Programmable Center Knife Gauge Set

Set-in pockets

- Pocketed knit jackets
- Sweatpants
- Pockets for placket shirts
- Pockets on knit shorts
- Most industrial two needle lockstitch sewing machines

DESCRIPTION

A retrofit gauge set with movable center knife to facilitate the cutting of pocket opening in panel and pocketing material. The knife begins to cut in front of sewing stitches and moves to the rear of the needles during the sew cycle. This differential in sew length versus cut length may be changed as desired.

OPERATION

The operator places garment panel and pocketing material under presser foot, presses sewing treadle to begin sew cycle. The knife automatically shifts to the rear position after the beginning backtack is completed. The knife is reset to the front position upon completion of the finished sew cycle, thread trim and foot-lift. A machine equipped with stitch count capability will allow the operator to press the treadle once to complete the cycle automatically.

OPTIONS

Needle Gaps: 9/16" - 3/8" - 1/4"

Images may include options.

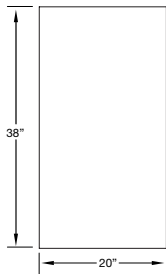
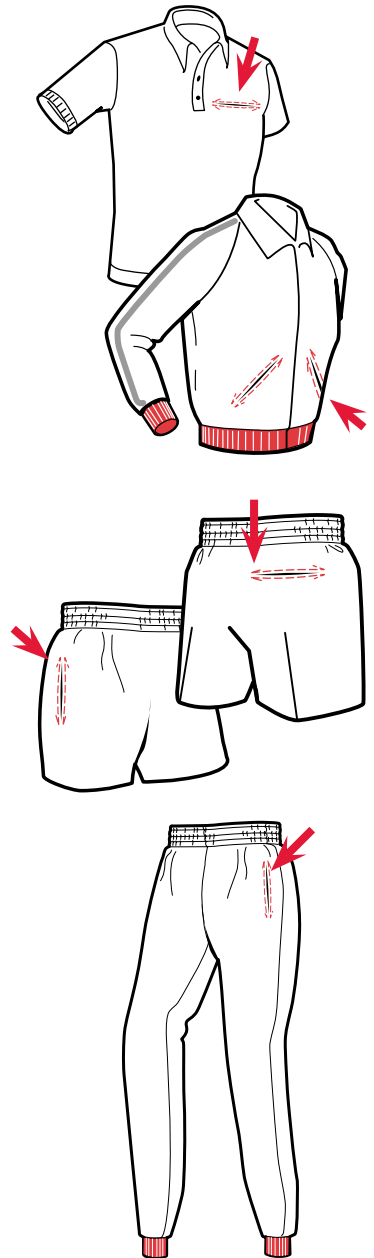

Footprint

SPECIFICATIONS	
Voltage (v/ph/hz)	220v 1ph
Current (amps)	5
Air pressure (psi)	90
Air consumption (cfm)	2
PRODUCTION	
Shorts per hour	210
Pants per hour	185

Depending on material and size of parts

www.atlatt.com • sales@atlatt.com

PATENTS: Our equipment may be covered by one or more patents. Please go to the following web page for an up-to-date patent list: www.atlatt.com/patents.php © 2018 Atlanta Attachment Co. 19151080719

362 Industrial Park Drive
Lawrenceville, GA 30046 USA
+1 (770) 963-7369 • FAX +1 (770) 963-7641



Atlanta Attachment Company

The Company that
Sudden Service
built

Images may include options.

Placket Shirt Collar Set & Tape

Fashion Knit Collar Set & Tape Attachment Gives Two-Needle Look to Finished Garment

- Modified industrial safety stitch machines

DESCRIPTION

A clean finish taping folder mounted to a safety stitch type machine behind the edge trimming knife. This folder, combined with a scissor type cutter, allows the collar seam to be taped as the collar is set. Top-stitching the tape and hanging the label in a separate operation produces a flat, uniform collar seam and gives a two-needle taping look to the finished garment.

OPERATION

An operator aligns the collar to the shirt and folds the placket over the collar. The shirt is sewn with a single needle 401 stitch to the point where the leading edge is at the tape cutter and the operator touches a knee switch to actuate the cut-apart. Sew continues and the placket is folded over the trailing end of the collar. The tape is cut as sew is completed.

OTHER MODELS

273-4

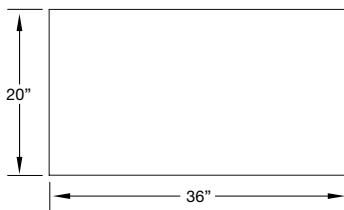
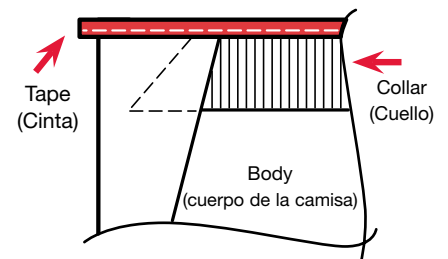

Footprint

SPECIFICATIONS	
Air pressure (psi)	60
Air consumption (cfm)	1

www.atlatt.com • sales@atlatt.com

PATENTS: Our equipment may be covered by one or more patents. Please go to the following web page for an up-to-date patent list: www.atlatt.com/patents.php © 2018 Atlanta Attachment Co. 19151080719

362 Industrial Park Drive
Lawrenceville, GA 30046 USA
+1 (770) 963-7369 • FAX +1 (770) 963-7641



Atlanta Attachment Company

The Company that
Sudden Service
built

Images may include options.

Shoulder-to-Shoulder Taping Attachment with Cutter

- Recessed blade to enhance safety
- Increased production by eliminating separate cut-apart operation
- Eliminates ergonomic problems associated with a manual cutting operation.
- Easy load increasing production
- Easy in-plant installation to existing machines.
- Operator can easily change the cutter because we use common utility knife blades
- Most off-the-arm machines

DESCRIPTION

Designed specifically for shoulder-to-shoulder taping of tee shirts on off-the-arm machines. Easy to adjust tape cutter, thumb switch, folder, tape guide, and tape reel. An optional foot switch or knee switch is also available.

OPERATION

The operator raises the presser foot into the locked position and pulls a bundle of shirts onto the arm of the machine, then lowers the foot to the sewing position and begins sewing. Each shirt is sewn and cut apart, eliminating a separate cutting operation.



Common utility knife replacement blades

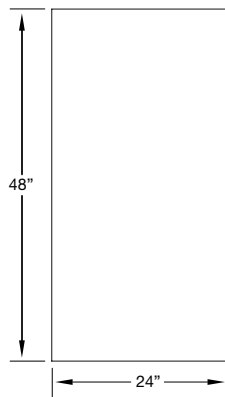

Footprint

SPECIFICATIONS	
Voltage (v/ph/hz)	220v 1ph
Current (amps)	5
Air pressure (psi)	90
Air consumption (cfm)	7
Shipping weight (lbs)	700
Shipping dimensions (w/l/h, inch)	60 x 46 x 53
PRODUCTION	
Pieces per hour	1080

Depending on material and size of parts

www.atlatt.com • sales@atlatt.com

PATENTS: Our equipment may be covered by one or more patents. Please go to the following web page for an up-to-date patent list: www.atlatt.com/patents.php
© 2018 Atlanta Attachment Co. 19151080719

362 Industrial Park Drive
Lawrenceville, GA 30046 USA
+1 (770) 963-7369 • FAX +1 (770) 963-7641



Atlanta Attachment Company

The Company that
Sudden Service
built

Images may include options.

Shirt Collar Set & Tape

Collars • Cuffs • Bottom Bands

- Private label prior to shipping
- Electronic metering provides:
 - Uniform sizing
 - Push button size changes
 - Consistent repeatability
- Self-contained unit applicable to most industrial overlock machines

DESCRIPTION

The shirt collar is set and tape applied with one shoulder closed in one operation. This provides a shoulder-seam-to-shoulder-seam display tape and allows tape top-stitch and label as final operation.

OPERATION

Consists of a variable speed rib knit collar tape feeder and a movable taping folder. The collar is applied to a shirt with one shoulder open. The taping is engaged at start of sew and disengaged as the shoulder seam approaches the presser foot.

OPTIONS

ATC1 close couple pneumatic
Scissor knife (as shown in photos)

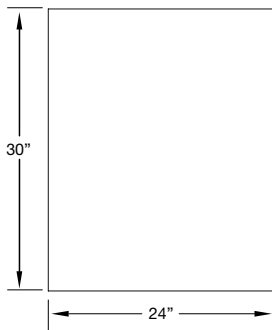
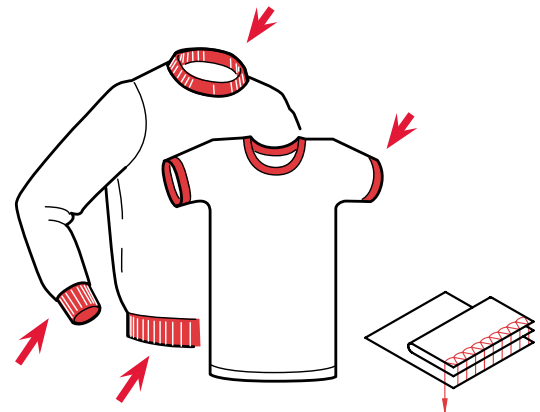
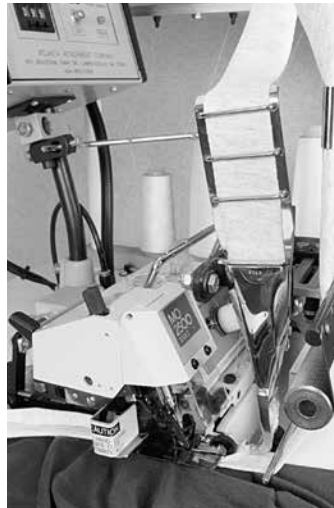

Footprint

SPECIFICATIONS	
Voltage (v/ph/hz)	220v 1ph
Current (amps)	5
Air pressure (psi)	90
Air consumption (cfm)	2
PRODUCTION	
Pieces per hour	210

Depending on material and size of parts

www.atlatt.com • sales@atlatt.com

PATENTS: Our equipment may be covered by one or more patents. Please go to the following web page for an up-to-date patent list: www.atlatt.com/patents.php
© 2018 Atlanta Attachment Co. 19151080719

362 Industrial Park Drive
Lawrenceville, GA 30046 USA
+1 (770) 963-7369 • FAX +1 (770) 963-7641



Atlanta Attachment Company

The Company that
Sudden Service
built

Images may include options.

Automatic Backlatch System

The most simple, trouble-free backlatch in the world!

- Instantaneous tensionless backlatch
- No knots or skipped stitches, guaranteed!
- Minimal operator training
- Electronic motor not required
- Reduces needle & parts breakage
- Eliminates repairs
- Most industrial over-locks
- Motor: Clutch or electronic

DESCRIPTION

A pneumatically controlled and operated system consisting of patented hollow chaining tongue throat plate, chain cutting knife, and pneumatic foot-lift control package.

OPERATION

The operator folds and places the part to be sewn at or under the presser foot in normal fashion. As the sew treadle is depressed, the automatically controlled vacuum generator draws the chain from the previous piece toward the operator into the hollow chaining tongue as the chain is sewn into the seam. Upon completion of sew, the operator draws the piece to the rear of the unit and cuts the chain by depressing a knee or heel switch. The amount of chain which remains is automatically drawn into the chaining tongue to form the backlatch for the next piece. Electronic motor is not required.

OPTIONS

Available with photo cell control in conjunction with electronic motor.
Feed dogs

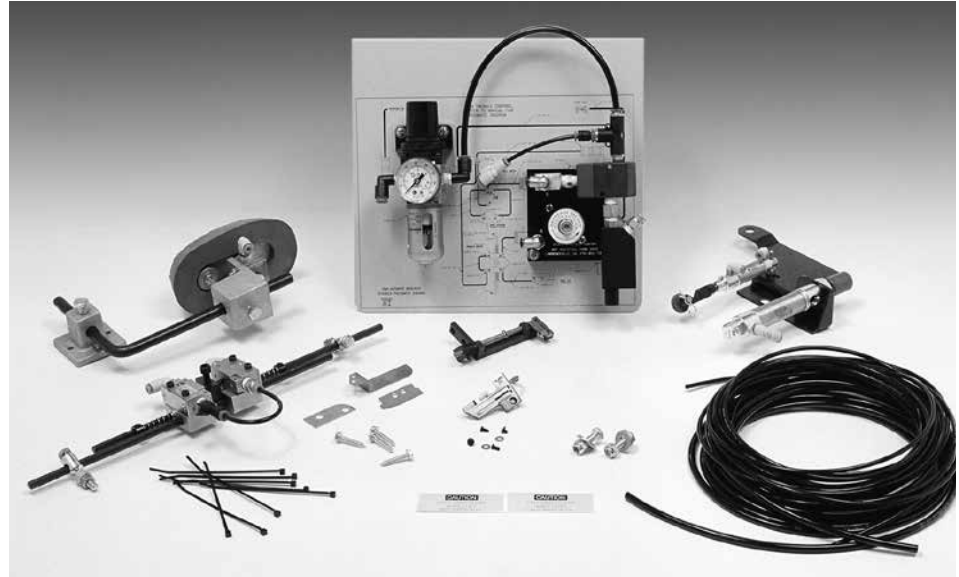

Patented
Works with clutch or electronic motor

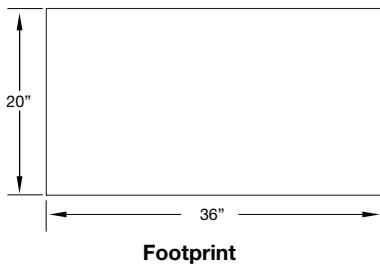

SPECIFICATIONS	
Voltage (v/ph/hz)	220v 3ph
Current (amps)	5
Air pressure (psi)	90
Air consumption (cfm)	7

www.atlatt.com • sales@atlatt.com



Images may include options.

Electronic Metering

Upper or Lower Metering System

- Easy digital setting
- Non-slip metering head
- Available for all machines
- Optional dual tension controls
- Free-stand unit to fit all sewing heads and applications

DESCRIPTION

An electronically controlled metering system with stepping motor drive. This unit gives accurate repeatable size control. The unit is available with single or dual controls for intermittent metering.

OPERATION

The electronic control utilizes a synchronizer to activate the stepping motor driven metering head in unison with sewing speed. Tension settings are changed by the push of a button.

OPTIONS

Dual tension control for intermittent metering or multi-function metering settings.

AP28M Miniature electronic metering device (Lower Mount)

ATC1 Close couple pneumatic scissor knife



Lower metering



Upper metering

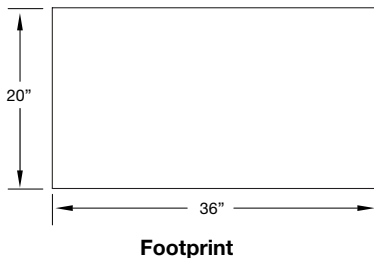
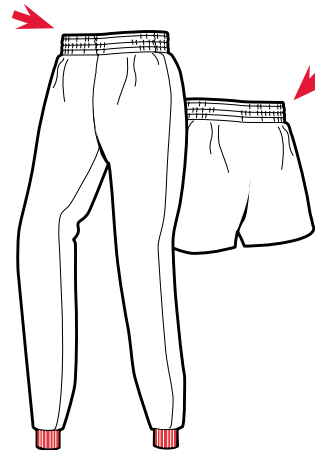

SPECIFICATIONS

Voltage (v/ph/hz)	220v 1ph
Current (amps)	3

www.atlatt.com • sales@atlatt.com

PATENTS: Our equipment may be covered by one or more patents. Please go to the following web page for an up-to-date patent list: www.atlatt.com/patents.php
© 2018 Atlanta Attachment Co. 19151080719

362 Industrial Park Drive
Lawrenceville, GA 30046 USA
+1 (770) 963-7369 • FAX +1 (770) 963-7641



Atlanta Attachment Company

The Company that
Sudden Service
built

Images may include options.

Programmable Cutter Cap Operation

Electronically controlled, air operated device, designed to cut apart and/or trim continuous sewn material such as binding, belt loops, waistbands, etc., up to 1 1/2" wide. This unit consists of a fast action toggle link knife, a 10-function control box, two retro-reflective eyes, two three-digit counters and a pneumatic power pack.

- Eliminate the costly cut-apart operation
- Available for any make or model flatbed or cylinder arm machine
- Ten function control box for multiple operations
- Installs in-plant in approximately two hours
- Switch to a different machine as needed
- Does not require special electronic motor
- Binding saving feature, stops the sewing machine automatically after the trailing edge cut
- All industrial flat bed or cylinder bed lock & chain-stitch machines. Unit may be transferred from one machine to another after initial installation procedure.

OPTIONS

Binding may be cut flush with the garment on both ends or a specified length of binding can be left to fold back and tack, or form tie strings, unit may be used as a loop cutter, label insert control and end trim, or any of six other operations.



OPERATION

The operator positions the rotary selector switch to choose any one of the following 10 functions:

1. Cut leading edge and trailing edge with auto-stop binding saver.
2. Cut leading edge and trailing edge without auto-stop binding saver.
3. Cut leading edge only.
4. Cut trailing edge only.
5. Cut trailing edge only with auto-stop binding saver.
6. Butt garments and cut apart (using trailing edge counter).
7. Cut long tie strings (apron, shoulder ties, etc.).
8. Continuous cut belt loops, belts, ties (using trailing edge counter).
9. Same as #8 above except also uses leading edge counter to stop machine after cutting preset number of pieces.
10. Uses leading edge counter to stop for label insertions, cuts trailing edge with auto-start binding saver.

Depressing the manual cut button resets the knife after selection. All cuts whether flush or preset length are accurate within + or - one stitch. The binding saver will automatically stop the sewing machine to reduce material waste.

Images may include options.

Programmable Fast Action Knife

- Self-contained system does not require electronic motor
- Binding
- Taping
- Belt Loops
- Apron Strings
- Cap Sweat Bands
- Collarettes
- Most industrial sewing machines

DESCRIPTION

An electronically controlled pneumatic scissor-type knife designed to cut apart and/or trim continuous sewn material such as binding, belt loops, waistbands, etc., up to 1 1/2" wide. This unit consists of a fast action toggle link knife, a keypad programmable control box with LCD readout, edge sensing and stitch count capability, with automatic binding saver to prevent material waste.

OPERATION

The operator selects any programmed function by pressing numbers on the keypad (the stitch count and cut function are clearly visible on an LCD readout). Each sequence may be inspected or altered by following the program sequence; for example, program one, cut leading and trailing edge with automatic binding saver: material is inserted into a binder and depressing the sew treadle initiates sewing. A reflective eye senses the leading edge and the binding is cut after a preset number of stitches without stopping. Sewing continues until the trailing edge is sensed and after counting the preset number of stitches the binding is cut and sewing is automatically stopped to prevent material waste. Any number of cut and trim values may be entered and retained for different styles or sizes.

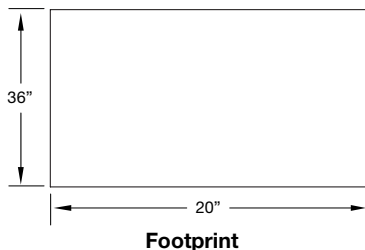
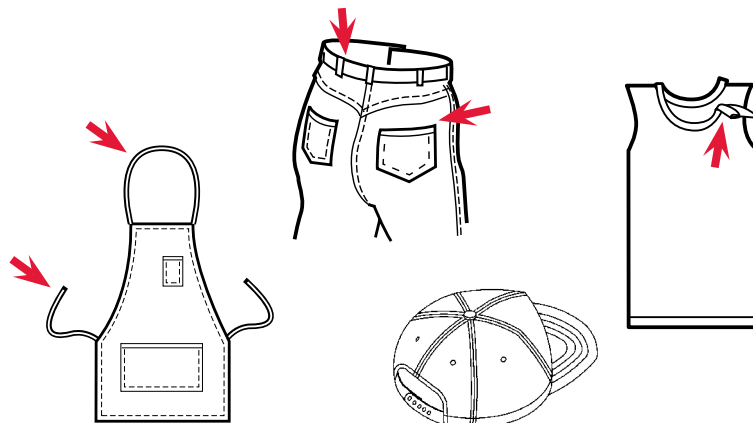
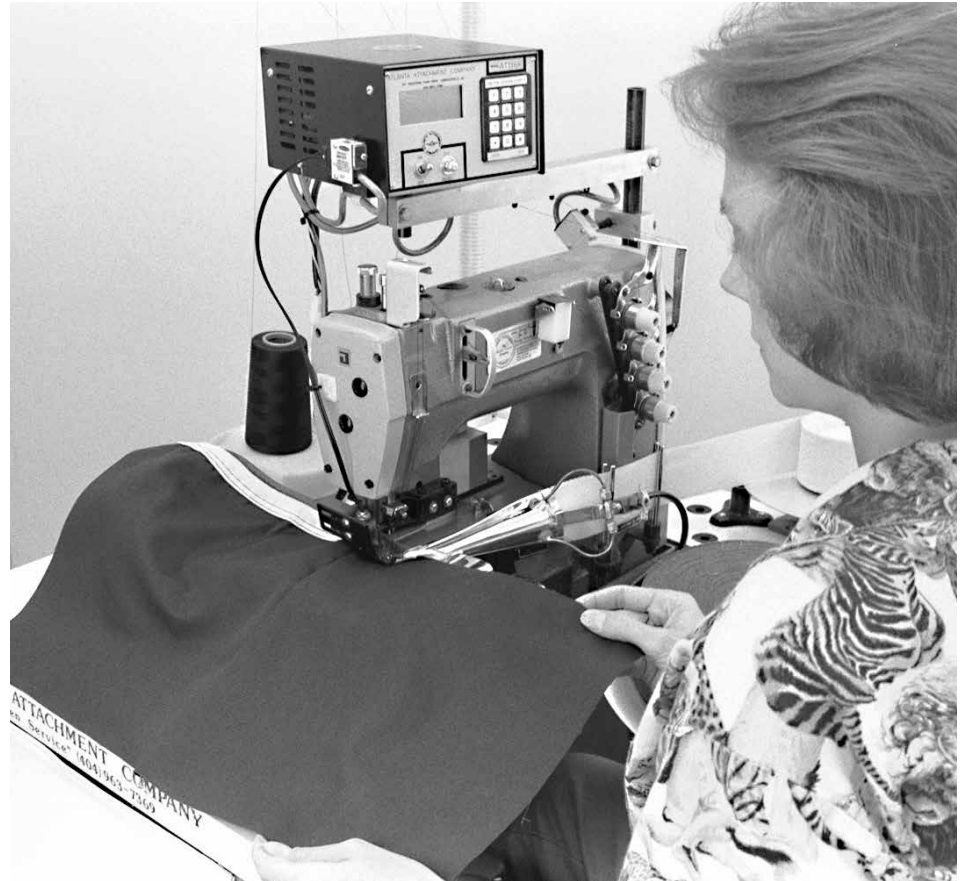

SPECIFICATIONS

Voltage (v/ph/hz)	220v 1ph
Current (amps)	5
Air pressure (psi)	60
Air consumption (cfm)	4

www.atlatt.com • sales@atlatt.com

PATENTS: Our equipment may be covered by one or more patents. Please go to the following web page for an up-to-date patent list: www.atlatt.com/patents.php
© 2018 Atlanta Attachment Co. 19151080719

362 Industrial Park Drive
Lawrenceville, GA 30046 USA
+1 (770) 963-7369 • FAX +1 (770) 963-7641



Atlanta Attachment Company

The Company that
Sudden Service
built

Images may include options.

Programmable Jeans Front Pocket Taping System

The single upturn hemmer hems the curved front pocket while attaching the pocket lining and tape. An electronically controlled fast action knife cuts the tape flush without stopping.

- Self-contained system does not require electronic motor
- Hems & tapes curved jeans front pocket without twist or roll-out
- Separate controls for hemming left and right pockets
- Most industrial two-needle lock-stitch sewing machines.

OPERATION

The operator places the pocket and the lining in the folder. Sewing begins and the fast action knife cuts the tape flush on the leading edge. At the completion of sew, the trailing edge tape is also trimmed flush.

PRODUCTION

Approximately 207 pieces per hour depending on material and size of parts.-

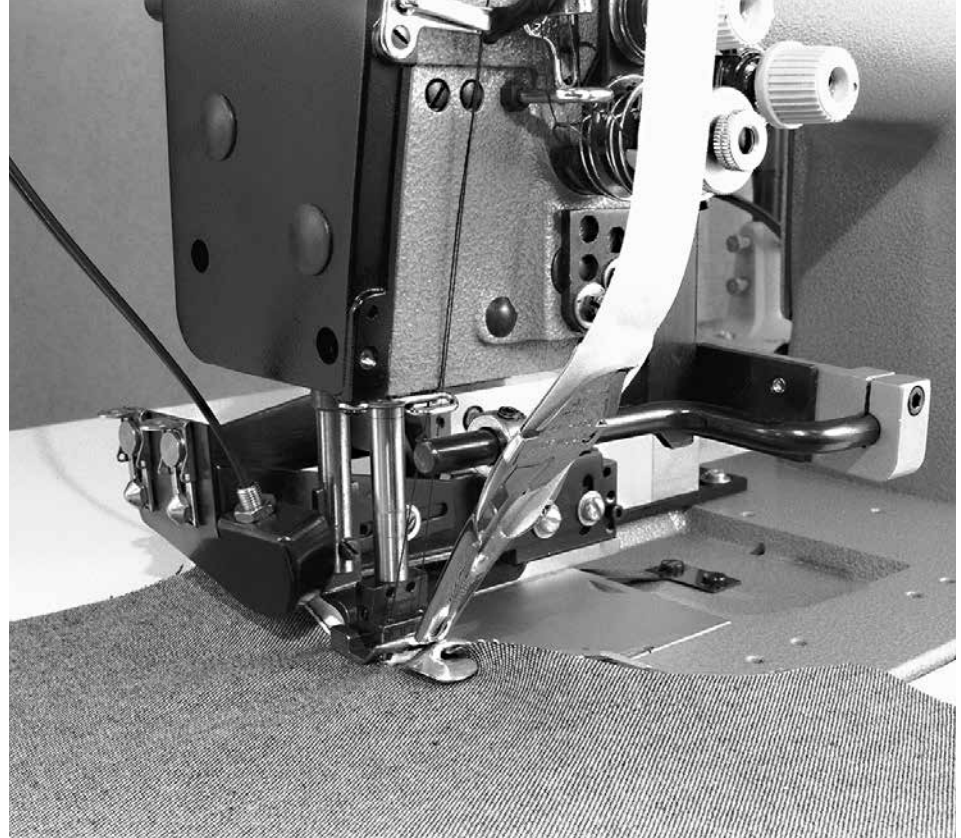

SPECIFICATIONS

Voltage (v/ph/hz)	220v 1ph
Current (amps)	60
Air pressure (psi)	90
Air consumption (cfm)	4

www.atlatt.com • sales@atlatt.com

PATENTS: Our equipment may be covered by one or more patents. Please go to the following web page for an up-to-date patent list: www.atlatt.com/patents.php
© 2018 Atlanta Attachment Co. 19151080719

362 Industrial Park Drive
Lawrenceville, GA 30046 USA
+1 (770) 963-7369 • FAX +1 (770) 963-7641



Atlanta Attachment Company

The Company that
Sudden Service
built

Images may include options.

Center Cut-Apart for Stripes

Center Cut-Apart Knife for Separating Pieces where Stripes or Bands are Sewn in the Middle of the Fabric.

- Pneumatic operation with safety device
- Controls may be pneumatic, electric or automatic
- Long lasting, low cost round blades
- Effective cutting width to suit your operation
- Custom designed to fit most industrial machines

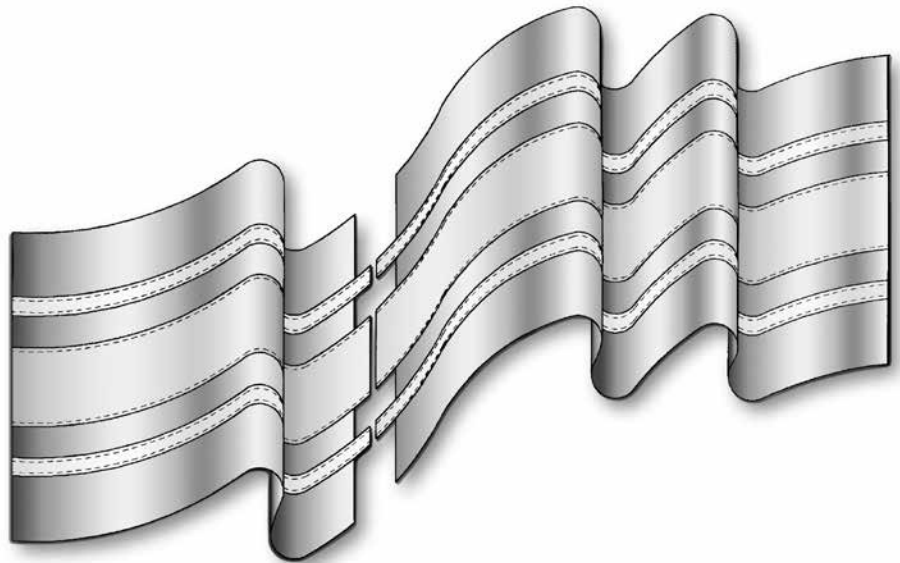
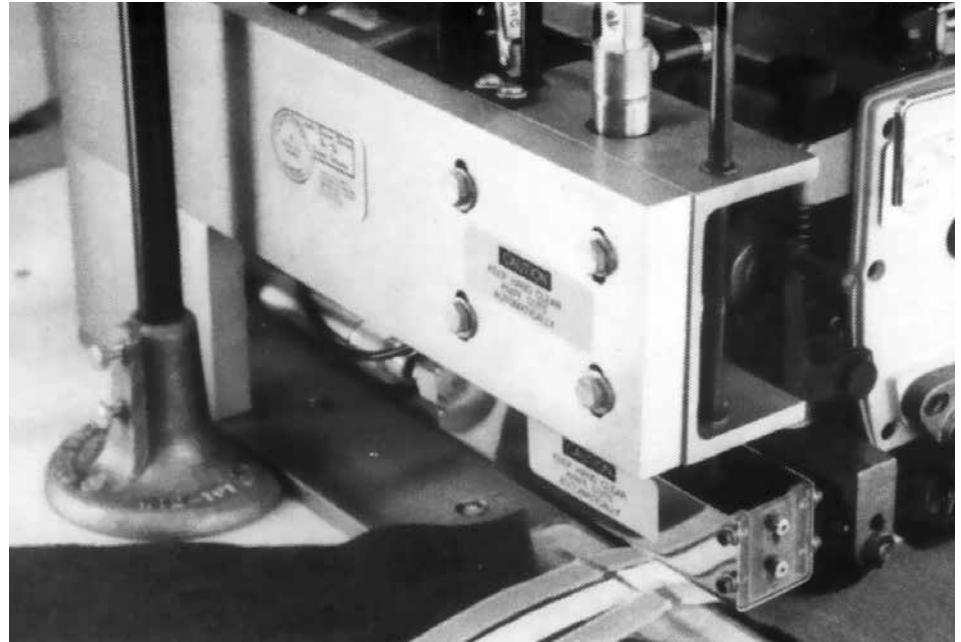

SPECIFICATIONS

Air pressure (psi)	60
Air consumption (cfm)	2

www.atlatt.com • sales@atlatt.com

PATENTS: Our equipment may be covered by one or more patents. Please go to the following web page for an up-to-date patent list: www.atlatt.com/patents.php
© 2018 Atlanta Attachment Co. 19151080719

362 Industrial Park Drive
Lawrenceville, GA 30046 USA
+1 (770) 963-7369 • FAX +1 (770) 963-7641



Atlanta Attachment Company

The Company that
Sudden Service
built

Images may include options.

Walker Tape Feeder

The Walker Tape Feeder is a dispensing device for all types of zipper chain, lace, elastic or other trims.

The tape feeder unit keeps slack in trim and delivers it to the sewing machine in a relaxed condition. This eliminates inconsistent measurements for garments with elastic and increases production because there is no wasted trim or time. Can be mounted above or below the tabletop.

- All industrial sewing machines

OPTIONS

WW2220 - 220v

WW2210 - 110v

Aluminum, steel, rubber, or zipper-grooved rollers

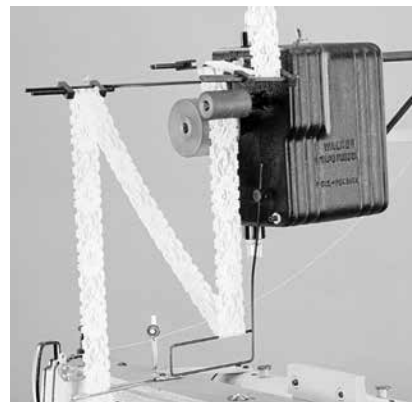
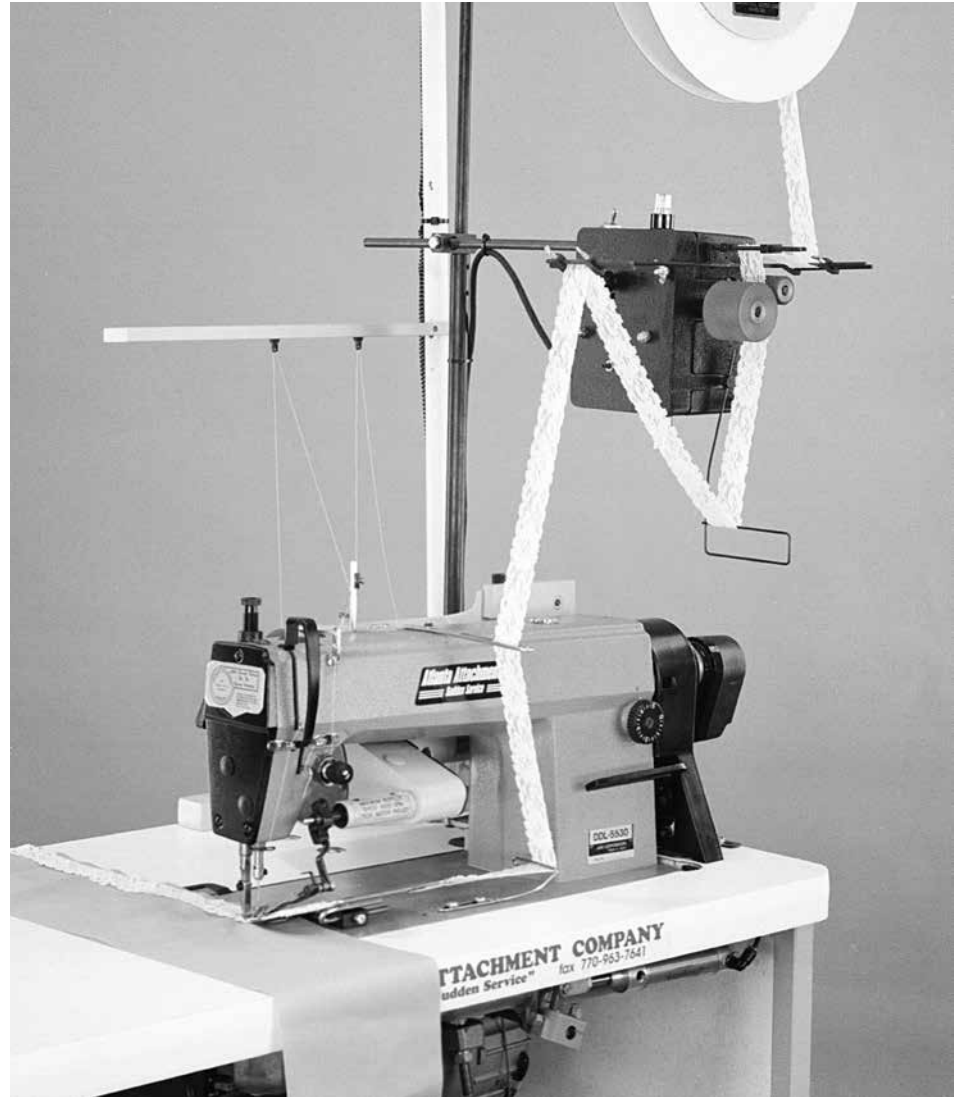

SPECIFICATIONS

Voltage (v/ph/hz)	110 or 220v 1ph
Current (amps)	2

www.atlatt.com • sales@atlatt.com

PATENTS: Our equipment may be covered by one or more patents. Please go to the following web page for an up-to-date patent list: www.atlatt.com/patents.php
© 2018 Atlanta Attachment Co. 19151080719

362 Industrial Park Drive
Lawrenceville, GA 30046 USA
+1 (770) 963-7369 • FAX +1 (770) 963-7641



Atlanta Attachment Company

The Company that
Sudden Service
built

FOLDERS and OTHER ATTACHMENTS

- TEE SHIRTS
- PLACKET SHIRT
- SWEAT SHIRT
- HOODED SWEAT SHIRT
- SWEAT PANTS & SHORTS
- OTHER
- ATTACHMENTS & OTHER EQUIP
- WORKSTATION

Images may include options.

Sewing Machine Folders & Attachments

We have a dedicated division just for making folders and attachments. This is what our company was founded on in 1969 and our team of skilled craftsmen create these folders by hand to meet the specifications of your products.

- Standard binders and folders in stock
- Custom made binders and folders made in 5-7 working days from customer supplied sample



201
Right Angle Binder



423
Elbow Banding Folder



420C
Sleeve Facing Folder



301
Clean Finish Swing Hemmer



Zipper Attachments



Hemming Attachments



192
Collarette Binding Folder



Welting Attachments

www.atlatt.com • sales@atlatt.com

PATENTS: Our equipment may be covered by one or more patents. Please go to the following web page for an up-to-date patent list: www.atlatt.com/patents.php
© 2018 Atlanta Attachment Co. 19151080719

362 Industrial Park Drive
Lawrenceville, GA 30046 USA
+1 (770) 963-7369 • FAX +1 (770) 963-7641



Atlanta Attachment Company

The Company that
Sudden Service
built

Images may include options.

**Presser Foot
Feed Dog
Throat Plate
Needle Holders
Looper Holders
Needle Guards
Knives**

Atlanta Attachment is a complete source for your gauge set needs. Our sets are produced to exact specifications for your individual needs. The most popular gauge sets are in stock. We can produce replacements or special needs within 10 working days. Call our sales staff to see what we can do to meet your needs.

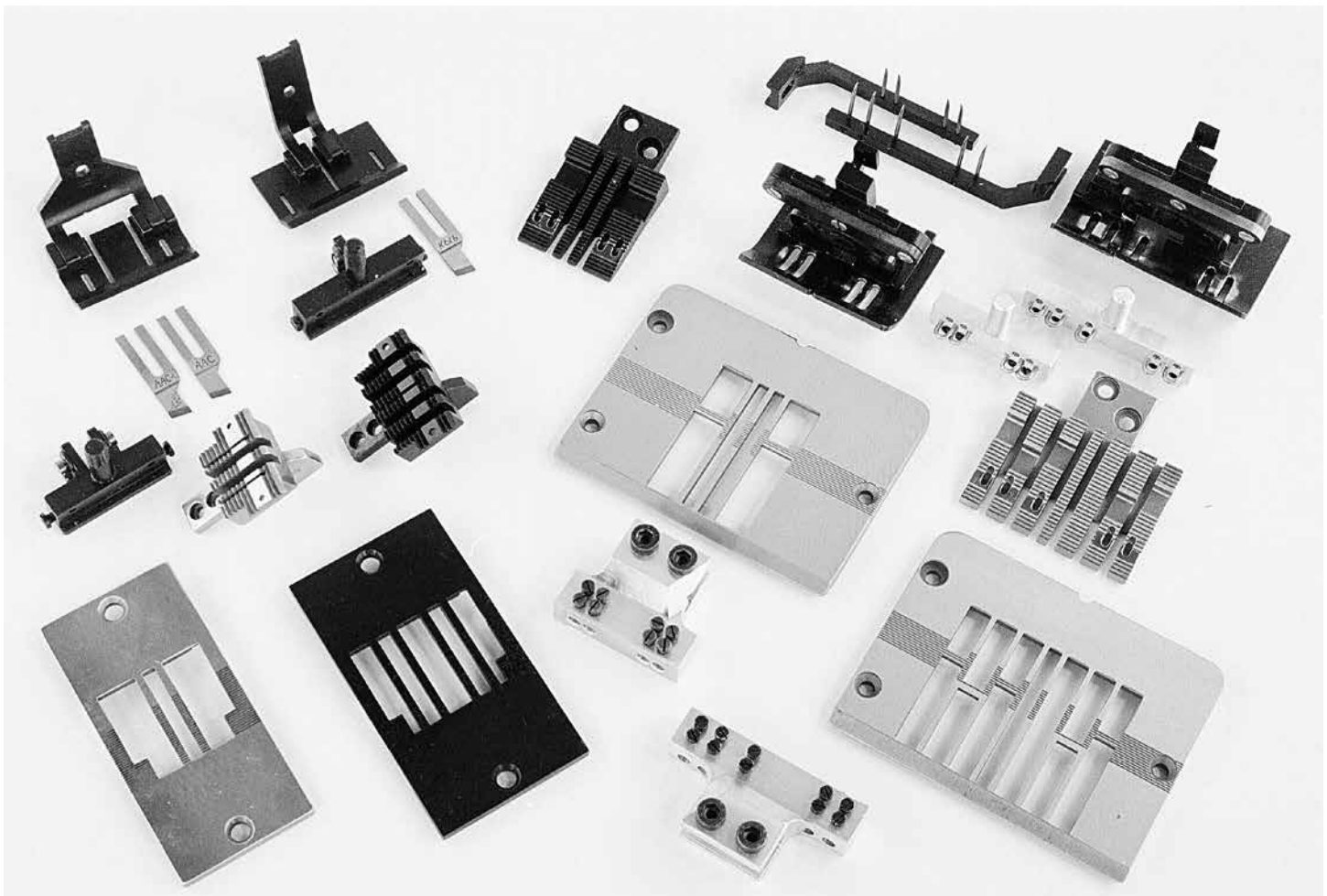

www.atlatt.com • sales@atlatt.com

PATENTS: Our equipment may be covered by one or more patents. Please go to the following web page for an up-to-date patent list: www.atlatt.com/patents.php
© 2018 Atlanta Attachment Co. 19151080719

362 Industrial Park Drive
Lawrenceville, GA 30046 USA
+1 (770) 963-7369 • FAX +1 (770) 963-7641



Atlanta Attachment Company
The Company that
Sudden Service
built

Images may include options.

Sewing Machine Pedals

- Sit-down pedals for clutch or electronic motors
- Stand-up pedals
- Various configurations from 1 to 4 pedals to control all or individual functions
- Custom pedals manufactured to customer specification.

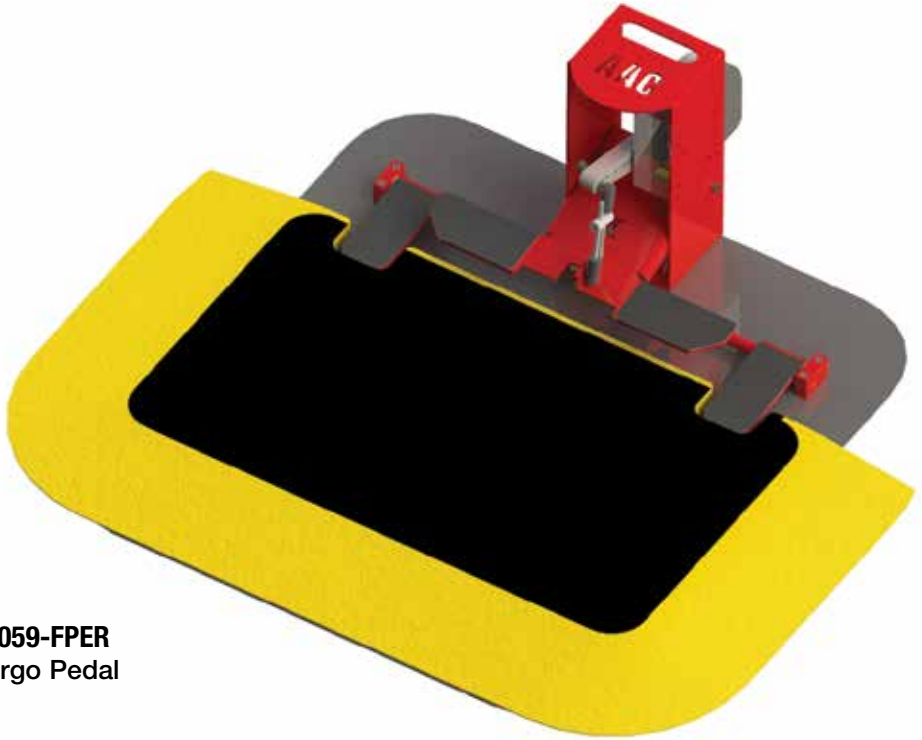

4059-FPER
Ergo Pedal



4059-FP-3J



4059-FP301B



4059-FP301G



4059-FP301A

www.atlatt.com • sales@atlatt.com

PATENTS: Our equipment may be covered by one or more patents. Please go to the following web page for an up-to-date patent list: www.atlatt.com/patents.php
© 2018 Atlanta Attachment Co. 19151080719

362 Industrial Park Drive
Lawrenceville, GA 30046 USA
+1 (770) 963-7369 • FAX +1 (770) 963-7641



Atlanta Attachment Company

The Company that
Sudden Service
built

Images may include options.

Atlanta Attachment has been building custom-made pullers for over 25 years

- Synchronized close coupled pullers
- Continuous feed type pullers
- Custom design for each operation
- Top or bottom drive
- Top & bottom drive
- Special rollers: steel, rubber, urethane, fiber, knurled, fluted or plain
- Upper & lower compensating rollers
- Available for all machine classes

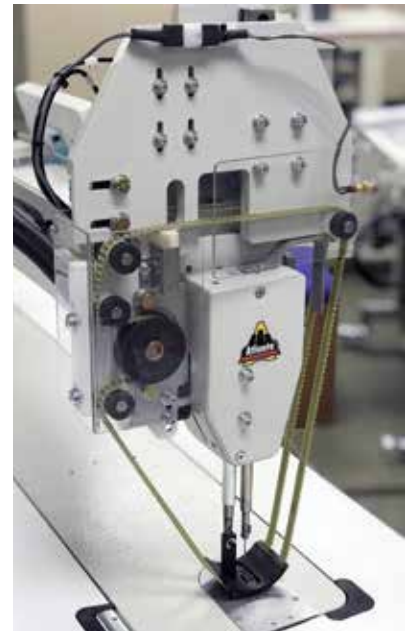
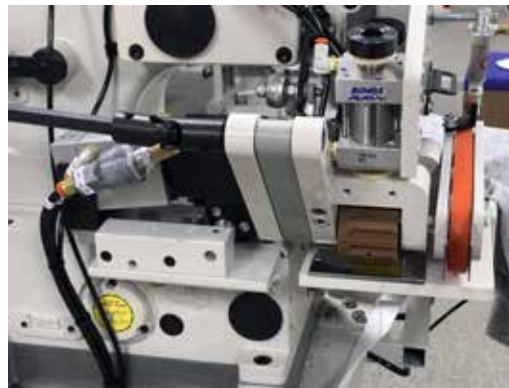

www.atlatt.com • sales@atlatt.com

PATENTS: Our equipment may be covered by one or more patents. Please go to the following web page for an up-to-date patent list: www.atlatt.com/patents.php
© 2018 Atlanta Attachment Co. 19151080719

362 Industrial Park Drive
Lawrenceville, GA 30046 USA
+1 (770) 963-7369 • FAX +1 (770) 963-7641



Atlanta Attachment Company

The Company that
Sudden Service
built

Images may include options.

Sewing Machine Stands

- Sit-down operation
- Stand-up operation (reinforced)
- Ergo stands with manual or electric height adjustment
- All stands available with or without casters
- Tilttable with hand crank



Motorized Ergo Stand with Adjustable Height



T-Leg



H-Leg



K-Leg

Sewing Machine Tables

- All shapes and sizes available from 20" x 48" rectangular, to 48" x 60" L-shape
- Custom tables available by special order
- Custom engineered air floatation tables



Smooth



Textured

www.atlatt.com • sales@atlatt.com

PATENTS: Our equipment may be covered by one or more patents. Please go to the following web page for an up-to-date patent list: www.atlatt.com/patents.php
© 2018 Atlanta Attachment Co. 19151080719

362 Industrial Park Drive
Lawrenceville, GA 30046 USA
+1 (770) 963-7369 • FAX +1 (770) 963-7641



Atlanta Attachment Company

The Company that
Sudden Service
built

Images may include options.

Serial Bus Control System

8.4" Color Screen

Automated Sewing Equipment with the Patented Serial Bus Control System

Unconditional Warranty 3 Years Unconditional...Period!

Our new Serial Bus Control System is a quantum change for our automated sewing equipment and the sewn products industry. Our Serial Bus System, based on only four wires, is self-diagnostic and offers helpful solutions to solve the problem.

An operator using a touch screen control panel manages this rugged, uncomplicated system. Designed to international standards, this multi-lingual, easy to operate interface will allow parameters to be saved, allow technician access with password protection and offers a built-in production performance monitor which can be networked to a central computer.

A warranty is a fulfillment promise to be honored with pride. At Atlanta Attachment Company we are proud to honor our 3-Year warranty which is unsurpassed in the industry. This warranty covers all electrical components of the state-of-the-art Serial Bus Control System used on our Automated Sewing Workstations.

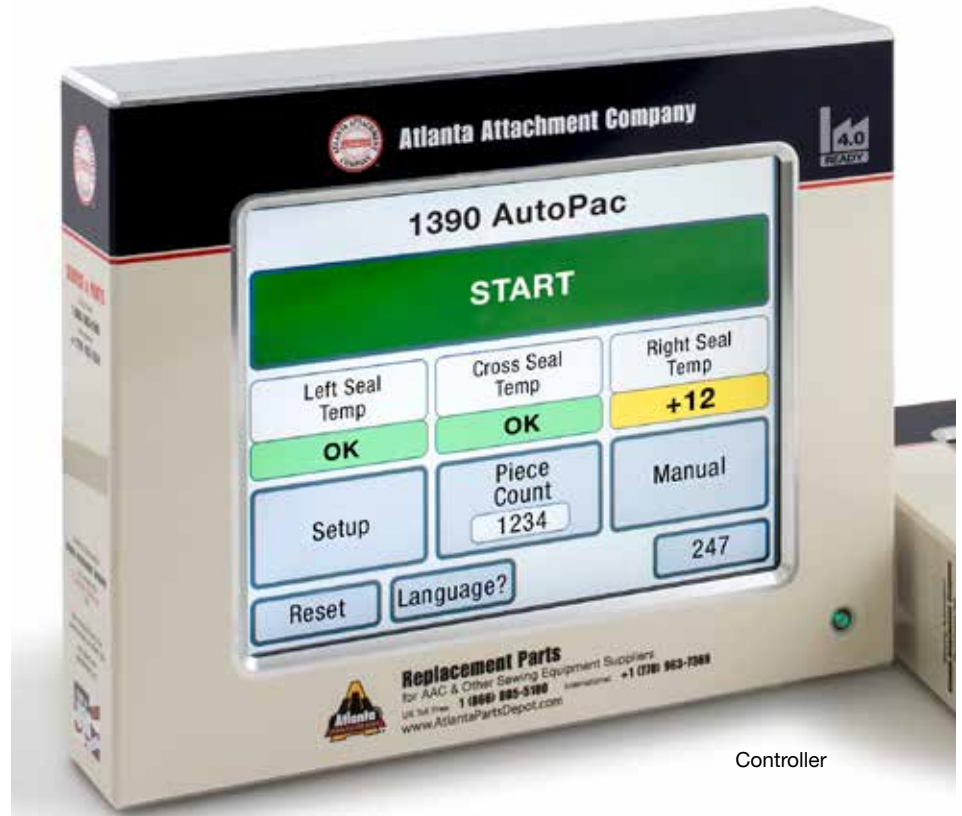

Controller



Modules & Connectors



Ports included:
Ethernet
USB (2)
USB Download

www.atlatt.com • sales@atlatt.com



Images may include options.

HSView

Live Inventory Management

RFID Technology

Making Inventory Management Easier

- Software and hardware solutions to manage all areas of inventory
- Application modules:
 - Raw Materials
 - WIP
 - Finish Goods
 - Shipping
 - Printing
- Modules can be implemented in stages
- RFID readers count and identify products or components automatically when passing through readers or when read by hand scanners
- No need to count and manually input individual items
- Increased accuracy of inventory on a daily, weekly or monthly basis
- Reduction in time, production loss, and labor cost from taking physical inventories
- Purchase pre-made tags or print RFID tags
- Placement of RFID tag can be most anywhere in the product
- Exception reporting

Additional items available

- Integration assistance into current operational software
- Customized reporting



Placement of RFID tag can be most anywhere in the product

www.atlatt.com • sales@atlatt.com

PATENTS: Our equipment may be covered by one or more patents. Please go to the following web page for an up-to-date patent list: www.atlatt.com/patents.php
© 2018 Atlanta Attachment Co. 19151080719

362 Industrial Park Drive
Lawrenceville, GA 30046 USA
+1 (770) 963-7369 • FAX +1 (770) 963-7641



Atlanta Attachment Company

The Company that
Sudden Service
built

SYSTEMS & Software Shop Floor Control

Images may include options.



BYTETIME™ Real-Time Shop Floor Control

- Piecework or Hourly Payroll
- Production Tracking
- Quality Control
- Machine Parts Tracking
- Shipping and Receiving

Industry experience since 1976 and over 100,000 installed users in 17 countries,

Byte is the most advanced and mature Shop Floor Control System to the sewn products industry. Based on off the shelf Wi-Fi technology utilizing Android tablets.

- **In-house Development**
- **Made in USA**
- **Flexible & Customizable**
- **Batch + Real Time, Hybrid or Both**

COST ADVANTAGES

Cut excess labor cost
Higher productivity
Lower wip inventory
Reduce payroll errors
No bundle ticket coupons
Reduce payroll processing

OPERATIONAL ADVANTAGES

Reduce labor
Faster throughput/less WIP
Balanced lines
Better employee morale
Lower turnover
Improved quality
More accurate payroll
Clock in/out at workstation
Quicker response time

TECHNICAL ADVANTAGES

Sql database - for flexibility and performance.
Tablets - Android
Wireless - no wired installation required.
Connectivity - direct integration with Byte's payroll and ERP modules.
Reliable - stores transactions when network down.

OPERATORS / EMPLOYEES

Time - replaces punch clock for in/out and breaks.
Pacing - helps operator achieve target
Always on - camera, for easy qr/bar code scanning.
Simple - intuitive user interface.

SUPERVISOR APP

Operators - track operator efficiency
Off-Standard - direct or remote off standard approval
Repairs - track bundle or unit repairs
Production - track WIP through assigned sections
Support - get instant notification of operator calls

www.atlatt.com • sales@atlatt.com

PATENTS: Our equipment may be covered by one or more patents.
Please go to the following web page for an up-to-date patent list: www.atlatt.com/patents.php
© 2018 Atlanta Attachment Co. 19151080719

362 Industrial Park Drive
Lawrenceville, GA 30046 USA
+1 (770) 963-7369 • FAX +1 (770) 963-7641



Atlanta Attachment Company

The Company that
Sudden Service®
built

Images may include options.

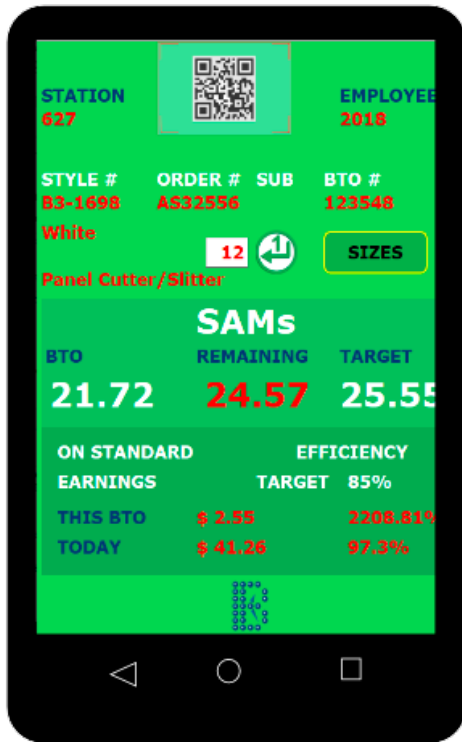

Production App

A uniquely redefined Shop Floor Control and piecework payroll system based on inexpensive, off-the-shelf, Wi-Fi enabled Android Tablets is simple to learn, deploy and operate. Byte's software suite includes a bundle tracking system which has been reinvented from the ground up. It was co-developed with sewn products manufacturing customers and is now a shop floor system that satisfies the software requirements of large and small manufacturing companies AT AN AFFORDABLE COST.

From WIP tracking through Piecework Payroll and all of the HR issues associated with a sewn products manufacturing company are available with software modules from Byte's ERP Software Suite.

Simple to deploy, the system operates over standard Wi-Fi protocol and requires no network wiring or unusual proprietary hardware. Deploy and train in days rather than weeks. The Android Tablets have an app that keeps the camera on so that passing a Bundle tag with a QR code in front of it, records the bundle number. The tablet itself has an ID setup in Byte to Identify which operation is being performed at that station and the operator logs into the tablet in order to credit the work to the right operators. Each of the transactions is time stamped to allow for efficiency and pay calculations.

Using this advanced technology, operators are able to quickly log in or perform routine functions simply by scanning their employee badge. The ability to automate common tasks for both operators and supervisors adds efficiency to the manufacturing process.

There are four primary APPS available for BYTETIME™

Operator – As described above and much more.

Supervisor – Receives Off-Standard call from operator and allows approval from the floor or desk. Tracks off standard, efficiencies, WIP and repairs.

Quality – Full QC and statistical analysis for in-line, final, block and product inspections with normal and accelerated AQL tables.

Equipment – Mechanics monitor operator or supervisor calls for maintenance. Machines by ID are analyzed and scheduled for repairs.

All administrative chores are performed seamlessly between the tablets and the database that insures instant validation and synchronization between the tablets and the database.

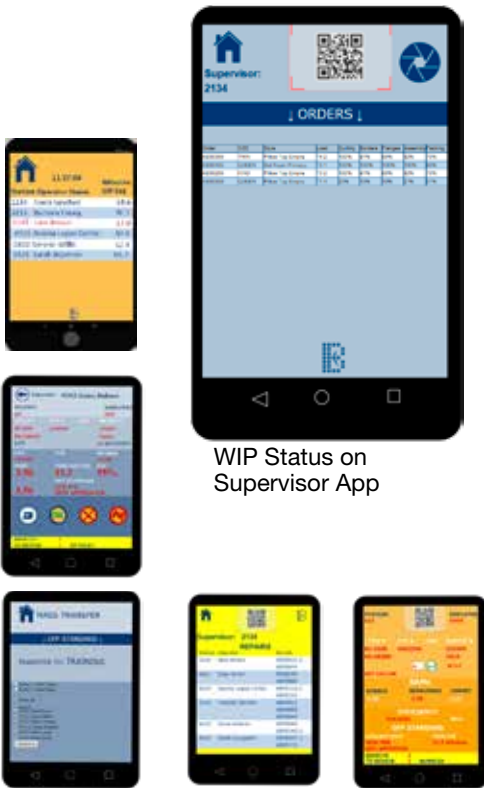

WIP Status on Supervisor App

www.atlatt.com • sales@atlatt.com

PATENTS: Our equipment may be covered by one or more patents. Please go to the following web page for an up-to-date patent list: www.atlatt.com/patents.php © 2018 Atlanta Attachment Co. 19151080719

362 Industrial Park Drive
Lawrenceville, GA 30046 USA
+1 (770) 963-7369 • FAX +1 (770) 963-7641



Atlanta Attachment Company

The Company that
Sudden Service
built

EXPENDABLE REPLACEMENT PARTS

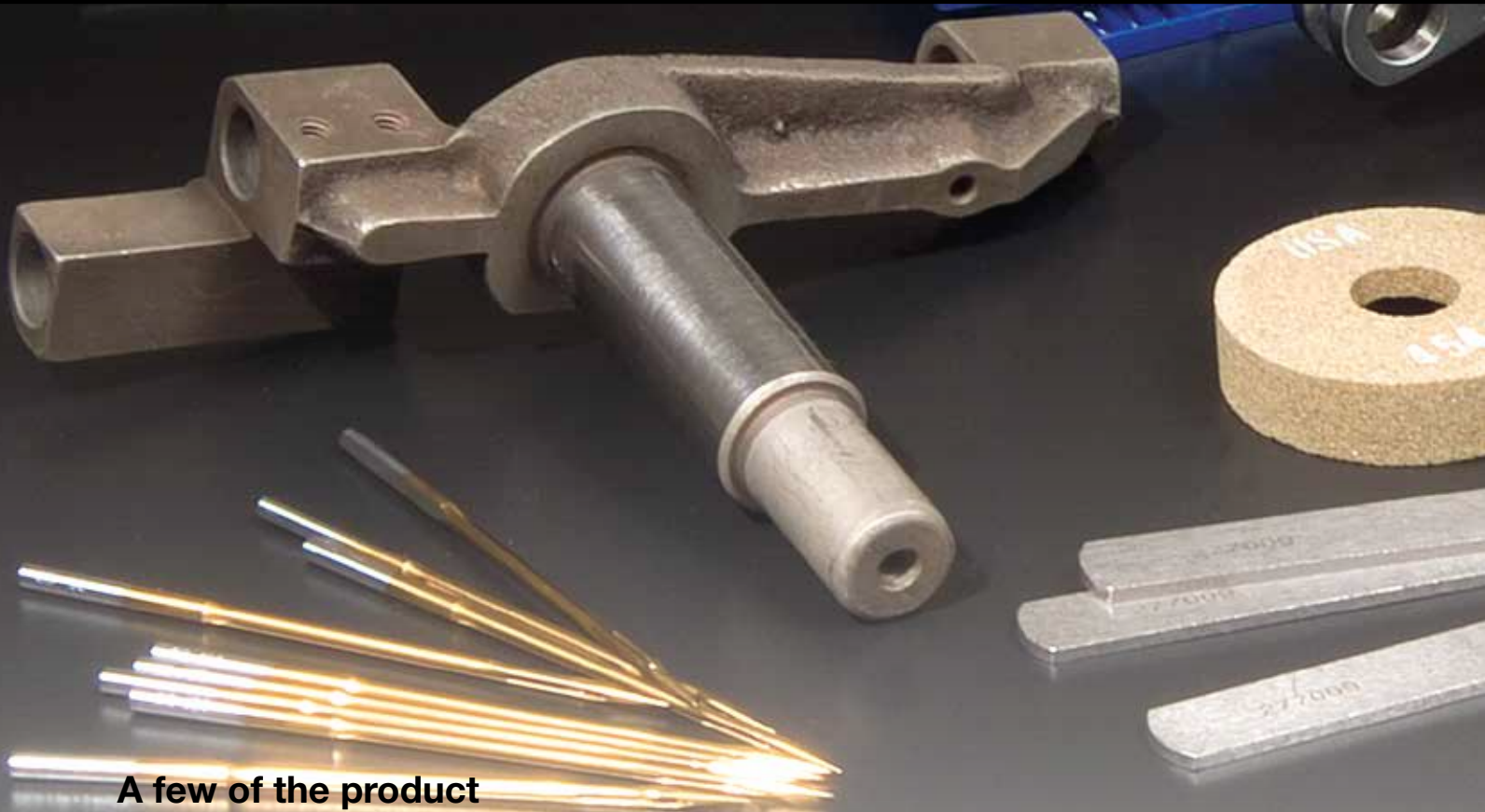

A few of the product lines carried:

- Atlanta Attachment
- Brother
- Cash
- Consew
- Durkopp Adler
- Efka
- Galkin
- Gribetz
- Groz-Beckert
- ITW Dynatec
- Juki
- Meistergram
- Mitsubishi
- Organ
- Pegasus
- Pfaff
- Porter
- Ricoma
- Schmetz
- Singer
- SunStar
- Tajima
- Typical
- Union Special
- United
- Vetron
- Wilcox & Gibbs
- Yamato

Type of Parts

- Cutting Blades
- Feed Dogs
- Knives
- Loopers
- Needle Bars
- Presser Feet
- Rotary Hooks
- Spreaders
- Shears & Scissors
- Synchronizers
- Needles

Is Your Sewing Equipment In Need of a Replacement Part?

We stock replacement parts for most industrial sewing machines for the sewn products industry

www.atlatt.com • sales@atlatt.com



72 Hours or FREE!*

As the leading supplier of automated sewing workstations, Atlanta Attachment Company pledges unequalled service and support to our valued customers. We pledge to maintain inventories of the recommended spare parts for our automated workstations* and to ship those replacement parts within 72 hours. If the expendable replacement parts are not shipped within 72 hours they will be

Free of Charge!

* Contact sales for the recommended spare parts list and the model workstations covered.



Atlanta Attachment Company

The Company that
Sudden Service
built

362 Industrial Park Drive
Lawrenceville, GA 30046 USA
+1 (770) 963-7369 • FAX +1 (770) 963-7641

APS

Automated Parts Management System

- Multi-access drawer modules
- High storage capacity with minimal footprint
- 24/7 secure access
- Touchscreen interface
- Emergency override in case of power failure
- Modular design/easily configurable
- Expandable add-on units
- Comprehensive reporting
- Automated replenishment

Images may include options.



APS1



Modular Design



APS3



APS2

MMCAB

Modular Parts Management System

- Reduce down time by locating organized parts more quickly and efficiently
- Reduce labor time in placing orders
- Reduce shipping charges by consolidating orders
- Minimal square footage required
- Detailed schematics with part numbers
- Modular design

Our modular design, not only saves valuable shop space, it will help your staff organize inventory and reduce total maintenance cost.



Partitioned areas with part numbers allow for easy location and to quickly see inventory.

Each drawer has a detailed drawing located on the inside of the lid with part numbers indicated and areas highlighted.

www.atlantt.com • sales@atlantt.com



Atlanta Attachment Company

The Company that
Sudden Service
built

Corporate Headquarters, Sales, Engineering & Service

Atlanta Attachment Company is a global supplier of sewing workstations, automated sewing equipment, folders, attachments and other labor saving devices for the apparel industry. Our equipment is built from the highest quality materials and with dedicated workmanship. The Atlanta Attachment brand is well known throughout the sewn products industry for its innovative technology.

Our line of apparel production equipment is developed for working with materials such as knit, woven and synthetic. A few of the many products sewn include placket shirts, circular collar and flat collar tee-shirts. AAC offers many sewing workstations for sweatshirts, sweatpants, and hooded sweatshirts. Equipment is also available for producing mens and ladies underwear, blouses and pajamas. More equipment is available for sewing drapery, caps and aprons. Multi-head embroidery equipment can be used for items needing personalization.

AAC stocks a wide variety of sewing machine attachments and folders but from it's inception has specialize in custom sewing machine folders. The Atlanta Parts Depot division delivers one-stop shopping for replacement sewing machine parts.

Our manufacturing facility in Lawrenceville Ga, USA is capable of handling any type of fabrication needed for our equipment.

- Engineering & Design
- Mechanical Assembly
- Electronic Assembly
- Electrical Assembly
- Sub-assembly
- CNC Milling up to 120"
- CNC Lathe
- Manual Milling
- Manual Lathe
- Surface Grinding
- Metal Fabrication
- Metal Finishing
- Tube Bending
- Cutting: Laser, Plasma, Water Jet
- Heat Treating
- Welding
- Painting
- Warehousing
- Distribution & Installation





Location

362 Industrial Park Drive
 Lawrenceville, GA 30046 USA
+1 (770) 963-7369
FAX +1 (770) 963-7641

Atlanta Attachment Company

is a recognized sewn products industry leader in automated workstations, labor saving devices, folders and ergonomic risk reduction. The company, founded in 1969, has made its policy of **Sudden Service**® a way of life in all aspects of operation.



QR Code for quick accesses to our location in google maps.

Sales & Technical Support

Sales



Hank Little
President



Doug Guffey
VP Sales
VP Ventas



Eugenio Fonts
VP International Sales



John Price
VP Folder Division



Randy Clark
VP Midwest Sales



Darrell Miller
Regional Sales Manager



Eric Iverson
Regional Sales Manager

Inside Sales



David Wall
Inside Sales
Ventas Internas



Michael Leathers
Inside Sales
Ventas Internas



Julie Garcia
Inside Sales
Ventas Internas





The "A" Team



William Richey
VP Customer Service



Jurgen Van Osch
Service Manager



Faye Williams
Customer Service
Executive Assistant



Jeff Moore
Service Technician



Jim Loewen
Service Technician

Technical Support

Languages Represented:
Other than English



Jose Ortiz
Service Technician



Brett Button
Service Technician



Craig Reichart
Service Technician



Justin Ozbolt
Service Technician



John Rogers
Product Specialist
- Furniture

 Portuguese

 German

 Dutch

 Afrikaans

 Spanish



Roberto Fernandez
Service Technician



Adam Broich
Service Technician



atlatt.com
sales@atlatt.com
phone +1 (770) 963-7369
fax +1 (770) 963-7641

362 Industrial Park Drive
Lawrenceville, GA 30046 USA

a Division of
HSM

© 2019 Atlanta Attachment Co.