

# USER MANUAL



Thank you for purchasing the  
Wadax Atlantis Reference Server.  
Please take some time to read this  
manual.



# Index

---

■ Preliminaries	4
■ Connections and Controls	6
■ System boot: Roon setup	19
■ Setup of the Audio DAC	21
■ Optimizing performance - tuning of the digital link	25
■ About Roon	29
■ Library Management from a Computer	31
■ Adding new media to the library	35
■ Warranty	36
■ Specifications	37

## SETUP AND INSTALLATION

---

### PRELIMINARIES

The setup of Atlantis Reference Server is easy and straight forward.

The following will be needed:

- Internet connection with RJ45.
- A DAC
- A power socket or an external power supply.
- A Roon control point: many different controllers can be used.
- A Roon active subscription.

They can be checked and downloaded here: <https://roonlabs.com/>

- Depending on the DAC, either a Wadax Akasa Optical, or USB cable will be required.

## WARNING!

Make sure your Atlantis Reference Server is set for the line voltage. Internally there are switches for 100-110-220V. Please ask your dealer for servicing.



## SETUP AND INSTALLATION

### CONNECTIONS

---

**Warning!** Always remember that a plug with bared connectors is dangerous if in contact with a live socket. This appliance must be earthed. Connect a certified power cord to the back of the power supply and plug it into the nearest wall plug or power distributor. Use only a grounded plug, for safety and noise reasons. Please ask your Wadax dealer if there is any doubt or technical question.



---

**Warning!** Take care to always handle the cable by the connectors. Never twist the cable excessively or attempt to connect or disconnect the connector by handling the cable body in place of the connector.



---

**Warning!** Everytime there is a cable change, please turn off the rest of the audio equipment.



# SETUP AND INSTALLATION

## CONNECTIONS AND CONTROLS

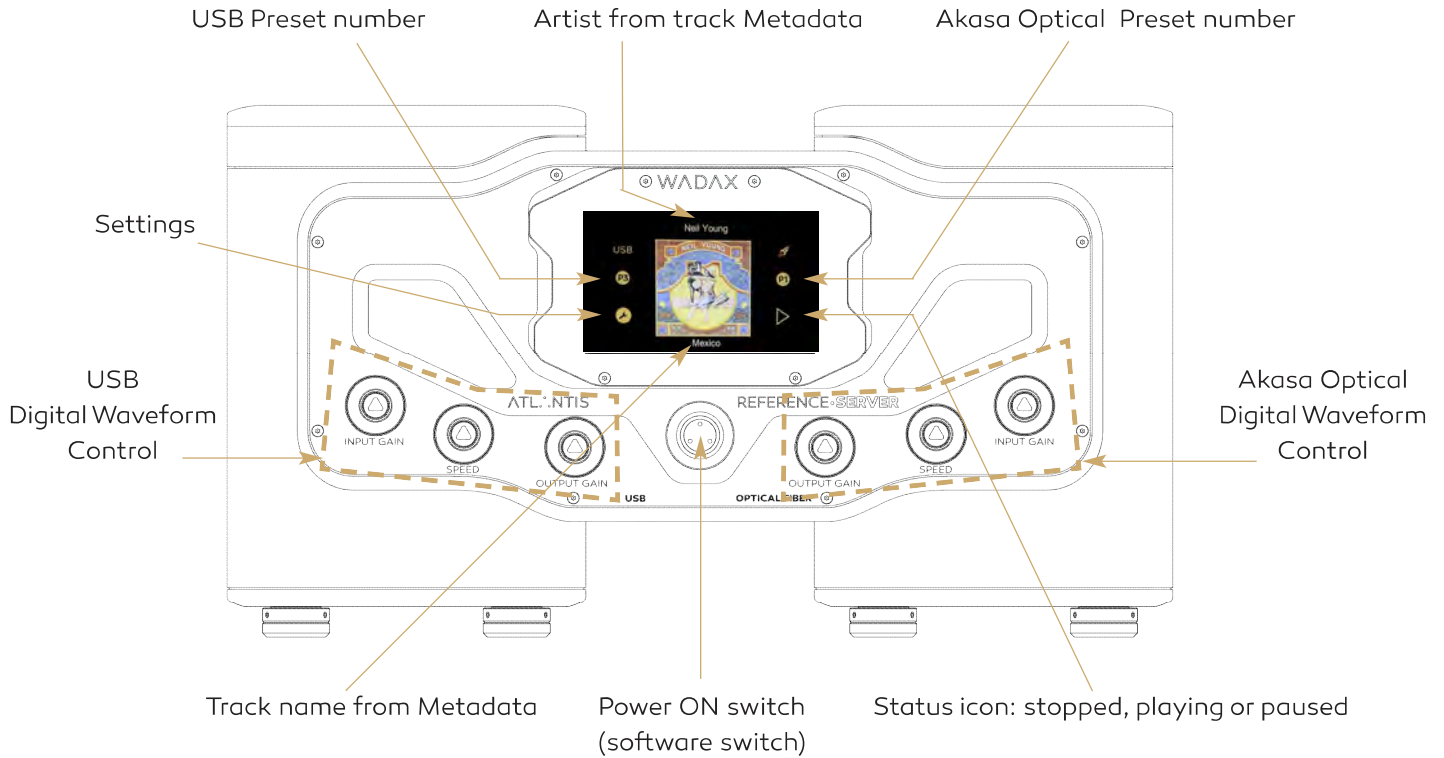

# SETUP AND INSTALLATION

## CONNECTIONS AND CONTROLS

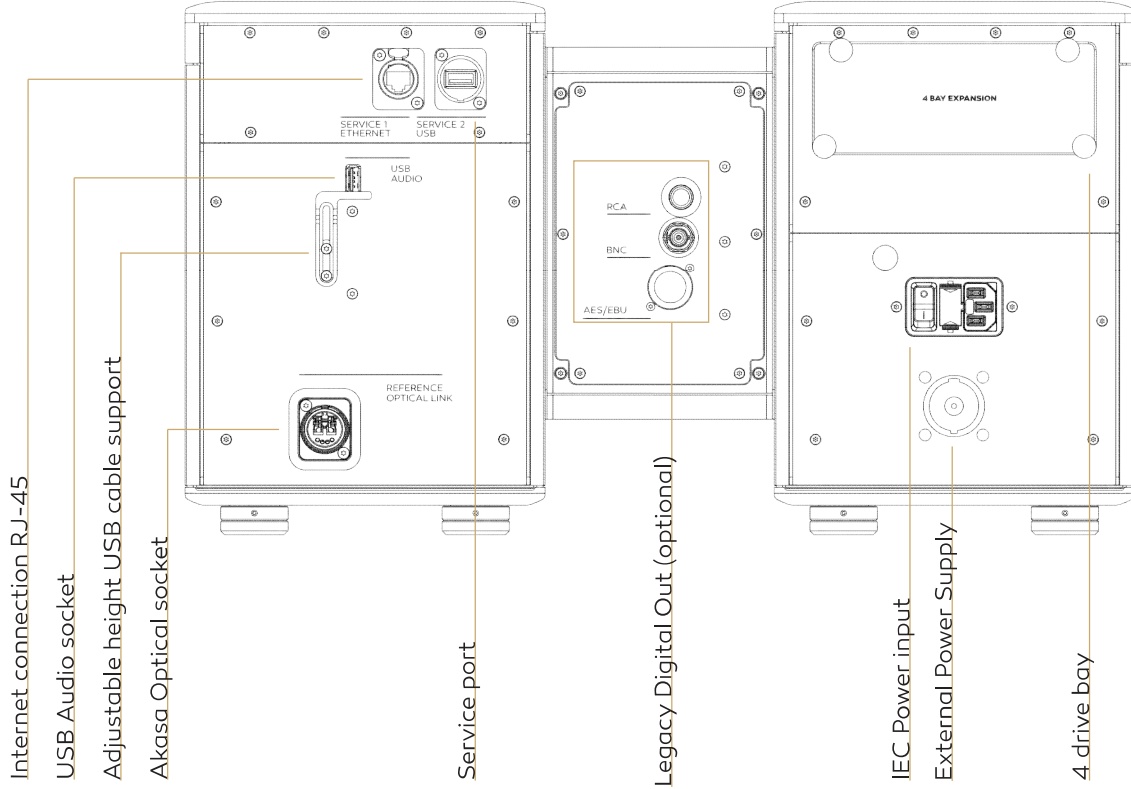

## SETUP AND INSTALLATION

### CONNECTIONS AND CONTROLS

- 1 Please connect an Rj-45 Cable with Internet access to the port labeled 'Internet'. Connect an ethernet cable from Internet socket to the router. Then connect an Ethernet cable from router to the socket labeled 'Internet' at the back of **Atlantis Reference Server**, If there is no Internet access, the unit will not be functional.



- 2 **Connecting Atlantis Reference Server to a DAC:**  
6 different DAC options are possible, based on available connections and equipment.

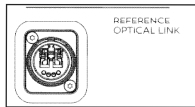

Akasa optical

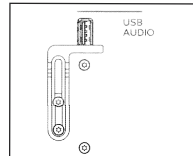

USB

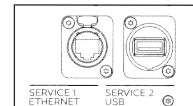

Ethernet

**3 sockets are involved in these combinations.**



# SETUP AND INSTALLATION

## CONNECTIONS AND CONTROLS

### REFERENCE SERVER CONNECTED TO REFERENCE DAC

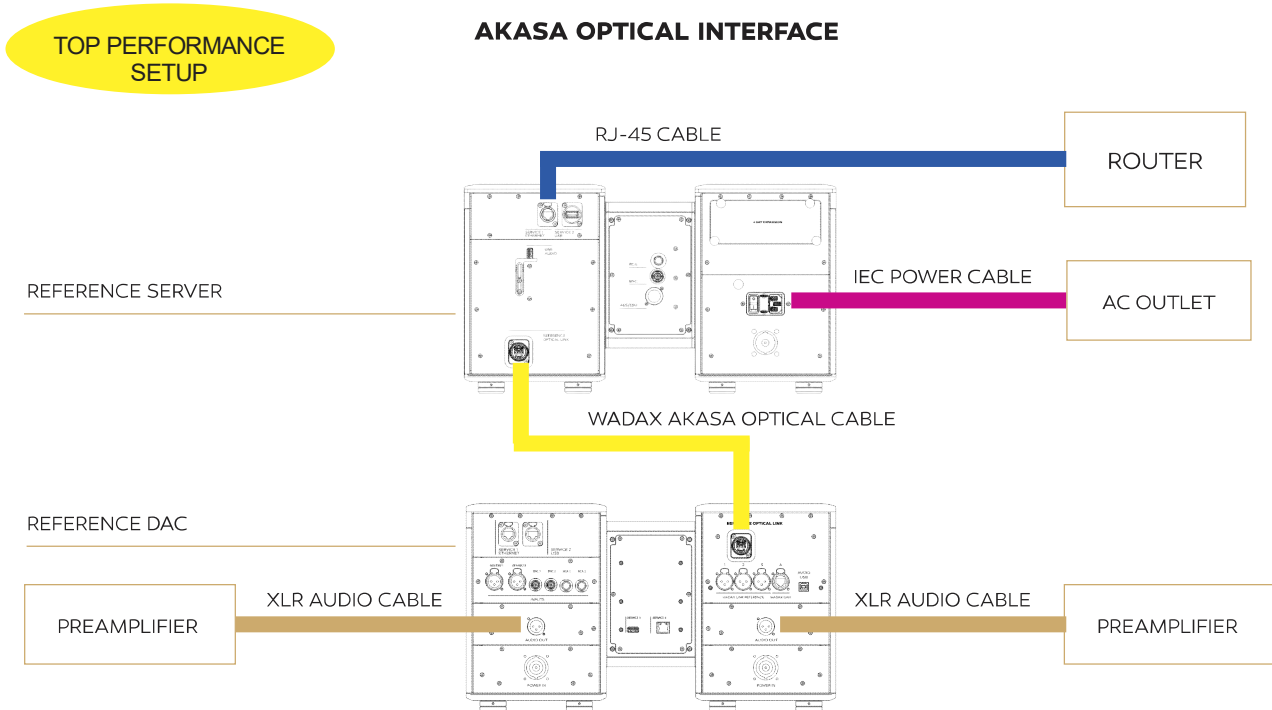

# SETUP AND INSTALLATION

## CONNECTIONS AND CONTROLS

### REFERENCE SERVER CONNECTED TO REFERENCE DAC

#### USB INTERFACE

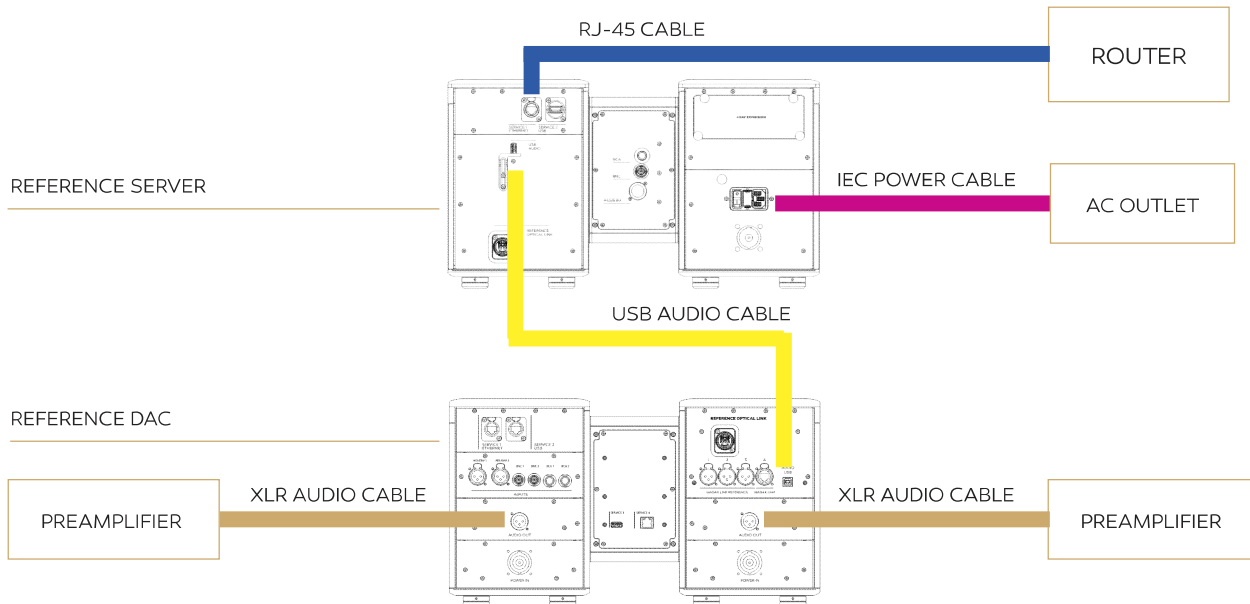

# SETUP AND INSTALLATION

## CONNECTIONS AND CONTROLS

### WARNING!

DO NOT CONNECT BOTH USB  
AND OPTICAL SIMULTANEOUSLY



### REFERENCE SERVER CONNECTED TO REFERENCE DAC

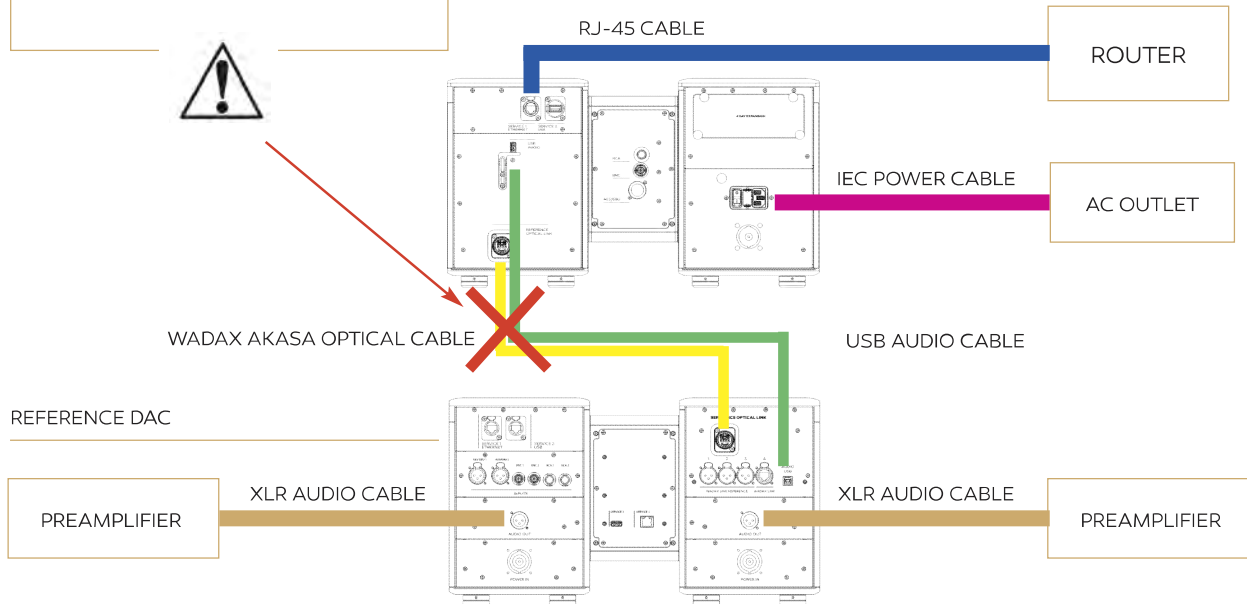

# SETUP AND INSTALLATION

## CONNECTIONS AND CONTROLS

### REFERENCE SERVER CONNECTED TO ATLANTIS DAC

#### USB INTERFACE

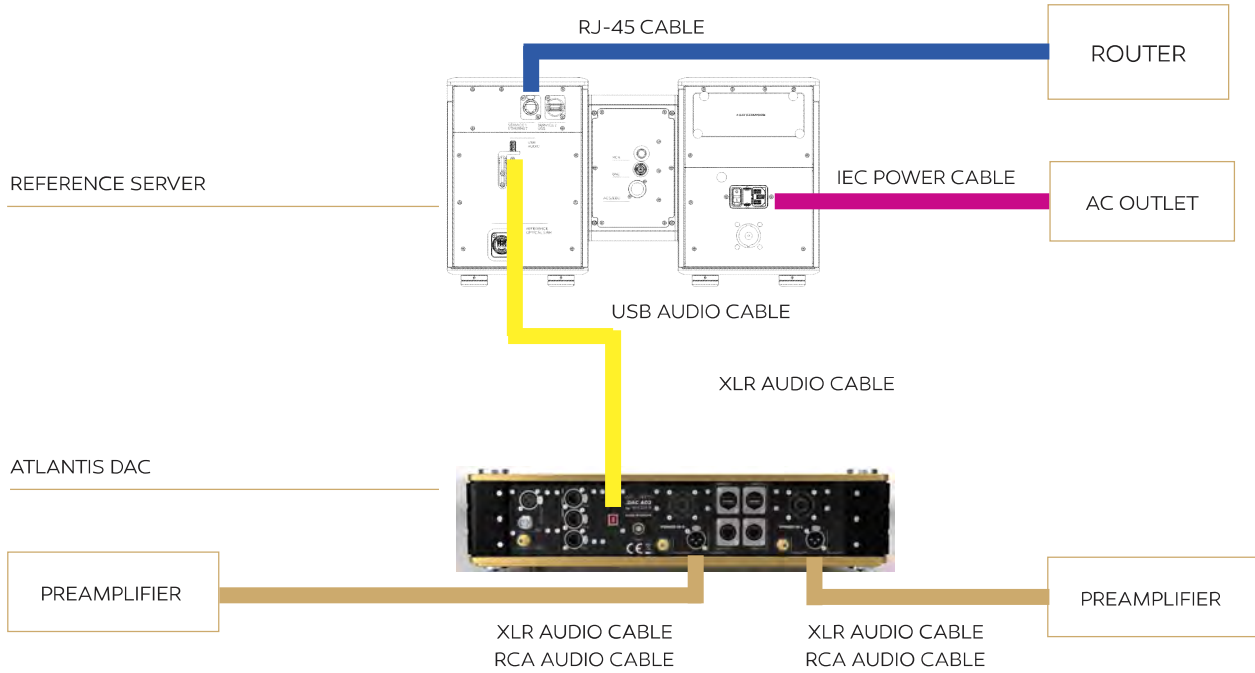

# SETUP AND INSTALLATION

## CONNECTIONS AND CONTROLS

### REFERENCE SERVER CONNECTED TO USB DAC

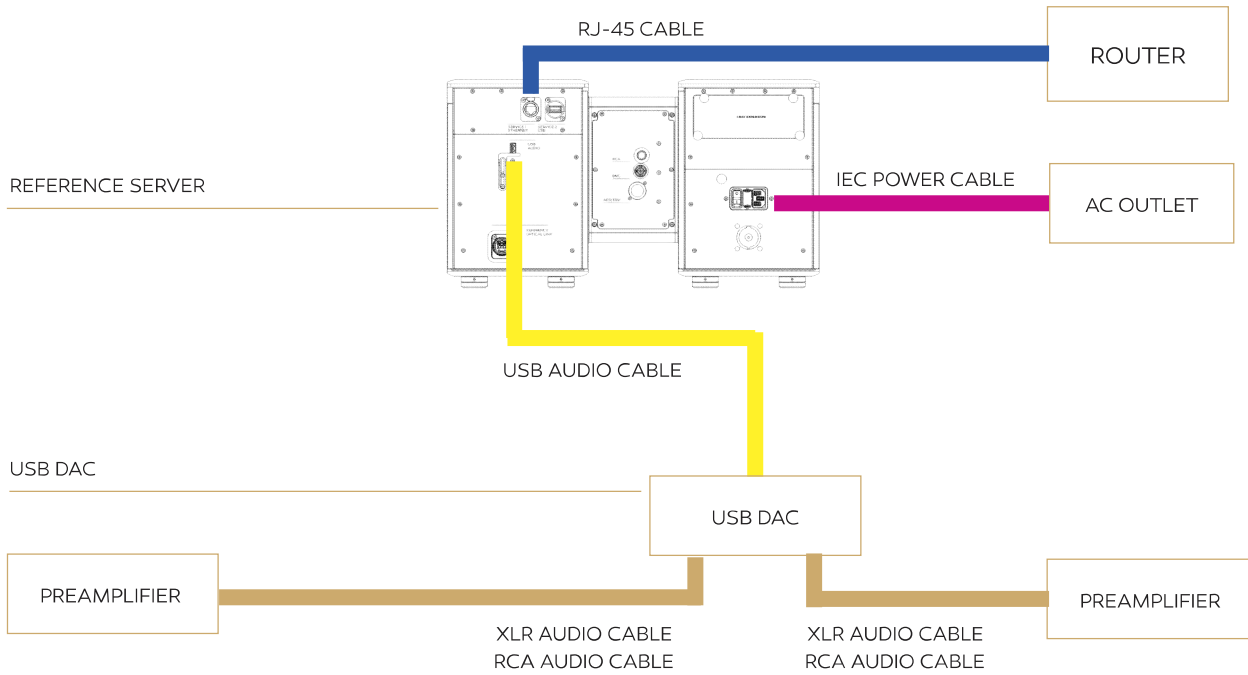

## SETUP AND INSTALLATION

### CONNECTIONS AND CONTROLS

#### REFERENCE SERVER CONNECTED TO STREAMING DAC

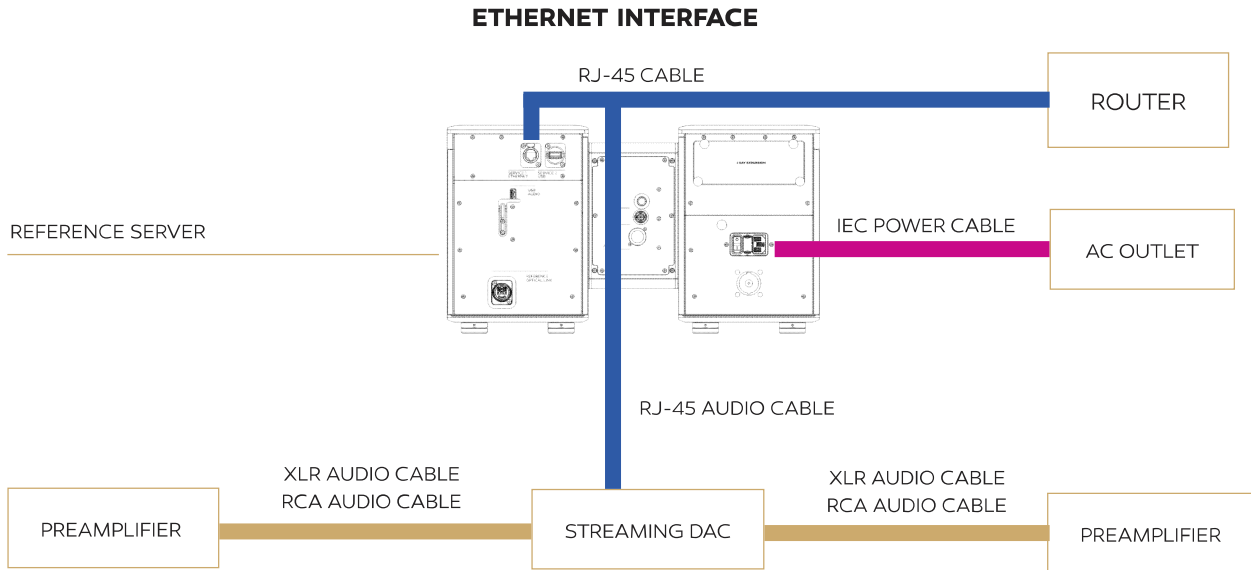

For streaming Room Ready DACs, just need to make sure the DAC is connected to the same network as the Server.

# SETUP AND INSTALLATION

## CONNECTIONS AND CONTROLS

### REFERENCE SERVER CONNECTED TO UNIVERSAL DAC (ONLY IF REFERENCE SERVER IS EQUIPPED WITH LEGACY DIGITAL OUTPUT)

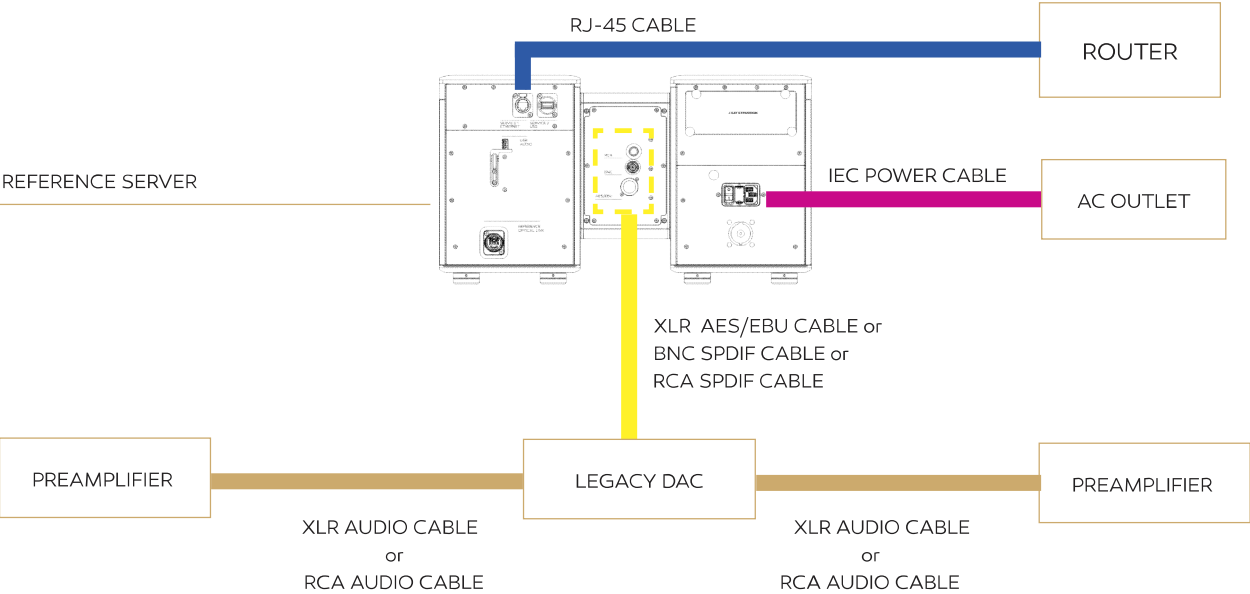

## SETUP AND INSTALLATION

### CONNECTIONS AND CONTROLS

### 3 USB adjustable cable support

Many USB audiophile cables on the market are bulky and heavy. A dangerous torque over a prolonged period of time can stress and eventually damage a USB socket.

For this purpose, Atlantis Reference Server incorporates an adjustable-height support that will add mechanical strength and secureness to the connection.

To adjust the height, use a Torx T10 screw driver. Release the 2 screws. Then move to the desired height and screw up again.

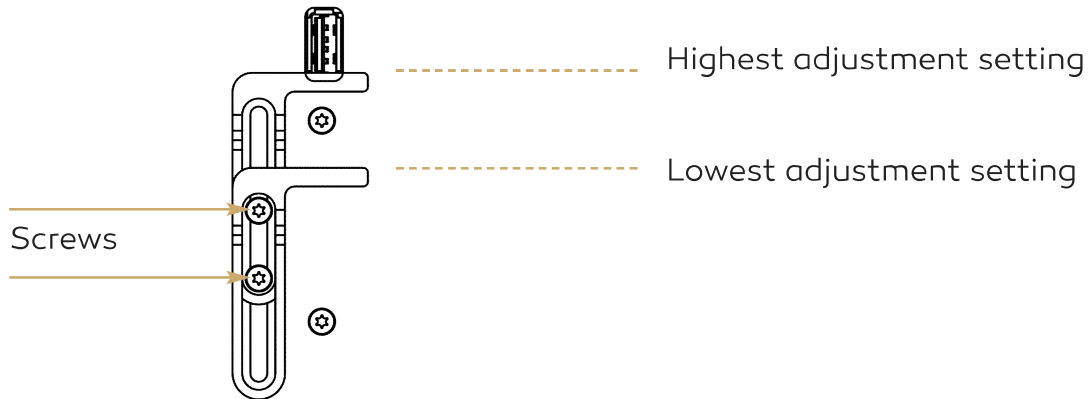



## SETUP AND INSTALLATION

### CONNECTIONS AND CONTROLS

# 4

**Connecting Atlantis Reference Server to any DAC using the optional Legacy board:**

Outputs: AES/EBU, SPDIF RCA and SPDIF BNC.

Note all 3 outputs are associated to the same zone in Roon. Means the same music content selected will be played simultaneously in all 3 outputs.

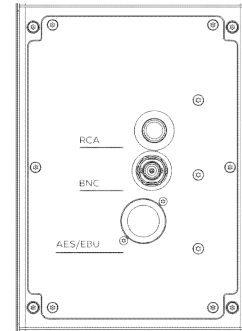

# 5

**The final step is to connect power.  
There are 2 options.**

**Option A: use the internal power supply.**

An IEC connector is required. Connect the power cable.

Do NOT connect any cable on the “external power supply” socket if this Option A is used. Then press on the power switch.

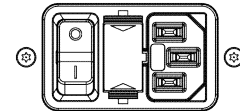

## SETUP AND INSTALLATION

### CONNECTIONS AND CONTROLS

---

#### **Option B: use the external power supply.**

A Wadax Akasa DC cable should be used for this option.

Do NOT connect any cable on the IEC connector if this Option B is used. You can power on the external power supply at this stage.

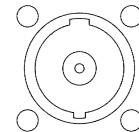

## WARNING!

DO NOT CONNECT A REFERENCE DAC PSU TO THIS EXTERNAL POWER SUPPLY SOCKET.  
IN SUCH A CASE, THERE IS A HIGH RISK THAT BOTH WILL BE DAMAGED.



## SETUP AND INSTALLATION

### SYSTEM BOOT: ROON SETUP

6

**The normal boot sequence takes about 2 minutes.**

After the power switch has been turned on, it will start booting. There is no need to press the front power button to start the server. After the server completes the boot phase, it will display the home screen. To power down, it can either be done using power switch at the back or use the front button. The front button is a software managed button. It provides an ordered and managed power off and on of Atlantis Reference Server. **It may take up to 30 seconds to power down.**

## WARNING!

If the server cannot find a valid Internet connection, it will display the message 'No internet' on screen and startup will be paused. As soon as it finds an Internet connection, it will resume startup.



## SETUP AND INSTALLATION

### SYSTEM BOOT: ROON SETUP

## WARNING

The following steps are based on Roon version 1.8. Other versions may have different configuration settings or windows.



## 7 **Connect your controller to the same wired or WiFi network as Atlantis Reference Server. Run Roon controller.**

The Server should be found within a few seconds.

If the setup is done for the first time, the first step is to enter Roon credentials. **Previously, a Roon account should be created or be active.**

Roon credentials are an e-mail address and a password.

## SETUP AND INSTALLATION

### SETUP OF THE AUDIO DAC

The Wadax Atlantis Reference Server incorporates a unique technology to optimize digital audio data transmission from the Server to the DAC.

# 8

## Setup audio devices

The next step is to setup audio DACs connected to Atlantis Reference Server.

This can be done inside settings and audio tabs.

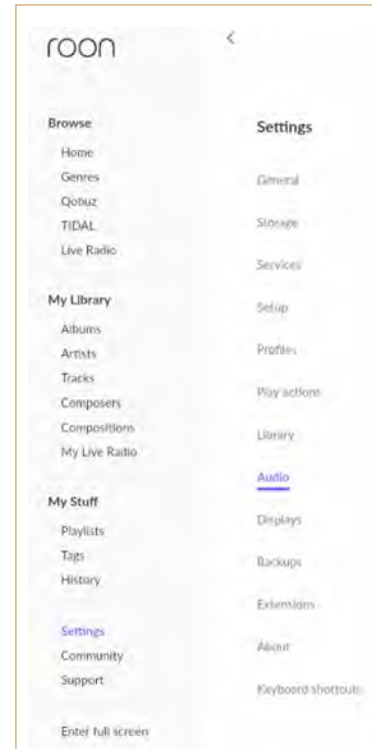

## SETUP AND INSTALLATION

### SETUP OF THE AUDIO DAC

# 9

#### Setup the DAC: Reference DAC

If a Reference DAC is connected to Reference Server, settings should be as shown in the image.

These settings are the same for both USB connection or Akasa Optical connection.

## WARNING!

Reference DAC can be connected with Reference Server with 2 different interfaces: Akasa Optical and USB. Only 1 of them can be plugged simultaneously to Reference DAC.

Wadax strongly recommends Akasa Optical interface as the optimal connection between Reference DAC and Reference Server.

To change between interfaces, please power system off, change cabling and power on. Then select the corresponding input in Reference DAC.

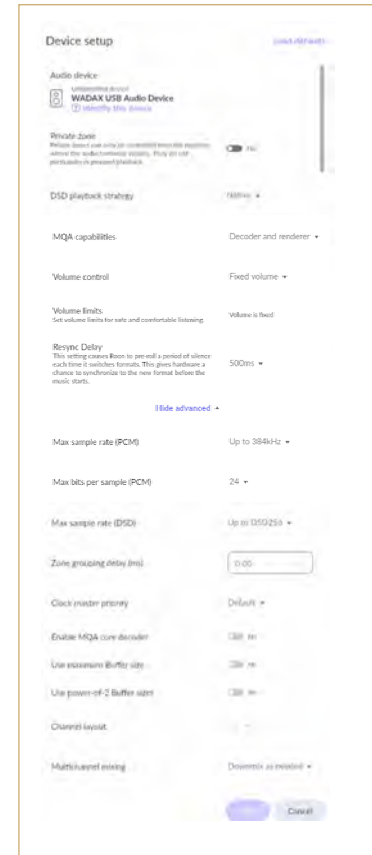

## SETUP AND INSTALLATION

### SETUP OF THE AUDIO DAC

# 10

#### Setup check: Extension enable check

Atlantis Reference Server incorporates several proprietary technologies. One of them is a Wadax extension for Roon. Its called '**Reference Server Proxy**' and it should be visible in the **Extensions** section in Setup menu. There should be no other icon at the right part, like '**Enable**' or '**Pair**'. This is how it should look like for correct functionality of Atlantis Reference Server:

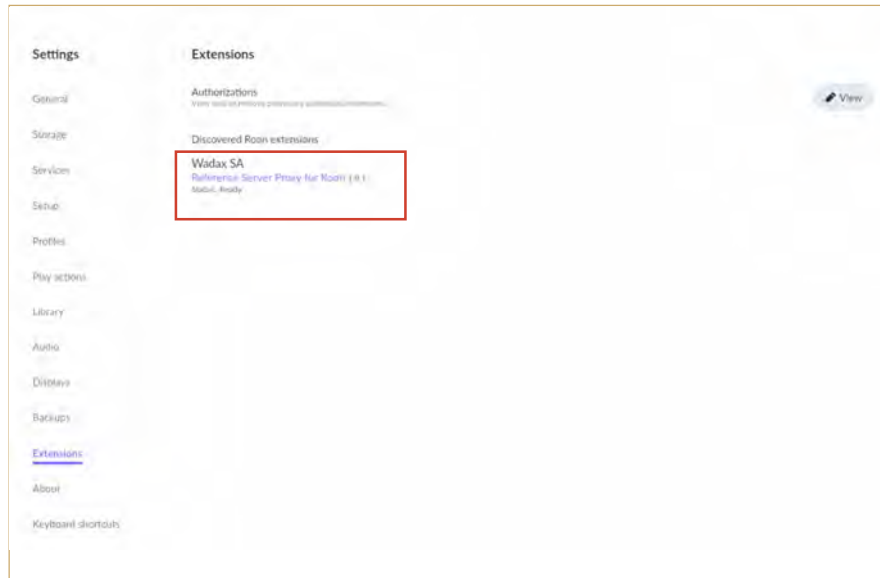

## SETUP AND INSTALLATION

### SETUP OF THE AUDIO DAC

# 11

#### Setup check: Extension enable check

Roon is updated automatically every time there is a new version or build. Some updates could eventually change some settings, like disabling the Wadax proprietary '**Reference Server Proxy**'. If this occurs, inside **Settings -> Extensions**, there would be a button called '**Enable**', as seen in picture below.

Simply click on '**Enable**' and it will get back to normal.

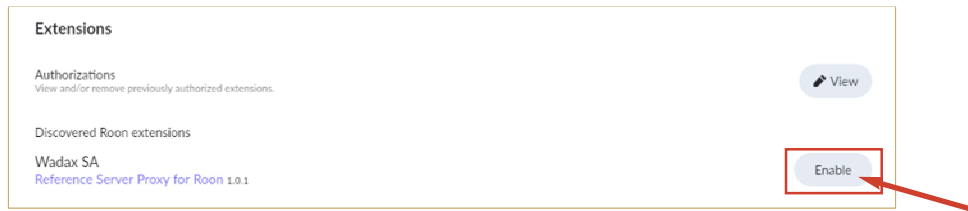

**If this extension is disabled, the front display of Atlantis Reference Server will show this image:**

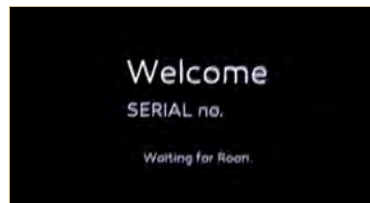



# 12 Atlantis Reference Server incorporates a unique technology to optimize digital audio transfer between Server and DAC.

This technology is applicable to Akasa Optical interface and USB interface. A White paper will soon be published by Wadax about this technology and the unique improvements it brings to digital audio playback.

In the front panel of Atlantis Reference Server there are 2 sets of 3 rotary controls. The set on the left controls USB interface. The set on the right controls Akasa Optical interface.

Each set is composed of 3 controls.

They are labeled:

- **Speed:** controls the rise time of the bit waveforms. This does not change bit content, only the shape of the bit edge.
- **Input Gain:** controls input sensitivity of the digital stream in the control loop DAC to Server. This control will never change bit content, 0's will still be 0's and 1's will still be 1's.
- **Output Gain:** controls the voltage value of bits in high level. This control will never change bit value in audio tracks: 0's will still be 0's and 1's will still be 1's.

## SETUP AND INSTALLATION

### OPTIMIZING PERFORMANCE - TUNING OF THE DIGITAL LINK

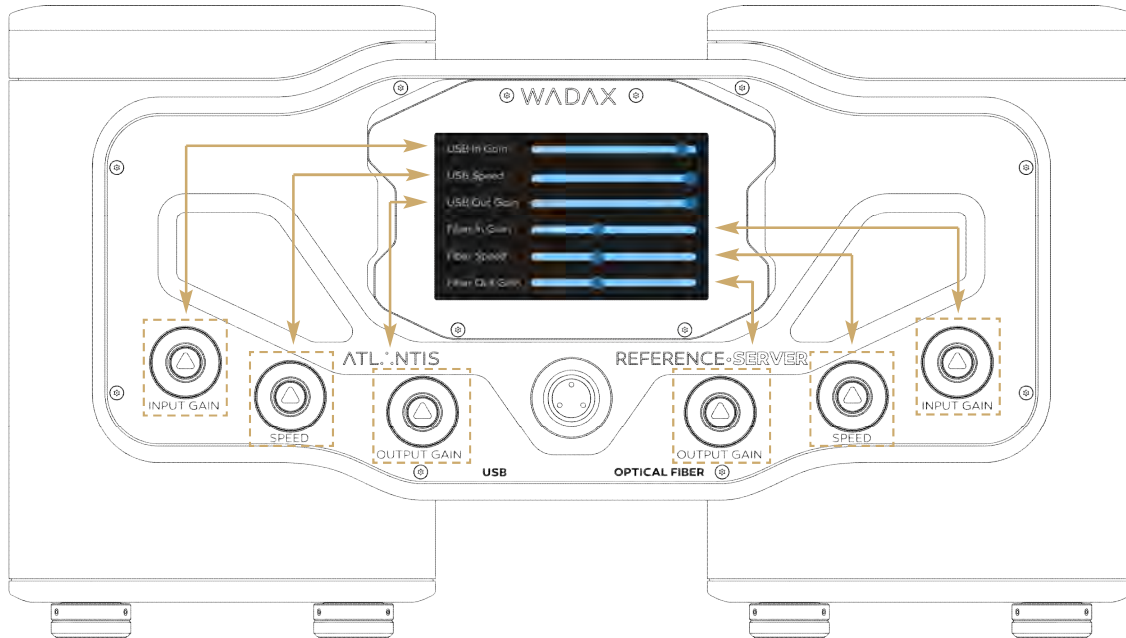

Each rotating button controls a digital waveform parameter. When a button is turned, the main display with track image will change to the digital waveform settings display.

## SETUP AND INSTALLATION

### OPTIMIZING PERFORMANCE - TUNING OF THE DIGITAL LINK



Rotating each encoder changes the corresponding digital waveform parameter setting. Its value is represented by the slider pointer. Minimum is at the left side. Maximum is at the right side.

When the slider is set to minimum, there is no digital waveform correction applied. When the slider is set to maximum, digital waveform correction is at the top level.

## WARNING!

Wadax recommends not to exceed correction amount over 75% of total slider length. The reason is that the digital link can be desynchronized and playback may not be stable, stopping or pausing. If this is the case, moving the slider to the left should make the digital interface to lock again. This is also safe to do and no damage should occur to the system.

**If correction value is over 75%, the slider bars will change colour to red.**



## SETUP AND INSTALLATION

### OPTIMIZING PERFORMANCE - TUNING OF THE DIGITAL LINK

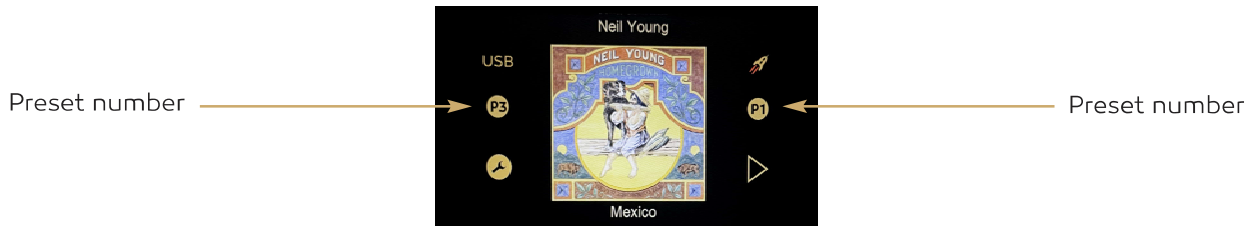

After all 3 settings are adjusted, they can be stored in 3 presets for USB and 3 presets for Akasa Optical link. These presets can be recalled at anytime during playback, for quick A-B.

To store a slider setting, keep a button pressed for 2 seconds. Each button represents a preset.

After each preset is saved, the message “**FIBER PRESET x SAVED**” / “**USB PRESET x SAVED**” on display will be displayed. ‘x’ can be 1,2 or 3.

To load a preset, a short press on each button will load settings stored in a specific preset. The active preset can be seen as an icon on the display. It can be P1, P2, P3.

## SETUP AND INSTALLATION

---

### ABOUT ROON

**13** Wadax selected Roon as its core server software. The reason is performance, large supporting community, customizing capability, and continuous evolution of features.

Given this continuous evolution of Roon, Wadax does not include Roon operation in Atlantis Reference Server user manual. It would become obsolete quickly.

Therefore the best way to stay up to date in visiting this online user guide at Roon's website:

**<https://help.roonlabs.com/portal/en/kb/roon-labs-llc>**

## SETUP AND INSTALLATION

---

### LIBRARY MANAGEMENT FROM A COMPUTER

#### **Organize the metadata of your library:**

Like in the 'real' world, can be organized, documented and structured, or can be undocumented or unorganized or unstructured. During developmental stage we observed that at least one of these three characteristics was found in most of the music libraries from users. This can diminish the user experience to a great degree. In the past it was frequent to see music library drives that had corrupt tracks, incorrect metadata or other issues that can bring instability to the streaming experience if not filtered previously.

#### **Use SSD (Solid State Drives) instead of mechanical Hard Drives:**

At the same time, usability and performance diminishes if mechanical hard drives or usb storage are used for the storage. So we strongly advise to use SSD for any drive inserted into the bays. Also avoid the use of external NAS, if possible.

Regarding existing libraries, the user's computer is the front-end for data input. The user will connect pen drives, hard drives, etc to their computer. It is of course necessary that the computer be in the same network as the server.

## SETUP AND INSTALLATION

### LIBRARY MANAGEMENT FROM A COMPUTER

If the user's computer is **WINDOWS** based:

1. Open EXPLORER and choose 'MAP NETWORK DRIVE'.

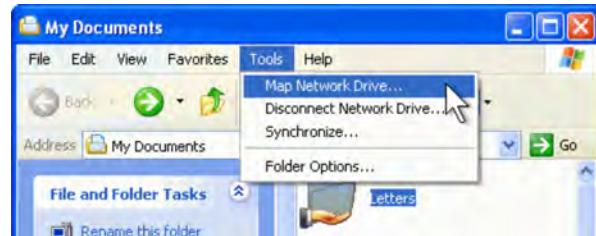

2. A window will pop up. Click on 'Reconnect at logon' and 'Connect using a different user name'. In folder box type:

**\\Reference-Server-XXX\music**

where **XXX** is the serial number of Reference Server. This can be checked on the top plate or the back label.

A credentials window will appear. Please use:

user: **atlantis**

password: **atlantis2021**

3. The Atlantis Library folder will now be part of your desktop.

The rest is drag and drop.

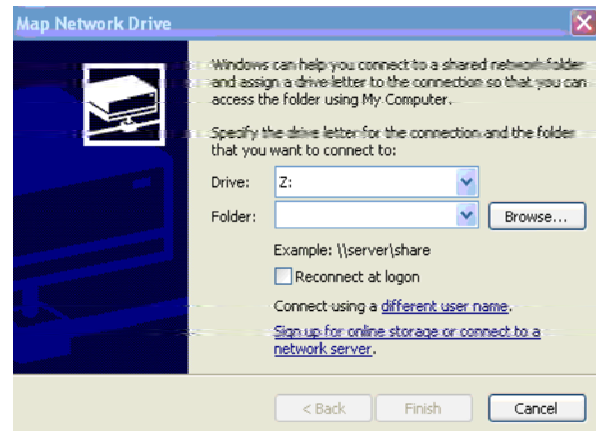

# SETUP AND INSTALLATION

## LIBRARY MANAGEMENT FROM A COMPUTER



1. In the Finder, choose 'GO'. Then 'CONNECT TO SERVER'.

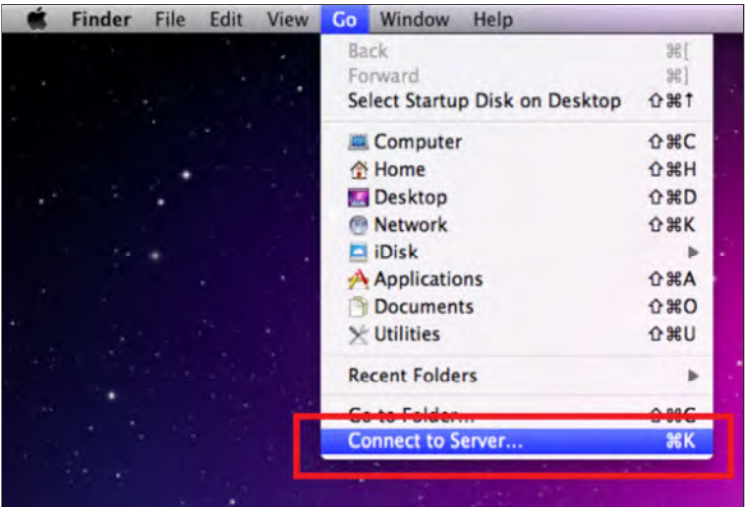



## SETUP AND INSTALLATION

### LIBRARY MANAGEMENT FROM A COMPUTER

2. In server address type:

**smb://reference-server-XXX/music'**

where **XXX** is the serial number of Reference Server. This can be checked on the top plate or the back label.

3. When prompted use:

user: **atlantis**

password: **atlantis2021**

4. Click '+' to add to favourite server.

5. The library will now be seen in the desktop. Please follow normal drag and drop practices to manage the library.

All music copied will be automatically detected by Roon and accesible from the control point.

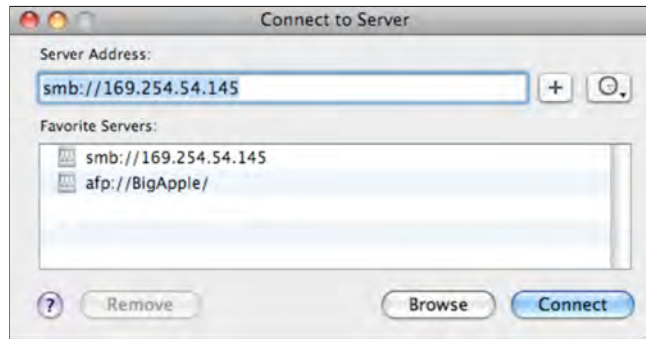

## **SETUP AND INSTALLATION**

---

### **ADDING NEW MEDIA TO THE LIBRARY**

#### **ABOUT PENDRIVES, HARD DRIVES AND ONLINE MUSIC.**

Due to the reasons explained before, the user's computer will be the front end for library management. Whether it's a pendrive, a hard drive or an online download, please handle it at your computer and drag and drop the desired files to the library folder.

#### **HOW TO ADD STORAGE TO ATLANTIS REFERENCE SERVER**

If extra storage is needed, 4 expansion bays are provided. Only qualified SSDs are advised. Atlantis Reference Server is only recommended with SSD, no traditional hard drives. If more space is needed, an external NAS populated with SSD is recommended. Please ask your dealer.

#### **WARM UP**

Wadax does not recommend critical listening until 24 hours from power on.

---

#### **CLEANING**

Use a soft, dry cloth to wipe dust off the music system. Do not use liquid cleaners or aerosol cleaners. Wipe dust off the surfaces using a dry, soft cloth. To remove stains or dirt, use a soft, damp cloth and a solution of water and mild detergent, such as washing-up liquid.

## **Waste Electrical and Electronic Equipment (WEEE) Environmental protection**

The European Parliament and the Council of the European Union have issued the Waste Electrical and Electronic Equipment Directive. The purpose of the Directive is the prevention of waste of electrical and electronic equipment, and to promote the reuse and recycling and other forms of recovery of such waste. As such the Directive concerns producers, distributors and consumers.



The WEEE directive requires that both manufacturers and end-consumers dispose of electrical and electronic equipment and parts in an environmentally safe manner, and that equipment and waste are reused or recovered for their materials or energy. Electrical and electronic equipment and parts must not be disposed of with ordinary household refuse; all electrical and electronic equipment and parts must be collected and disposed of separately. Products and equipment which must be collected for reuse, recycling and other forms of recovery are marked with the pictogram shown.

When disposing of electrical and electronic equipment by use of the collection systems available in your country, you protect the environment, human health and contribute to the prudent and rational use of natural resources. Collecting electrical and electronic equipment and waste prevents the potential contamination of nature with the hazardous substances which may be present in electrical and electronic products and equipment.

Your Wadax retailer will assist with and advise you of the correct way of disposal in your country.

## WARRANTY

---

**Wadax warrants Atlantis Reference Server with a 3 year period from the date the unit was originally shipped from the factory.**

During the warranty period, Wadax will cover parts and labour of the repair.

Please contact your dealer if your unit requires service.

## SPECIFICATIONS:

### Atlantis Reference Server

---

**Power consumption ON/Stand-by:** 100W/<7W

**Inputs/Outputs:**

USB

Wadax Akasa Optical Link

Ethernet RJ-45

AES/EBU, RCA, BNC\*

\*These outputs are only available if Atlantis Reference Server is equipped with the optional 'Digital Output Board'.

**User interface:** 5 inch capacitive touch full-colour display 800x480.

**Storage:**

**Internal:** 2TB SSD PCI-E M.2

**Externally accessible:** 4 bays 2.5 inch. Any drive size is supported.

**Power:** 100V/110V/220V, switchable internally by a Wadax certified technical service.

**Service port:** USB.

---



This product is in conformity with the provisions of the Directives 1999/5/EC and 2006/95/EC.

**SPECIFICATIONS:**

**Atlantis Reference Server**

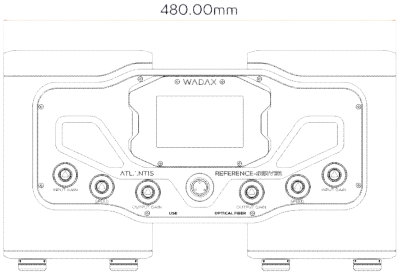
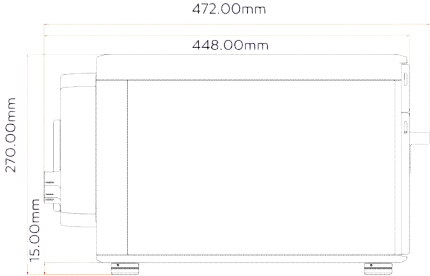

**Weight:** 48 Kg / 105,8 Lbs.

**Dimensions:**

- 480mm / 18,90 inches (Width)
- 270mm / 10,62 inches (Height)
- 472mm / 18,58 inches (Depth).

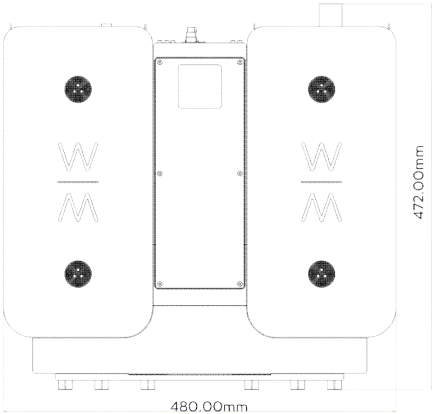



WADAX

[www.wadax.eu](http://www.wadax.eu)

---

[info@wadax.eu](mailto:info@wadax.eu)